

Fundamentals of Passive Optical LAN



Sean Kelly, RCDD



Matt Miller
CallisonRTKL

Chad Hines
IT Connect Inc.



Brought to you by the Association for Passive Optical LAN
(APOLAN)

Founding Members:



www.apolanglobal.org

Bicsi



Course Agenda

- Day 1
 - Passive Optical LAN: 101 – Sean Kelly, RCDD
 - Introduction to POL Components – Matt Miller
 - Introduction to POL Design with Hands-On – Chad Hines
- Day 2
 - Day 1 Review
 - Power Survivability – Chad Hines
 - POL Testing Considerations – Sean Kelly, RCDD
 - POL Integration and Management – Matt Miller
 - POL Project Closeout Package Deliverables – Matt Miller



I am a...

- A. Consultant
- B. Designer
- C. Contractor
- D. Manufacturer
- E. End User
- F. Other



My experience with POL is...

- A. I have installed one
- B. I have turned one up
- C. I have a project now
- D. I have some knowledge
- E. I am here to learn



Passive Optical LAN:101

Sean Kelly, RCDD



Bicsi



Section 1 Agenda

- Introduction to Passive Optical LAN
- Where did it originate
- Market adoption
- Knowledge Check



Let's Imagine...



A Local Area Network that...

This describes a traditional LAN!



An exciting new way...

Passive Optical LAN

The infrastructure of tomorrow available today



***“A Bandwidth Efficient LAN
Architecture Providing Measurable
CapEx & OpEx Savings”***

Bicsi



Thoughts...

Henry Ford Wisdom...

"If I'd asked customers what they wanted, they would have said "a faster horse."

Steve Jobs Wisdom...

"Man is the creator of change in this world. As such he should be above systems and structures, and not subordinate to them."



Would the legislature be able to prove a scientific method to a target?

"There aren't many horse and buggies on the road and most of us don't have typewriters sitting on our desks. So why are copper networks still so widely used although they have been rendered obsolete by next-generation technologies?" Scott Forbes, CEO Forbes Media

Bicsi



Key Acronyms

GPON

PON vs. POL

OLT and ONT



What is Passive Optical LAN?

Revolutionary

Economical

Efficient



What is Passive Optical LAN?

Standards
based/recognized
technology

ITU G984.x

ANSI/TIA 568C

BICSI TDMM 13

Fiber Based Local Area Network

Point to Multipoint Topology



Why Passive Optical LAN?

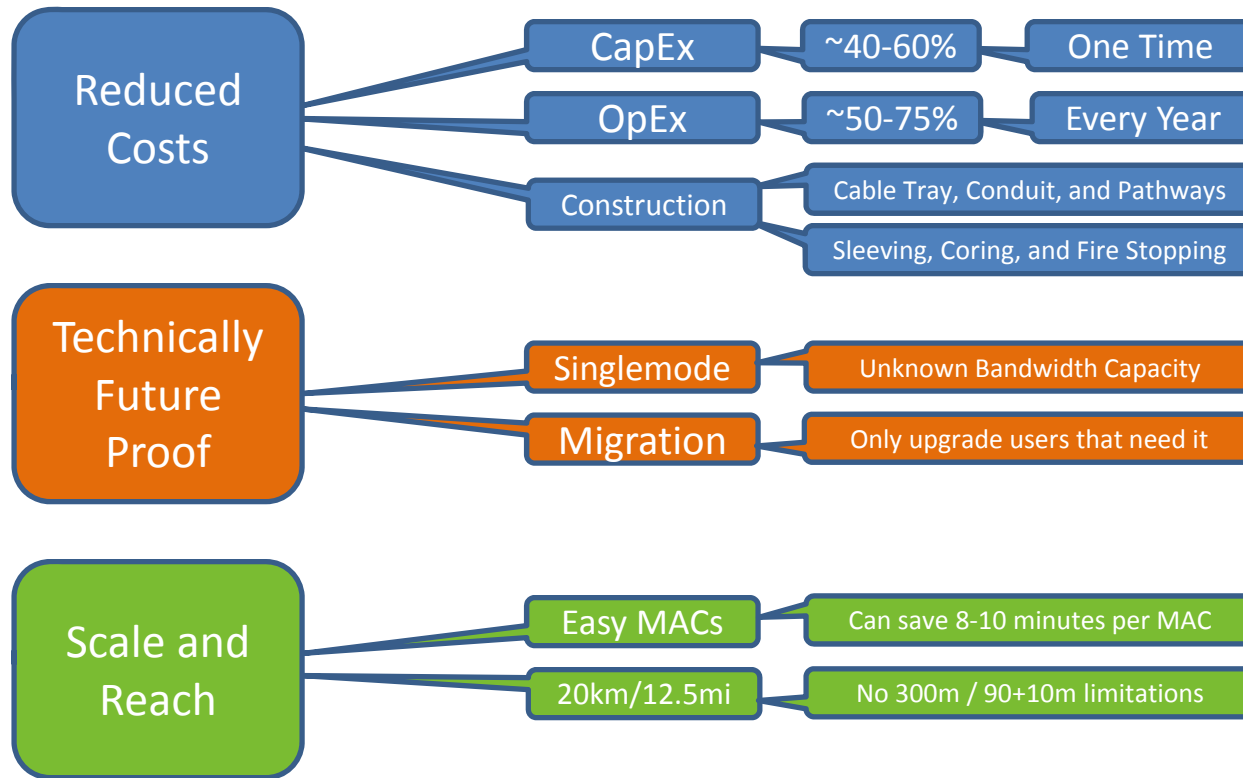

Why Passive Optical LAN?

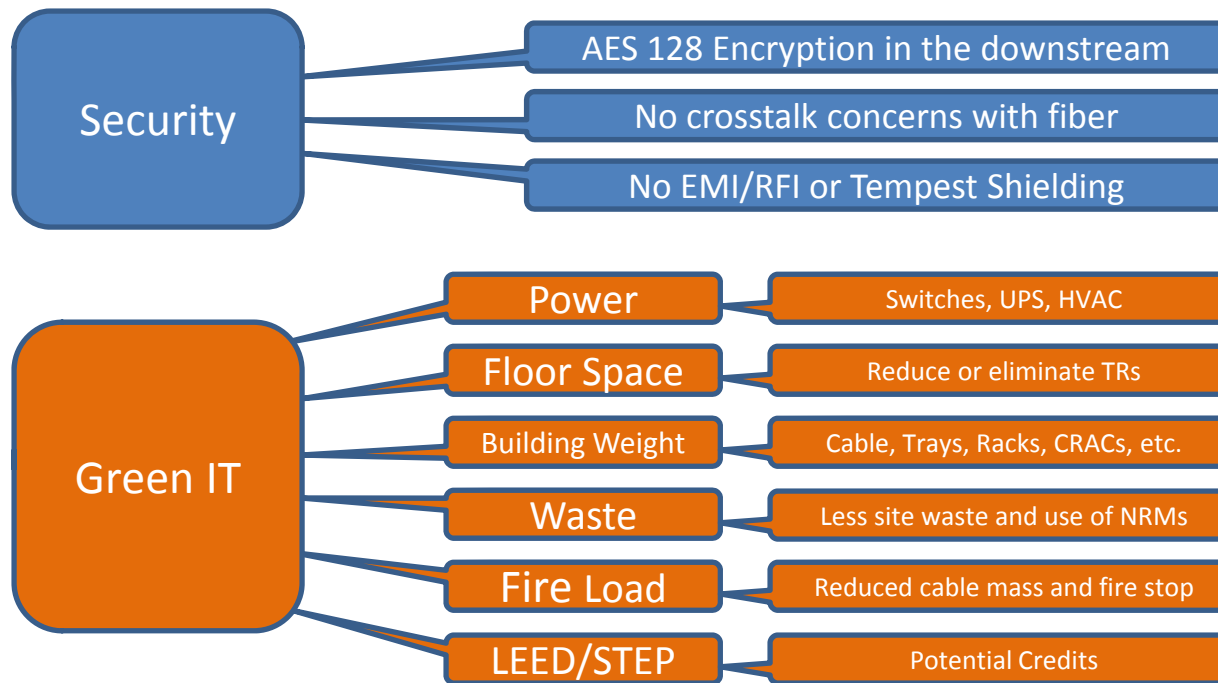

Why Passive Optical LAN?

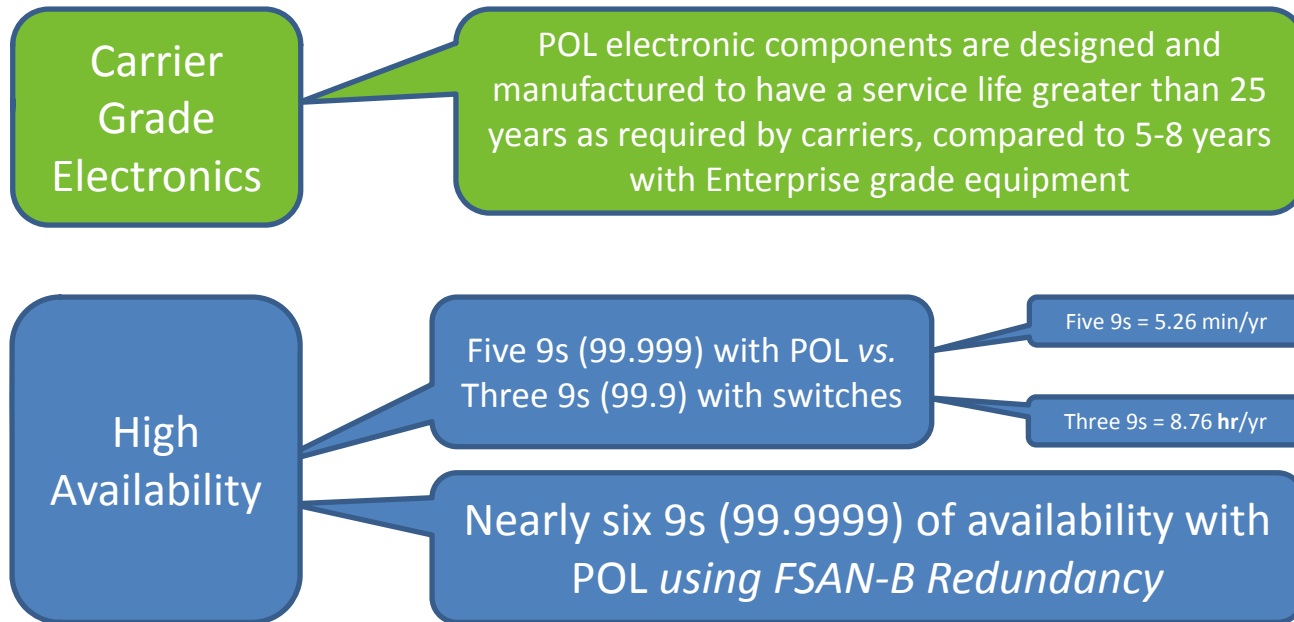

What should you know?

Similar

Standards Based

Local Area Network

Enterprise Management

Ethernet Frame Transport

802.1x – 802.1Q – PoE

Different

Point to Multipoint

Multiple Services

Guaranteed Bandwidth

Single Strand of SM Fiber

No Access and Distribution



Where did it come from?

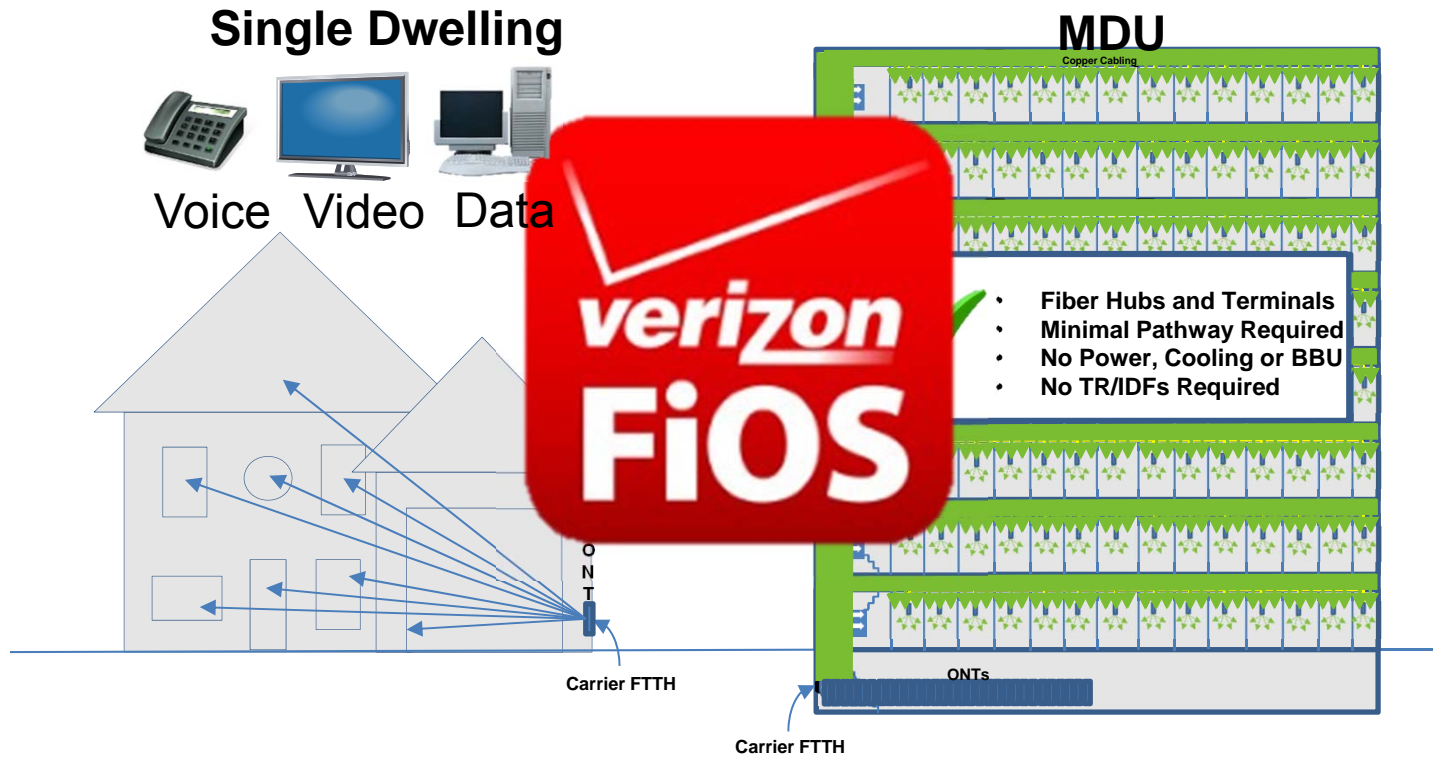

What's the difference between a...

30 Story Apartment Building and a 30 Story Office Building



Furniture!



Target POL users



Healthcare

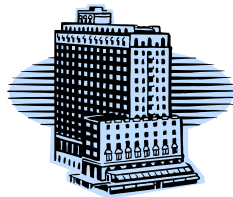

Hospitality



Education
(K-12 and Higher Ed.)



Campuses



High Occupancy Buildings
(Call Centers)

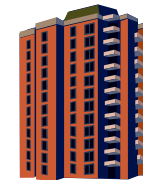

Multi-Tenant Units
(Commercial and Residential)



Casinos



Government and Military



Sporting Venues



Market Segment Adoption (Partial List)

Government and Military

- Department of Energy
- Department of Defense
- Department Homeland Security
- Health & Human Services
- Intelligence Agencies
- NASA
- State Department
- US Air Force
- US Air Guard
- US Army
- US Army Reserves
- USDA Forest Service
- US Marine Corps
- US Forest Service

Hospitality/Hotels/Resorts

- Marriott
- Mandarin
- Crown Plaza
- Buccament Bay Resort
- Ice Hotels
- Kittitian Hill Resort

Business Services

- Canon
- Google International HQ Sunnyvale
- Getty Images London HQ
- Verizon Business Offices
- GlaxoSmithKline
- Shearman & Sterling
- NiSource
- Center for Excellence in Wireless & IT
- Advanced Energy Center
- Simmons Building for Physics & Geometry
- Motorola Solutions Sweden AB
- Deltek
- Miles & Stockbridge Law firm
- Telecommunications Industry Association

MTU/MDU Residential and Commercial

- Empire State Building
- Dallas Fort Worth Airport
- Trump Tower Miami
- Trump Plaza NY
- Stuyvesant Town/Peter Cooper Village NY

Financial

- Russell Investments (AU)
- SouthEast Bank

Healthcare/Hospitals

- Erickson Living Retirement
- Pardubice Regional Hospital
- ArchCare/Cardinal Cooke Center
- Williamsburg Landing
- Camp Pendleton Hospital
- Western State Hospital
- Guthrie Corning NY Hospital

Education/K-12/Universities/Colleges

- Virginia Tech
- Howard Community College
- Stony Brook State University
- University of Mary Washington
- Bridgepoint Education
- Dalhousie University
- Amherst College
- Chilliwack School District (BC)
- Washington State University
- American College of Radiology
- Orangeburg Public Schools
- San Diego Public Library
- Santa Fe Public Schools



Example POL Implementation

Global Fortune® 225 Company – Americas Headquarters Melville, NY USA

Project Overview:

- Approximately 1 million sq. ft. (main building and 2 parking garages)
 - Planned growth for another 200,000 sq. ft.
- 1,500 employees
 - Planned growth for another 750
- Nearly 12,000 GPON Ethernet ports

Integrated Technologies over GPON:

- VoIP (PCs tethered through phone)
- Security
 - Access Control
 - Biometrics
 - Cameras (main building and parking)
 - Virtual turnstiles
 - Blue Phones in parking garage
- 480 WAPs
- Building automation
- Environmental controls
- IP Video content distribution
- Digital signage
- Point of Sale



Member Integration/Implementation

Project Highlights

\$1 million in CAPEX savings

Approximately \$250,000/yr in energy savings



San Diego Downtown Central Library

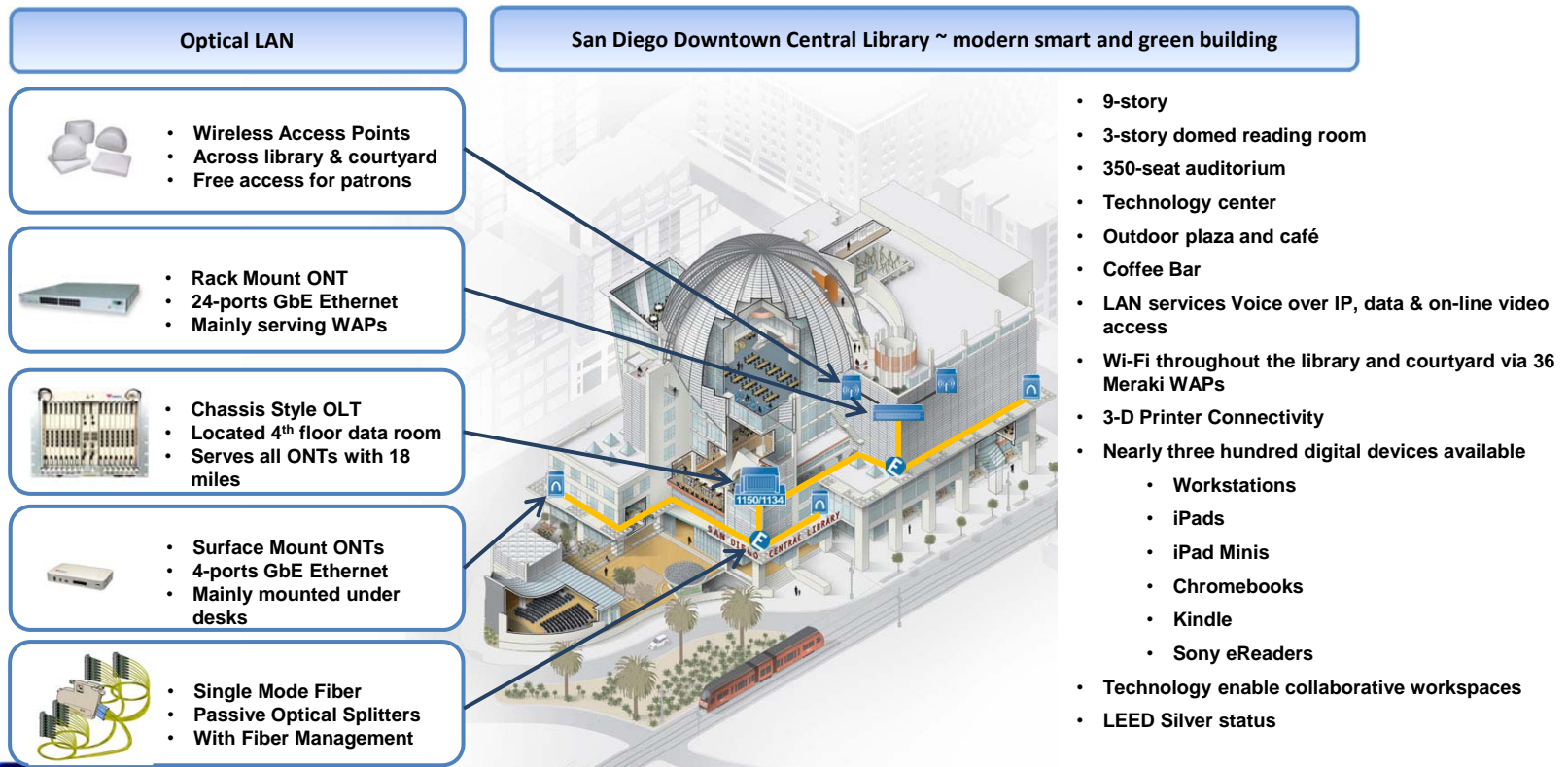

Knowledge Check



Passive Optical LAN is a standards based/recognized technology

- ✓ A.True
- B.False



Guaranteed bandwidth is possible with...

- ✓ **A. Passive Optical LAN**
- B. Switch Based**
- C. Both A and B**



POL supports 802.1Q VLANs

- ✓ A.True
- B.False



**AES 128 Encryption is present in _____
direction(s)**

A.The upstream

✓ B.The downstream

**C.Both upstream and
downstream**



Section 2 Agenda

- Verticals
- Bandwidth Requirements
- Dynamic Bandwidth Allocation
- Knowledge Check



Education Vertical

- **K-12**
 - Tight budgets vs. increased demand
 - Space constraints and non-traditional TRs/IDFs
 - Aging architecture vs. modern technology
 - Mondo Pads
 - AMX SchoolView
 - Smart Boards
 - Central content

- **Post Secondary / Higher Education**
 - Higher bandwidth demand
 - Increased BYOD
 - Valuable space lost with traditional
 - Lost revenue and added costs
 - Inefficient use of bandwidth
 - Inefficient use of space
 - Service providers profit



Hospitality Vertical

- **Hotels**
 - Industry groups driving POL advanced technology
 - HTNG – Hotel Technology Next Generation
 - HFTP – Hospitality Financial & Technology Professionals
 - HITEC – Hospitality Industry Technology Exposition and Conference
 - Higher port density in guest rooms and non administrative areas
 - Digital signage
 - Cameras
 - WAPs
 - IP card readers and locks
 - Four to eight data ports per guest room
 - Scalable solution with extended reach
 - Resort properties
 - Shared plot properties (Fairfield Inn, Courtyard, and Residence Inn)
 - Future proof cabling infrastructure



Healthcare Vertical

- **Assisted Living**
 - Patient wandering – WAP monitoring
 - In residence
 - Anywhere on the property
 - VoIP and Data needs in residence and administration
 - Security and Digital Communication

- **Critical Care**
 - Higher bandwidth demand
 - Higher port counts in patient rooms, nurse stations, and operating rooms
 - Building Automation and Intelligent Structures (converged networks)
 - Security
 - Monitoring
 - HVAC
 - Automated check-in / check out
 - Door sensors
 - No EMI/RFI concerns or Tempest shielding needed with fiber
 - Encrypted data pathways



Large Enterprise / Financial Verticals

- **Large Office Building**
 - Movement toward all BYOD
 - Converged networks (HVAC, Automation, Security, etc.)
 - Pathway and space constraints
 - Cost of traditional switch, cabling, and maintenance refresh
 - Increased technology
 - Pervasive wireless
 - Digital signage
 - Everything headed IP

- **Financial (Banks and Trading Floors)**
 - Higher bandwidth demand
 - Increased security
 - Increased port count
 - Redundancy, diversity, and automatic failover (FSAN-B)
 - Lost revenue and additional costs
 - Downtime (three 9s vs. five 9s)
 - Missed trades
 - Excess energy



Call Centers, Cities, and Retail

- **Call Centers**
 - High density areas
 - Low bandwidth requirements
 - IP Phones ~ 95Kb/s
 - Virtual “Dumb” terminals ~ 1Mb/s
 - Print/Scan/Fax ~ 500Kb/s

- **Cities, Towns, Neighborhoods, and MDUs**
 - Connect multiple buildings without distance limitations
 - Older buildings do not have pathways and spaces for traditional upgrades
 - Scalable solution for future expansion

- **Retail**
 - Digital signage
 - Customer Interactive Experience (pricing, web details, ordering, price compare)
 - Security, POS, multi-tenant service



You need how many “Gigs”?

Common LAN Services	Typical Required Bandwidth
Email and Web Browsing	500Kbps
Voice over IP	110Kbps
Cloud-based Services (data storage, enterprise s/w, collaboration, etc...) Low	50Kbps
Cloud-based Services (data storage, enterprise s/w, collaboration, etc...) High	100Kbps
Wireless Access Point Capacity (IEEE 802.11 a/b/g/n)	24Mbps
Wireless Access Point High Capacity (IEEE 802.11 ac/ad, dual radio)	300Mbps
IP Video Surveillance Standard Definition (MPEG4/H.264)	2Mbps
IP Video Surveillance High Definition (MPEG4/H.264)	6Mbps
IP Video Conferencing / Telepresence (720p-Good, includes primary/auxiliary)	2Mbps
IP Video Conferencing / Telepresence (1080p-Best, includes primary/auxiliary)	15Mbps

Gartner 2013 Estimates of Bandwidth needs through 2017 shows Super Users with a maximum requirement of sub-7Mbps



How much bandwidth is really needed?

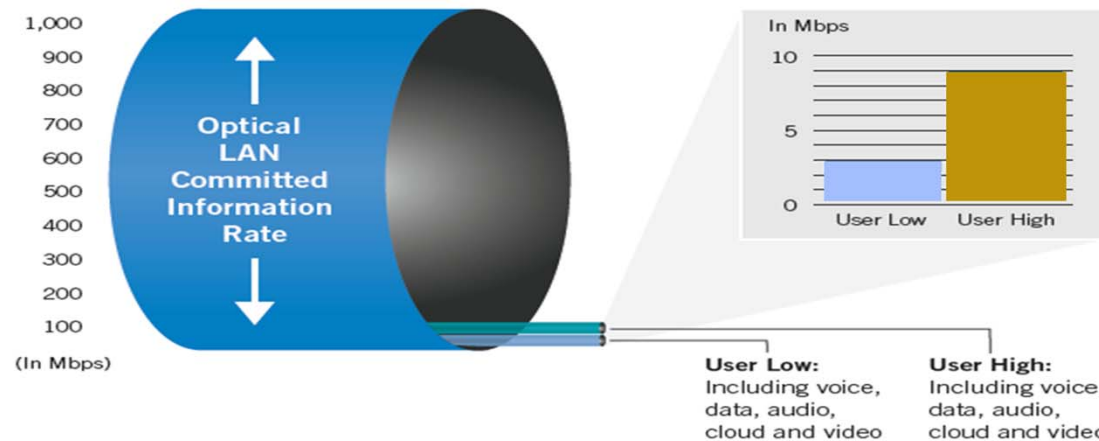

Optical LAN bandwidth compared to Peak bandwidth per User in 2017

- Blue represents symmetrical 1 gigabit bandwidth available at every ONT port
- Light Blue and Green represents Gartner Low User and High User bandwidth required 2017

Bandwidth Capacity vs. Bandwidth Traffic



In traditional networks...



Listen up!!! I have 10Gig OM4 Fiber in my Backbone and 10Gig Cat6 Copper in my Horizontal, so when I put in a 10Gig switch it won't have any resistance and I will get a Gig to the desk and be future proof.



Backbone OM3/4 (10Gb/s)



Horizontal CAT6A Cu (10Gb/s)



It is not a matter of resistance...

48 Port Gigabit Ethernet Switch

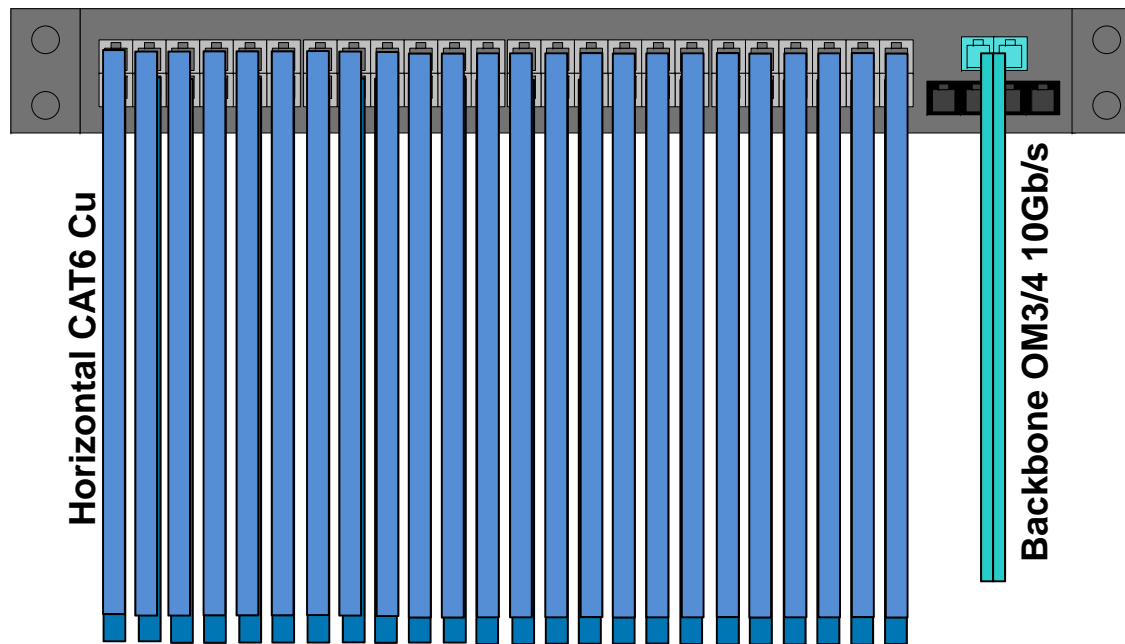

208 Mb/s



Does your IP phone need 208Mb/s?

Switch Data vs. Dynamic Bandwidth Allocation

24 Port 10/100 Ethernet Switch

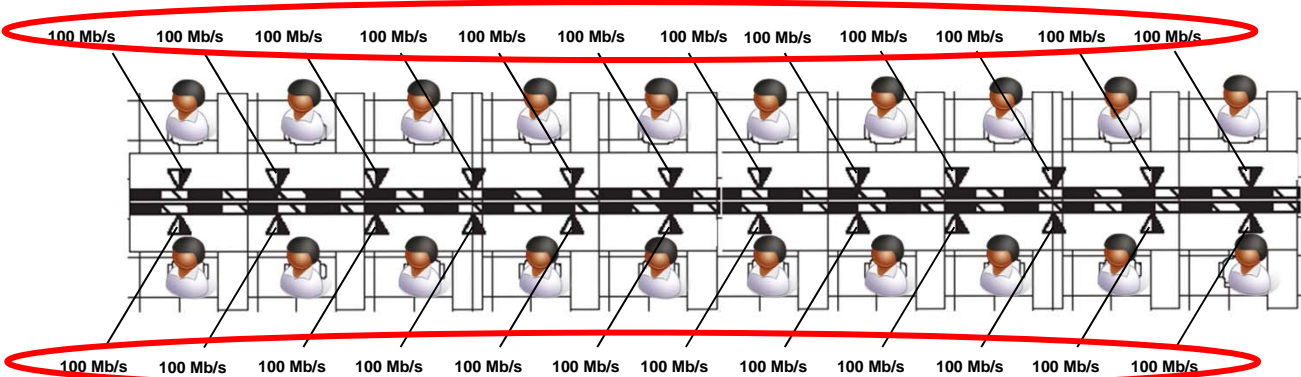

Most users use 0Mb/s over 98% of the workday
 When all users are using 100Mb/s, people are leaving and a single user
 has to very hard because it has a 100Mb/s connection
 Every data port has a minimum of 100Mb/s

- A minimum of 100Mb/s
- A maximum of 100Mb/s
- A maximum of 100Mb/s



Switch Data vs. Dynamic Bandwidth Allocation

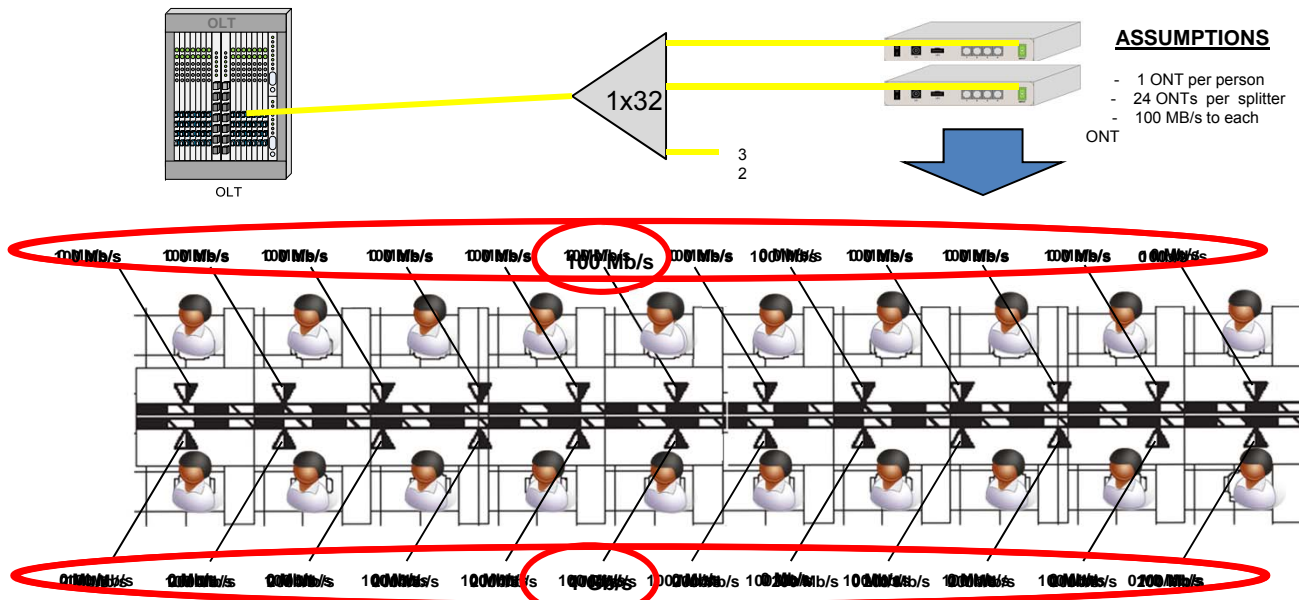

ASSUMPTIONS

- 1 ONT per person
- 24 ONTs per splitter
- 100 MB/s to each ONT

Most users use 100Mb/s over 98% of the workday. When a user starts a file transfer, the network requires a burst of 1 Gb/s. Every user has a committed rate of 100Mb/s. The committed rates from the network are shared and burst to 1 Gb/s.

- A minimum of 100Mb/s
- A maximum of 1 Gb/s



VLANS and Committed /Burst Rates

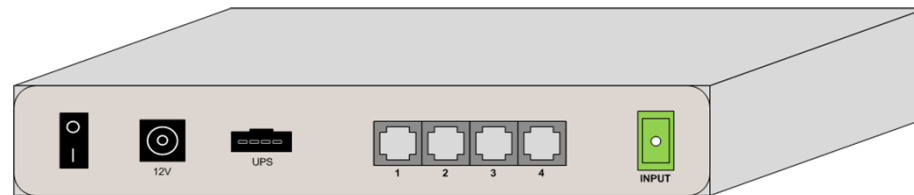

Knowledge Check



Gigabit switches provide 1Gb/s connections to each WAO

A.True

✓ B.False



Most users consume bandwidth all day long

A. True

✓ B. False



This technology uses Dynamic Bandwidth Allocation

A. Switch Based

✓ B. Passive Optical LAN



Most users require a sustained GbE connection

A. True

✓ B. False



Section 3 Agenda

- Layout
- Primary Components
- Design Tips
- Support and Compatibility
- Knowledge Check
- Lunch



Traditional LAN vs. POL (GPON)

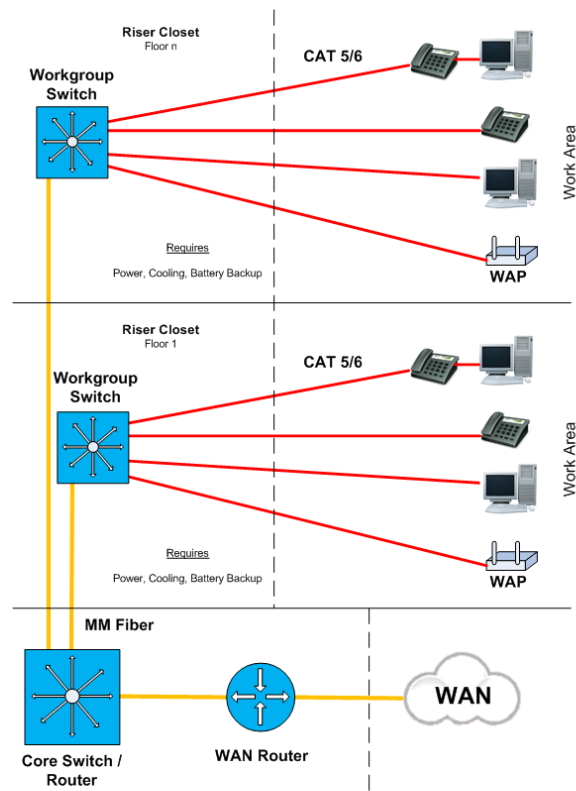

Traditional LAN

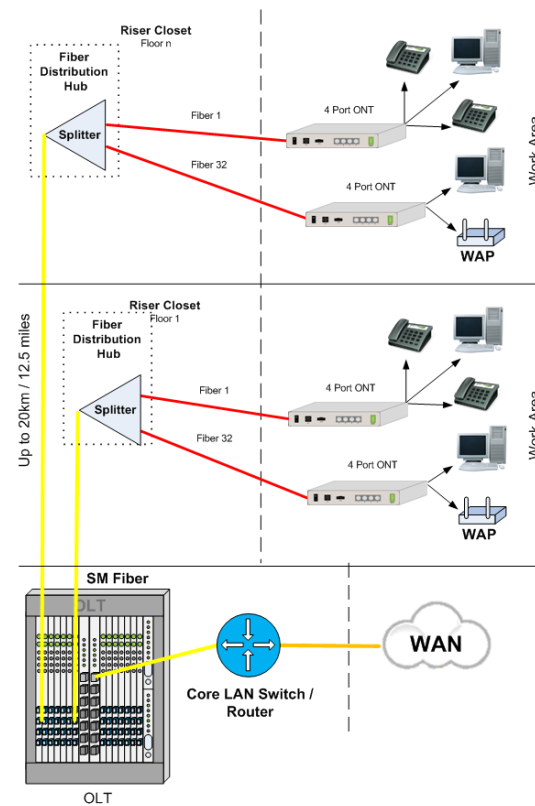

Passive Optical LAN



On a Campus

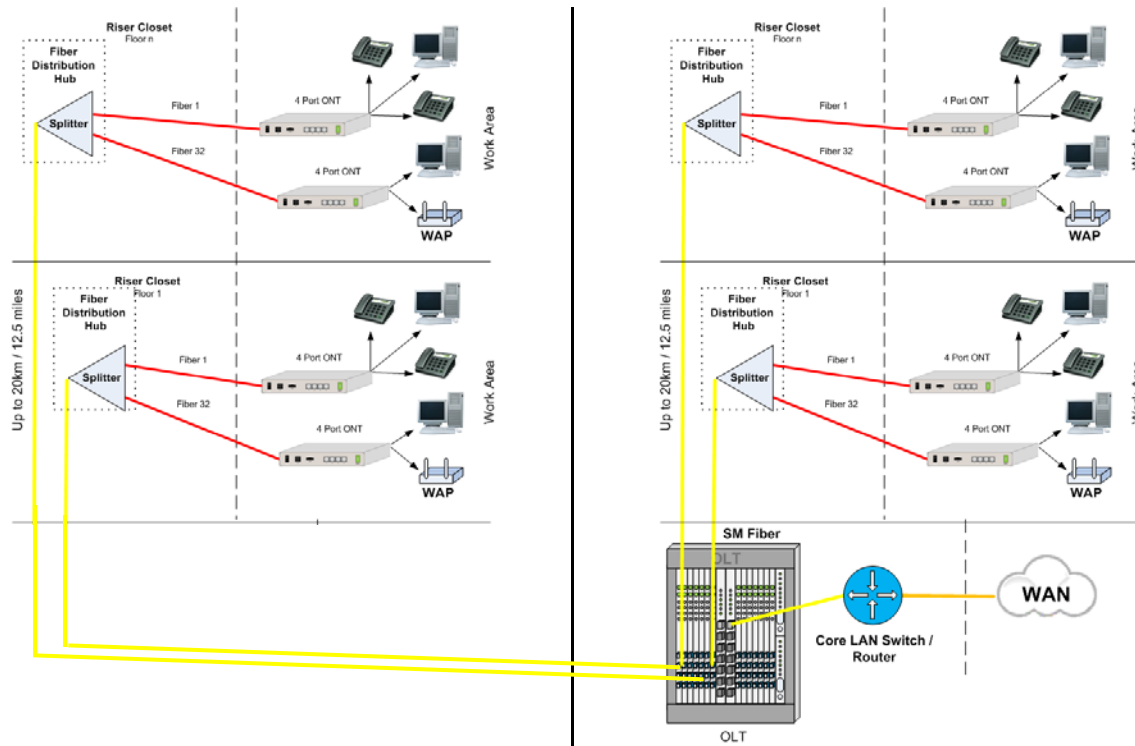

Optical LAN



Basic POL Schematic

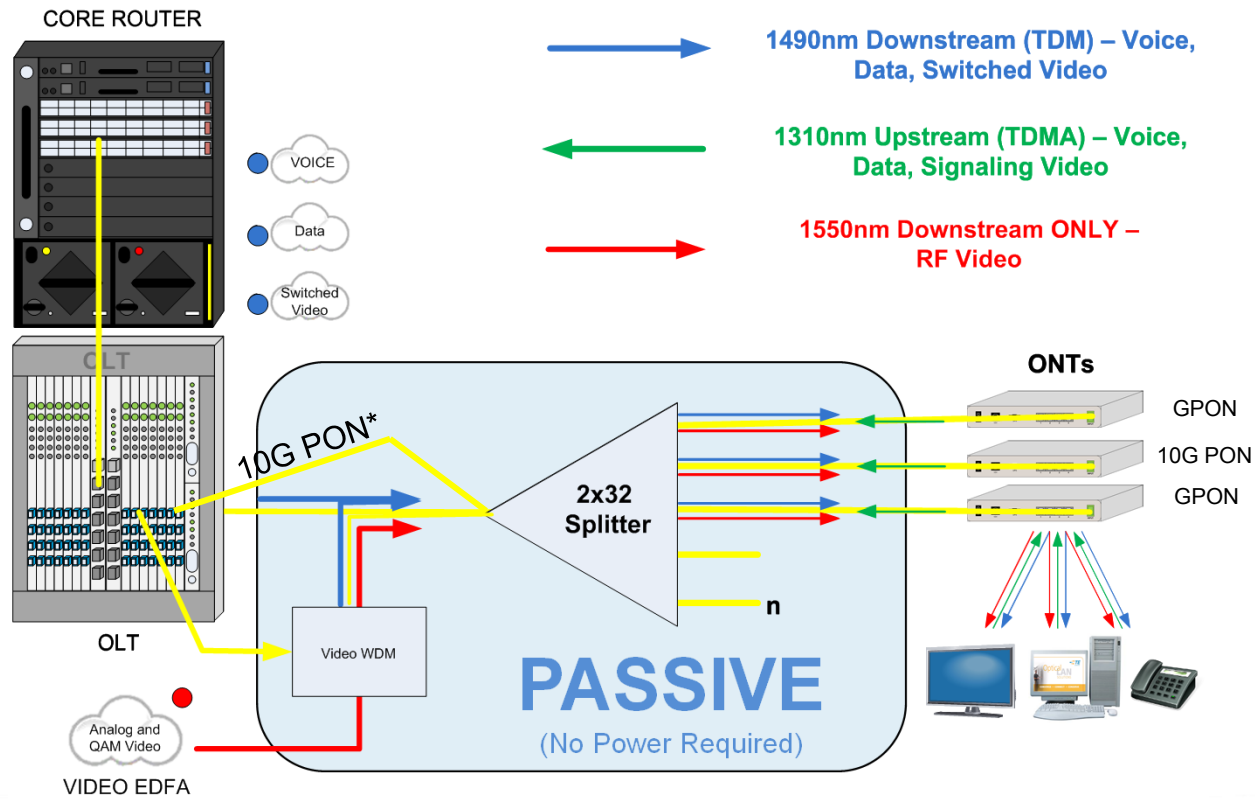

Only upgrade the users that need 10G PON

* Methods vary by electronics vendor

The Migration to 10G PON1

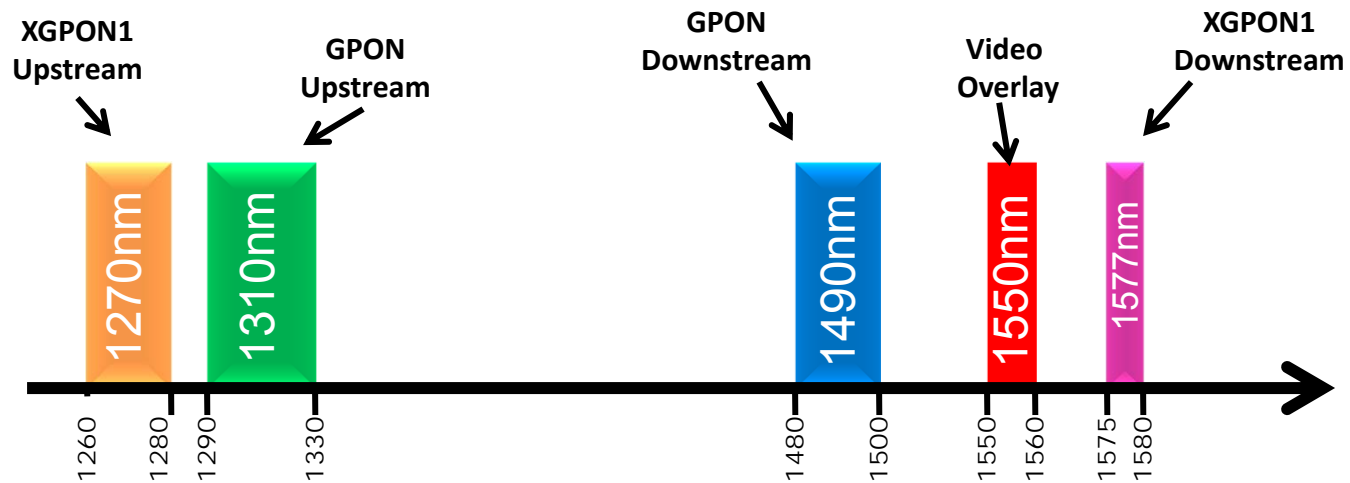

The cabling infrastructure stays the same and only the users that need it are upgraded.



The Primary Components

Optical Line Terminal (OLT)

- Active equipment provided by suppliers such as Tellabs and Zhone
- -48VDC Carrier Grade Chassis
- After Layer 3
- Up to 14 Line cards
- Typically 4 singlemode output ports per card
 - = 56 Outputs per chassis
 - = 1792 Work Group Terminals (1x32 splitters)
 - = 7168 Ethernet Ports (ONT has 4 copper output ports)

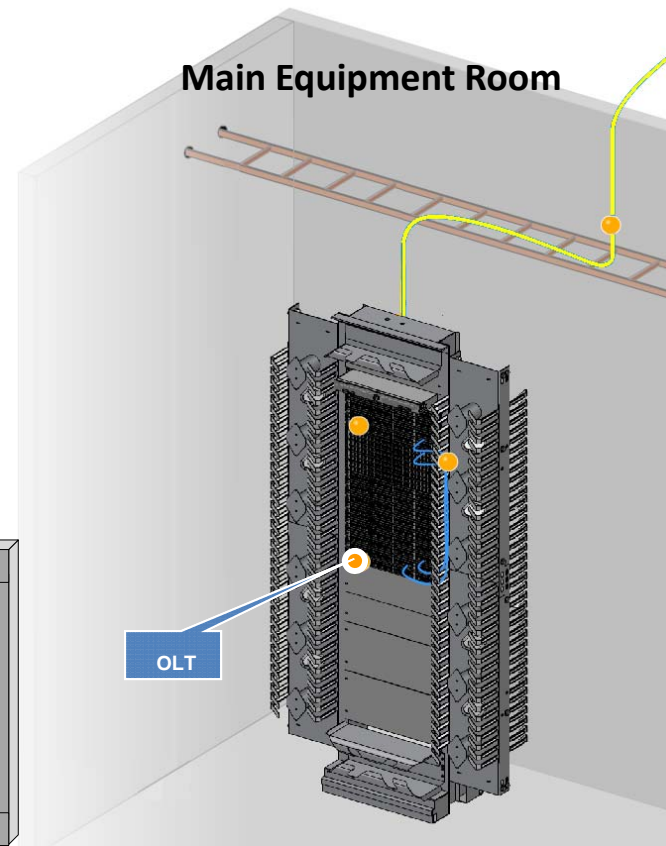
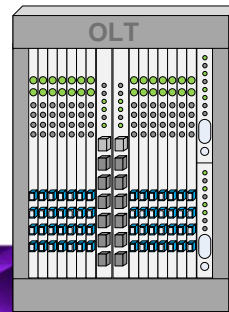

The Primary Components

Optical Splitters



Available Splits

1x2

1x4

2x4

1x8

2x8

1x16

2x16

1x32

2x32

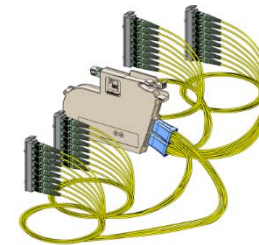

Traditional 1U Rack-Mount Splitter

Bicsi



Planar Light Circuit/Planar Waveguide

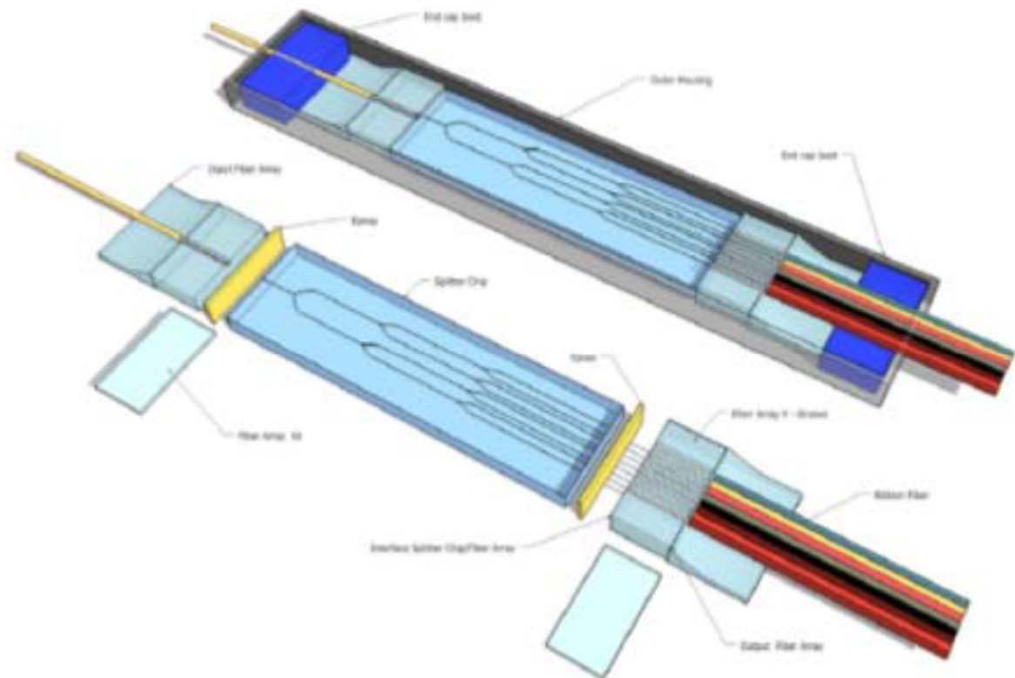

The Primary Components

ONT – Optical Network Terminal

- Active equipment provided by electronics manufacturers.
- Located near the user or device
- Typically 4 RJ45 (10/100/1000) outputs with optional POE
- Up to 60W of available POE (vendor specific)
- Standard HVAC is adequate
- Optional internal or external battery back-up
- POTS and COAX ports available
- Establishes and maintains secure AES 128 Encryption
- Supports multiple VLANs on each port

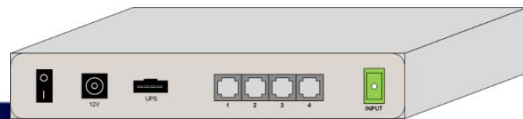
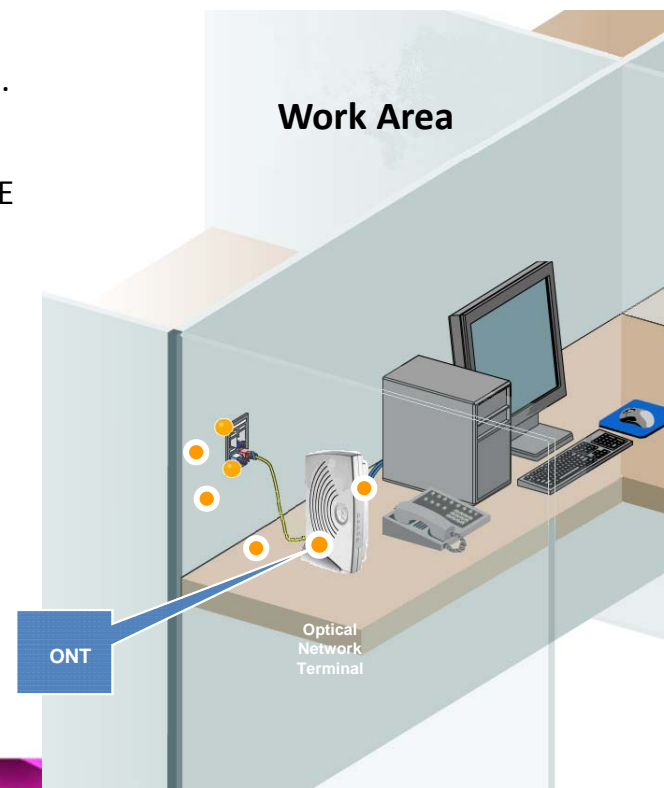

ONT

Bicsi

ONT Placement



Ceiling tile mount



Wall-mount



Under-desk mount



Desktop mount



SECURE Wall Box



SECURE Wall Box



Wall Plate ONT

Bicsi

ONT Sharing

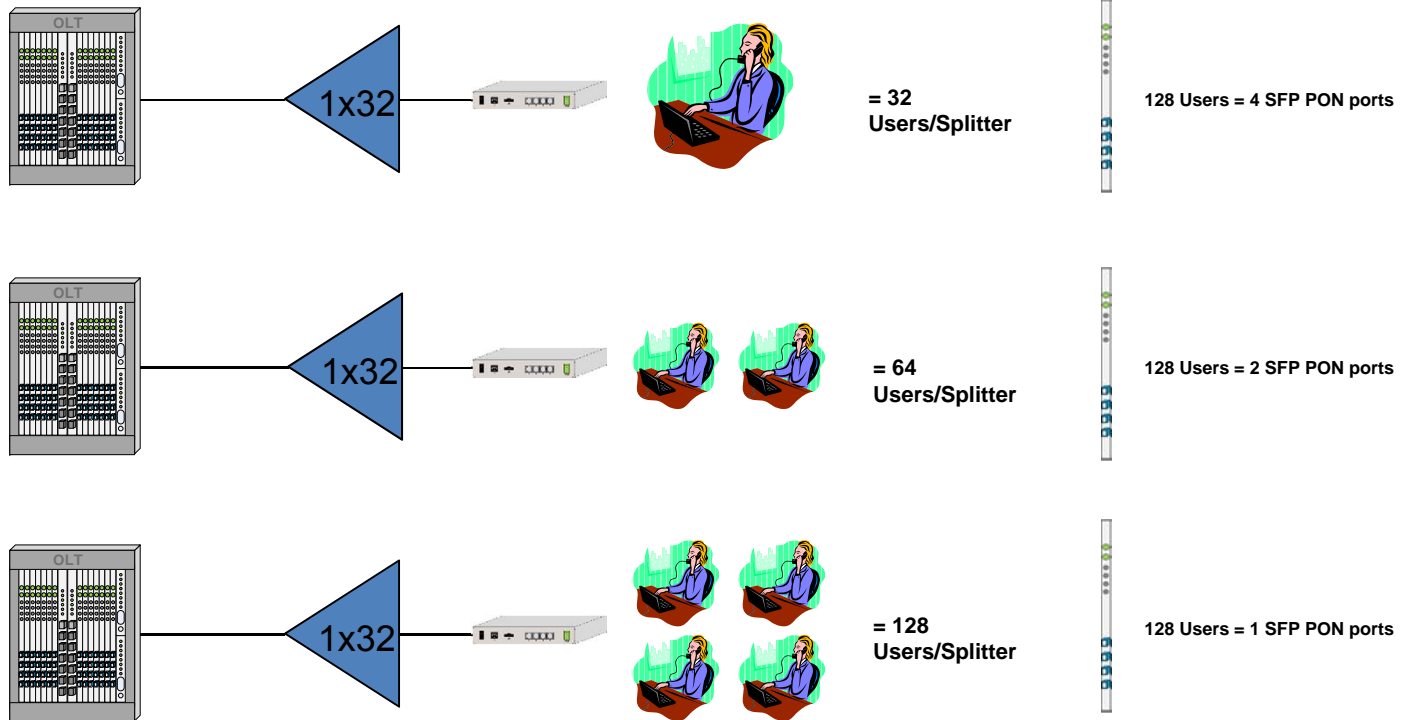

Distance and Loss

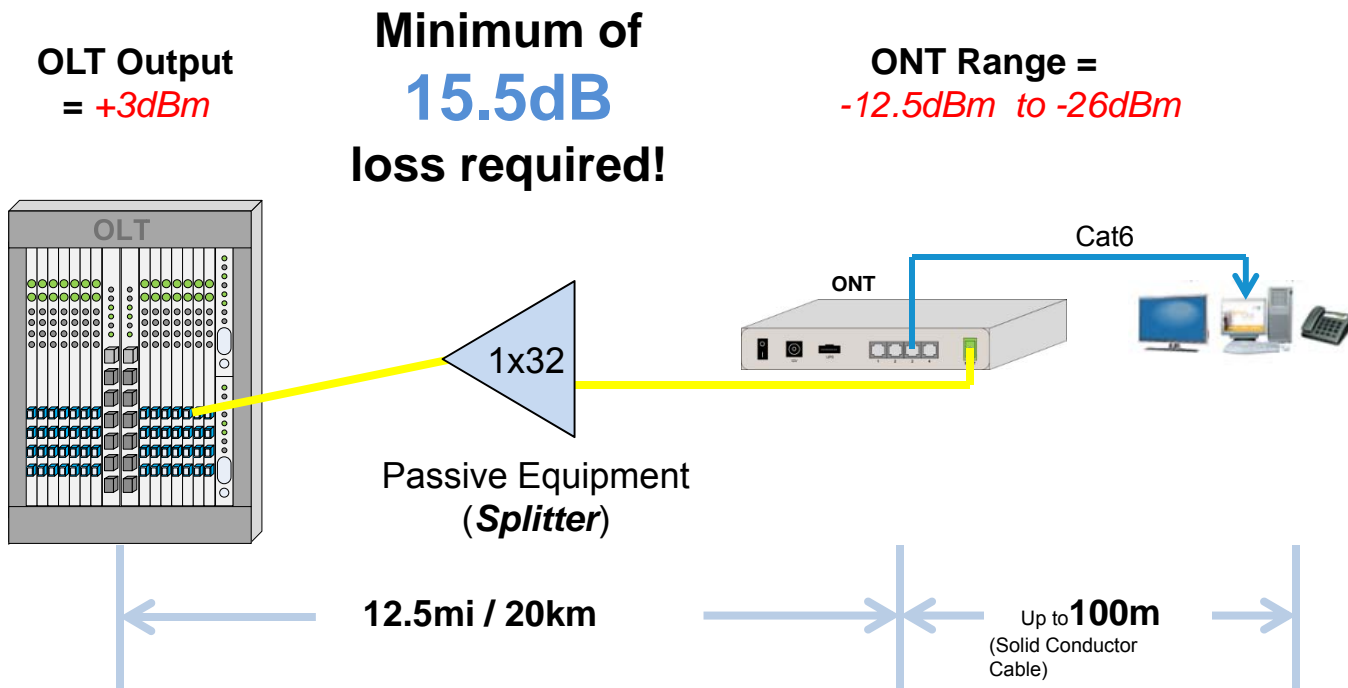

Splitter Loss

Splitter	Max Loss*	Typical Loss*	Wavelength Range
1x2	3.8dB	3.1dB	1260-1360nm and 1480 -1580nm**
2x2	4.3dB	3.2dB	1260 - 1635nm
1x4	7.2dB	6.6dB	1260 - 1635nm
2x4	7.8dB	6.7dB	1260 - 1635nm
1x8	10.3dB	9.7dB	1260 - 1635nm
2x8	10.9dB	9.8dB	1260 - 1635nm
1x16	13.5dB	12.8dB	1260 - 1635nm
2x16	14.1dB	12.9dB	1260 - 1635nm
1x32	16.7dB	16.0dB	1260 - 1635nm
2x32	17.4dB	16.2dB	1260 - 1635nm
1x64	20.4dB	19.7dB	1260 - 1635nm
1x2 + 1x16	17.3dB	15.9dB	1260 - 1635nm
1x4 + 1x8	17.5dB	16.3dB	1260 - 1635nm



* Includes PDL, WDL and TDL. Does not include connector loss

** May not be compatible with NG PON1 or NG PON2

Cascade Splitting Loss

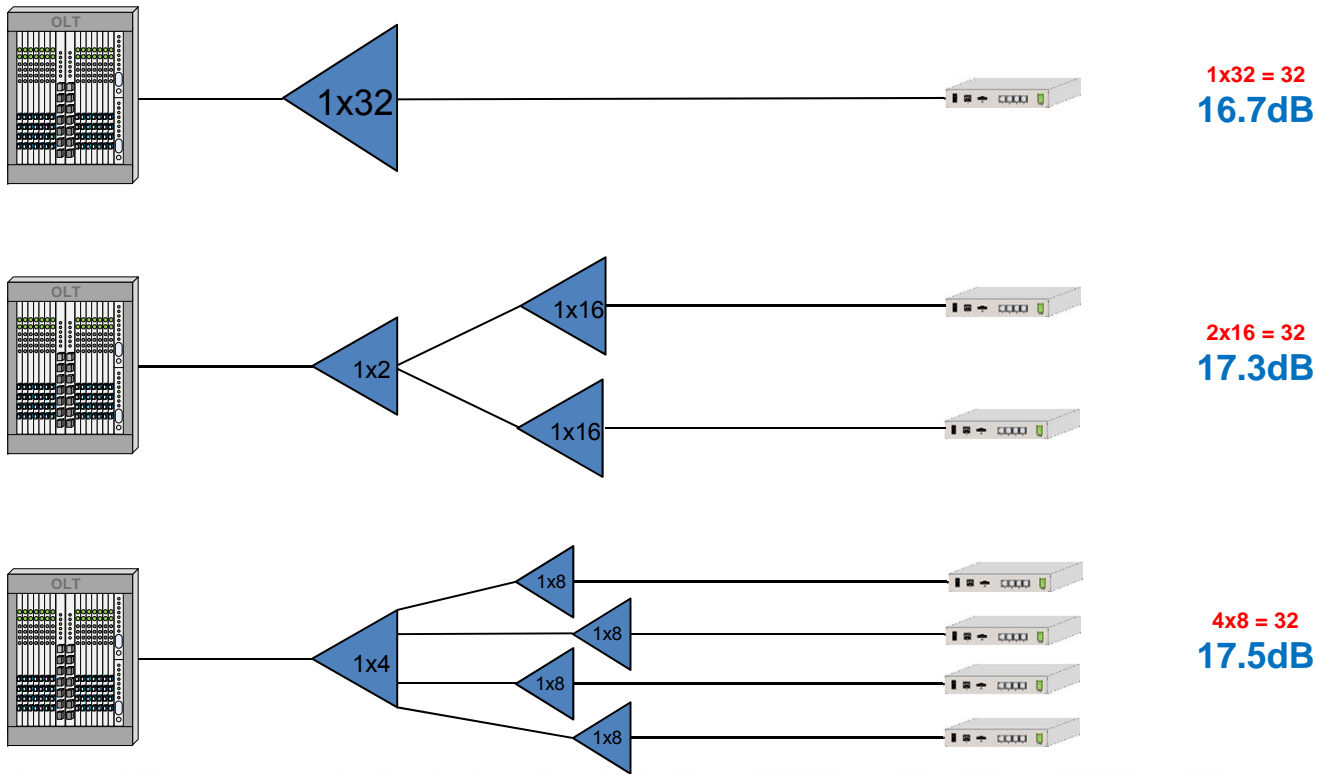

Split Ratios Do NOT “Change” Bandwidth

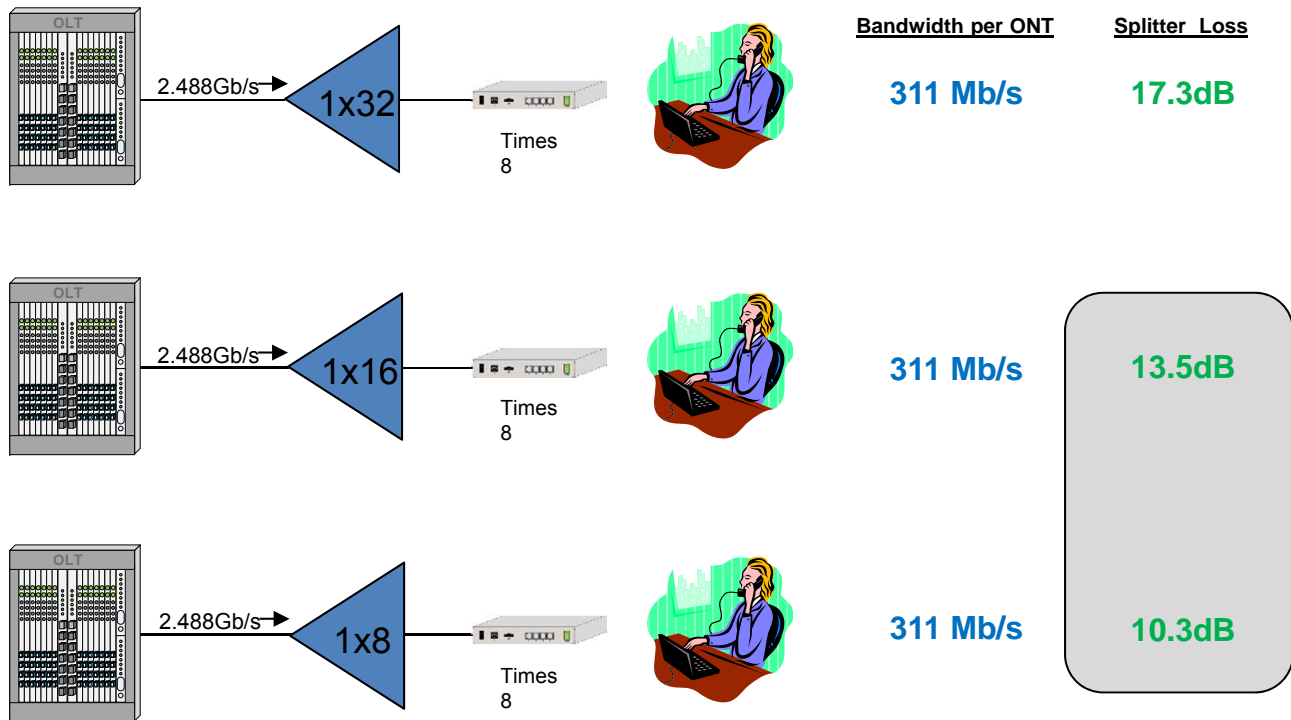

Each ONT may require an Attenuator

Type B (FSAN-B) Redundancy

If any interruption is detected on the primary path (OLT to ONT), the OLT will switch to the redundant path instantaneously.

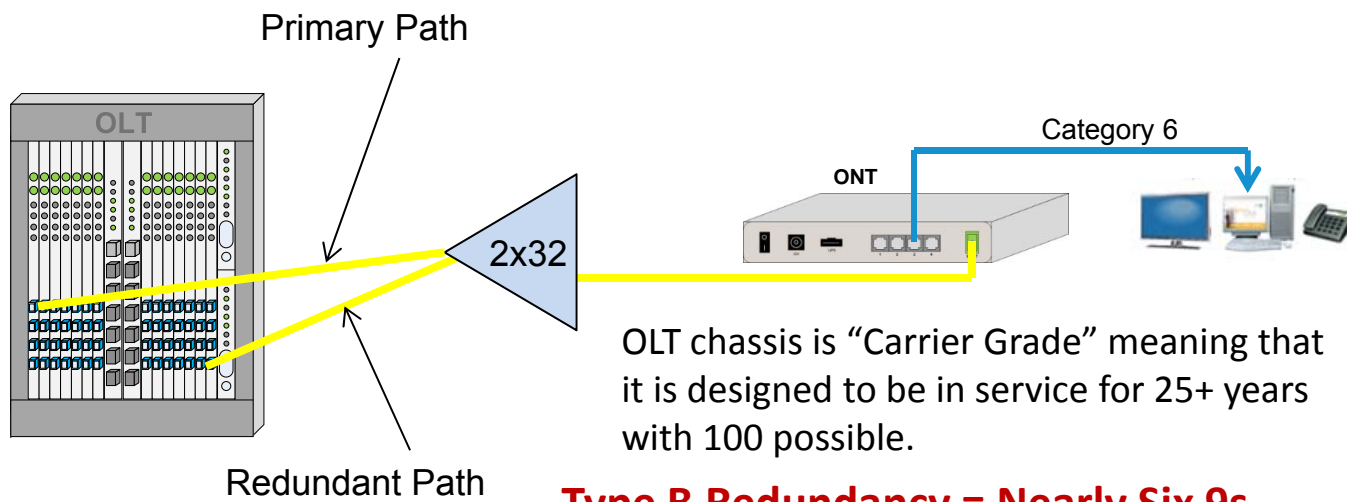

Type B Redundancy = Nearly Six 9s



Example Layout of Type B (FSAN-B) Redundancy

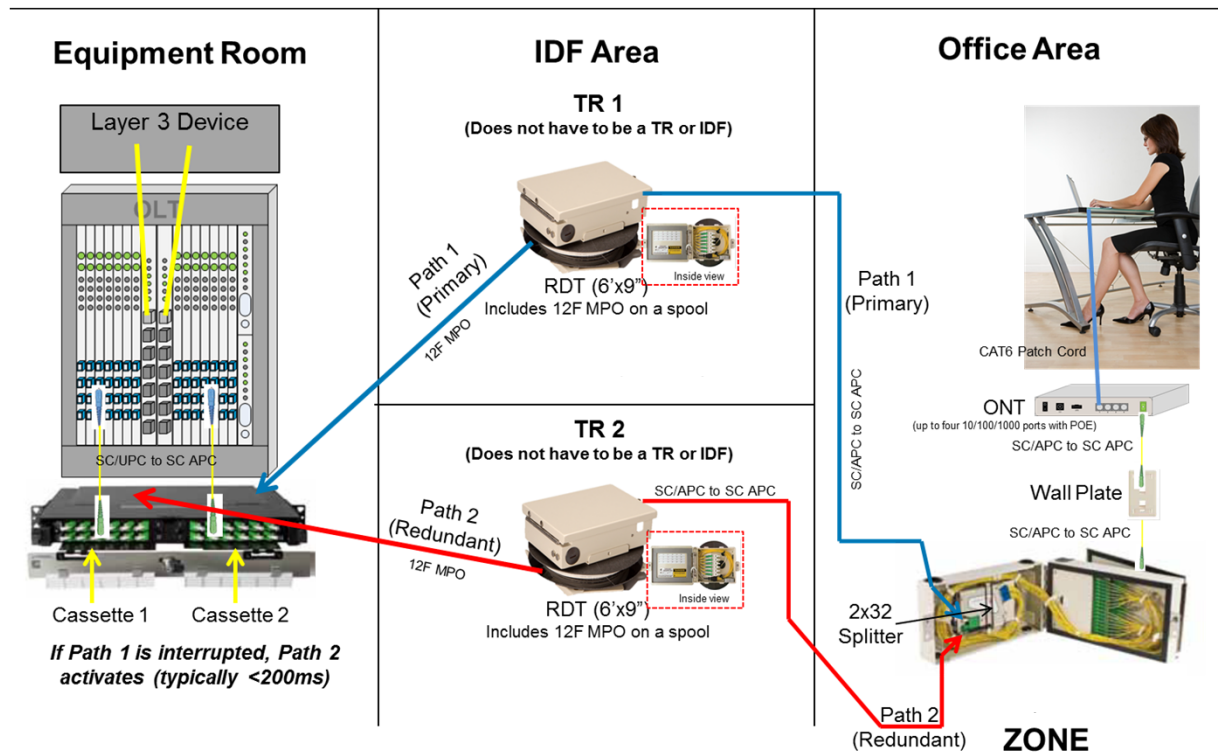

IP/Ethernet Protocol Support

Network Integration	Service Delivery	Monitoring / Management
Multiple 1G and 10G Ethernet Uplinks	802.1p: Class of Service	SNMP v1, v2, v3
IEEE 802.3ad Link Aggregation Control Protocol (LACP)	IP differentiated services code point (DSCP)	CLI Console Port
IEEE 802.1Q VLAN Encapsulation	Quality of Service: Per-VLAN, Per-Port, Per-Service queuing / scheduling *	Remote Monitoring (RMON) software agent
IEEE 802.1w Rapid Spanning Tree (RSTP)	Sophisticated QoS and Traffic Management	RMON I & II
IEEE 802.1s Multiple Spanning Tree (MSTP)	Eight Queues per VLAN	Enhanced SNMP MIB support
Virtual Router-to-Router Redundancy (VRRP)	Policing, Scheduling, Shaping per Queue	RFC 1213-MIB (MIB II)
IPv4 / IPv6	Congestion and Flow Control	Extended MIB support
IGMPv2 / IGMPv3	Hardware Based ACLs: L2, L3, L4	Network Timing Protocol (NTP)
Network Access Control (NAC)	Hardware Based Multicast Management	RADIUS based authentication
IEEE 802.1x (Port-based Authentication)	IEEE 802.3af, 802.3at (PoE)	SSH v1, v2
Dynamic Host Control Protocol (DHCP)	Link Layer Discovery Protocol (LLDP)	VMWare Support for EMS
DHCP Snooping and Option 82 insertion		OLT SysLog support (2014)
Port Security, Sticky MACs		Y.1371 (2014)
RFC-2267 (Denial of Service)		802.1ag Fault Detection (2014)
Traffic Storm Control		
Bridge Protocol Data Unit (BPDU) Guard		

This represents a partial list of supported IEEE and IP/Ethernet protocols



Knowledge Check



Upstream (ONT to OLT) analog video utilizes which wavelength?

A. 1550nm

B. 1490nm

C. 1310nm

D. 1625nm

✓ E. None



A cascaded 1x4 + 1x16 split is a good practice?

A.True

✓ B.False



GPON bandwidth can be increased by using a lower split ratio

A.True

✓ B.False



The minimum loss required between the OLT and ONT is...

- A. 13.5dB
- B. 10.7dB
- ✓ C. 15.5dB
- D. 17.2dB
- E. None of these



PoE in a POL is administered at the...

A.OLT

✓ B.ONT

C.Injector

D.PoE is not possible



60 Minute Lunch Break



Please respect others and return on time.

Bicsi



Section 4 Agenda

- Savings
- LEED and Environmental Benefits
- Largest POL deployment in the world
- Knowledge Check
- 15 Minute Break



Savings



Bicsi



POL: Total Cost of Ownership Savings

Expense	250 Users	500 Users	1000 Users	Campus 5000 Users	Campus 10,000 Users
TCO	32%	46%	57%	68%	68%
CapEx	31%	41%	48%	55%	55%
OpEx	40%	50%	65%	70%	70%
• Power	48%	61%	68%	75%	75%
• Cooling	48%	61%	68%	75%	75%



POL: Power Consumption Comparison

**Regional Medical Center
4000 drops**

Price per kw hour	\$0.082	W/HR	Annual \$
Total POL Budget		14,050	\$10,081
Total Traditional Budget		37,171	\$26,670
Difference		(23,121)	(\$16,589)
Total Savings Percentage		-62.20%	

Traditional LAN				
Main Distribution Frame				
Description	Quantity	Rated Power	Total Power	Notes
Cisco WS-C3750X-48P-S(715W)	7	134	937	
UPS	1	937	187	UPS overhead
HVAC	1	1,125	1,350	Draw to cool UPS & Cisco *1.2
Total			2,474	
Intermediate Distribution Frames				
Description	Quantity	Rated Power	Total Power	Notes
Cisco WS-C3750X-48P-S(715W)	96	134	12,854	
UPS	1	12,854	2,571	UPS overhead
HVAC	1	15,425	18,510	Draw to cool UPS & Cisco *1.2
Total			33,936	
Desktop/Work Area				
Description	Quantity	Rated Power	Total Power	Notes
N/A				
Total			0	
Power over Ethernet				
Description	Quantity	Attenuation	Total Power	Notes
Copper drops	1,463			
Average length of drop	200			
Total feet	292,600	0.0026	761	Total loss via PoE
Total			761	

Passive Optical LAN				
Main Distribution Frame				
Description	Quantity	Rated Power	Total Power	Notes
AXS1800	2	516	1,032	2-SW, 2-SYS, 8-PON
UPS	1	1,032	206	UPS overhead
HVAC	1	1,238	1,486	Draw to cool UPS & AXS *1.2
Total			2,724	
Intermediate Distribution Frames				
Description	Quantity	Rated Power	Total Power	Notes
N/A	N/A	N/A	N/A	
Total			0	
Desktop/Work Area				
Description	Quantity	Rated Power	Total Power	Notes
WT21004		1,255	9	Admin areas
Total			11,295	
Power over Ethernet				
Description	Quantity	Attenuation	Total Power	Notes
Copper drops	1,463			
Average length of drop	8			
Total feet	11,704	0.0026	30	Total loss via PoE
Total			30	



Potential* LEED Credits

- Energy and Atmosphere Credit 1 (1-3 pts).
 - Reduction in TRs, HVAC equipment, switch equipment, UPS, lighting and other energy needs.
 - The PON system helps the overall efficiency of the energy systems.
- Innovation in Design Credit 1 (1-4 pts).
 - The PON system utilizes less equipment, resulting in less raw materials, less garbage, less transportation and reduced time for implementation and commissioning.
 - In addition, utilizing a fiber system ensures the life of the system extends beyond the life of a conventional “switched” system.



Bicsi

*not guaranteed or implied

“Eco-Friendly”

- **Reduced Power Requirements**
 - Savings between 40% to 60%
- **Reduced HVAC Requirement**
 - A Fortune 500 company saved about \$450K on the Power distribution network (HVAC, backup etc) for a building project with 2000 Ethernet ports
- **Reduction in Non-renewable materials**
 - Reduction of up to 8000 pounds of plastic and copper versus a Cat 6 install for building of 4000 Ethernet ports
- **Floor Space Savings**
 - Traditional layer-2 solutions are bound by the 300ft Ethernet limitation
- **Fire Load Savings**
 - Savings in Sprinkler Systems
 - Fire Load and ceiling space savings



Green Benefits

- Reduction in power consumption
- Reduction in non-renewable materials
- Ceiling space and fire load savings
- Reduction in cabling costs
- Floor space savings



Cabling Comparison

Riser Rated Cables	Reduced Bend Radius Single-Mode	Category 5e UTP	Category 6a UTP
10G Distance	40km	45m	100m
Cable OD	3mm	5.7mm	7.5mm
Weight	4lb / 1000'	22lb / 1000'	39lb / 1000'
Minimum Bend Radius	5mm	22.8mm	30mm
Tensile Strength	48lbf	25lbf	25lbf
Cost	Low	Medium	High

Bicsi



Largest Enterprise POL Deployment

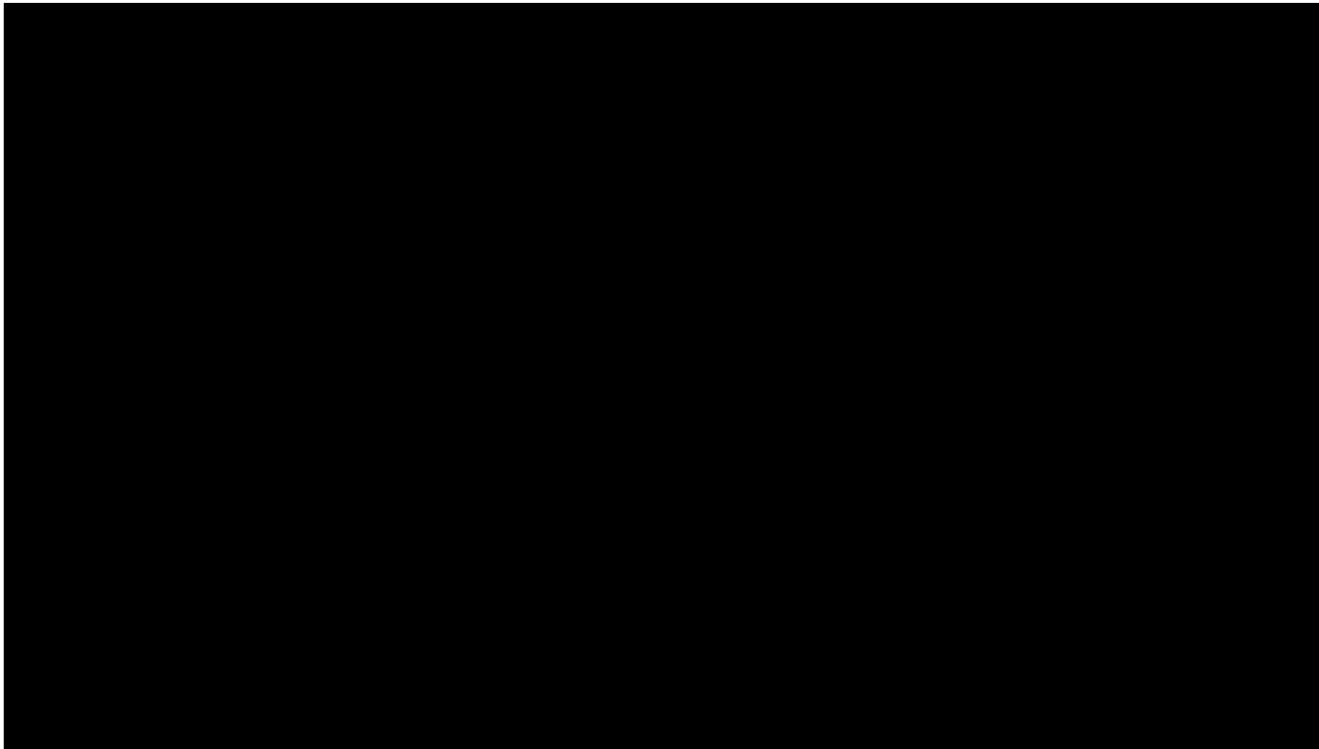

Bicsi



Knowledge Check



Which of these are a benefit of POL?

- A. Reduction in power
- B. Reduction of fire load
- C. Reduction of non-renewable materials
- ✓ D. All of these are benefits



LEED Credits are

- ✓ A. Possible with POL
- B. Automatic with POL
- C. Guaranteed with POL
- D. Not Possible with POL



So far, my knowledge depth of Passive Optical LAN increased so far today by...

A. A little

B. A lot

C. What is Passive Optical LAN?

D. None



Questions?

Passive Optical LAN: 101

Sean P. Kelly, RCDD

Bicsi



15 Minute Break



Please respect others and return on time.

Bicsi



Introduction to POL Components

Matt Miller

Sr. Solutions Architect, CallisonRTKL



Bicsi



Agenda

- Components
 - OLT
 - ONT
 - Video
 - DC Power
- Power Considerations
- Management
 - Centralized Management
 - Management Systems
 - Bandwidth Management
 - VLANs, QoS, LLDP and other Standards



Objectives

- Identify the various types of optical splitters and their principles of operation
- Identify the active electronic components in a Passive Optical LAN
- Understand the management principles for a POL



Components - OLT

- OLT is head-end component
- Typically located in MDF or Data Center
- Manages connected ONTs
- Typically consist of:
 - Management
 - Switch Fabric
 - Uplink Interfaces
 - PON Interfaces
- Out-of-band Management



Components – Large OLT Models

- Chassis-Based
- Fully Redundant
- Up to 224 PON Ports
- Thousands of ONTs
- DC Powered



Components – Small OLT Models

Small OLTs

- AC and DC Power
- Small Chassis and Standalone
- Small Office/Field Office
- 4 to 16 PON Ports
- Hundreds of ONTs



Bicsi



Components – OLT Uplinks

- Standard Ethernet uplinks to core
- Uplinks typically 1G or 10G pluggable optics
- VLANs trunked into uplink ports
- Uplinks can be combined into LAGs



Components – OLT PON Ports

- From 4 to 224 PON ports per OLT
- Each PON port typically supports 32 ONTs
= Thousands of ONTs per OLT!
- Typically SFP based
- Class C+ optics feature 32dB loss budget



Components – OLT Redundancy

Typically Redundant

- Power
- Backplane
- Management
- Switch fabric
- Uplinks

Sometimes Redundant

- PON Ports
- PON Cards
- Entire OLT



Optical Splitters

- Splitters provide optical connections in pairs
- Each 1x2 split equates to $\frac{1}{2}$ of the optical power
 - ~3dB loss
- Splitters range from 1x2 up to 1x64 splitters
- 1x32 is the most common split ratio for POL

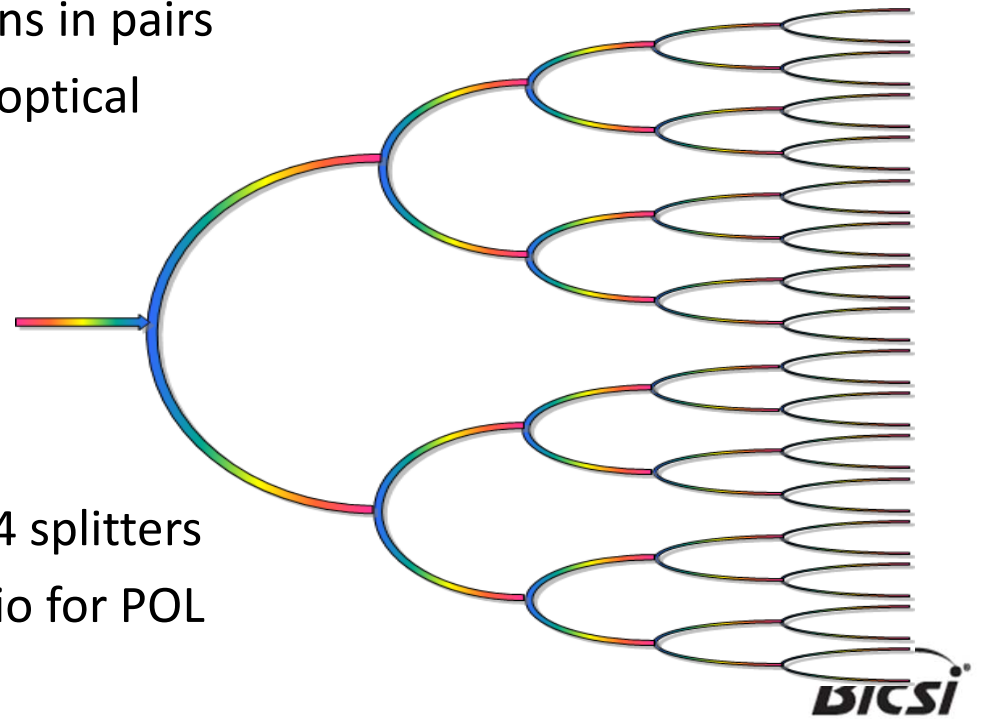

Optical Splitter

The term "passive" in Passive Optical Network refers to the fact that the splitter requires no power as opposed to an "active" device like the OLT or switches in a traditional network. The splitter serves to optically replicate upstream signals to a number of downstream fibers. The typical number of fibers served in a PON network is 32. As the splitter provides a replicated optical signal to all 32 subscribers downstream, it is simultaneously combining those 32 fibers into a single feeder fiber in the upstream direction. Consequently the optical splitter is sometimes referred to as a splitter/combiner. The splitter will be housed in a number of form factors.



Bicsi



PLC Splitter

Planar Lightwave Circuit (PLC) Splitter

- More Expensive
- Uniform Output
- Most appropriate for outdoor use
- Manufacturing
 1. Waveguide used to split the optical signal is fabricated using a silicon dioxide chip.
 2. Involves a lithographic process similar to that used in the manufacture of silicon computer chips. PLC splitters provide the most uniformity between fiber outputs (the downstream fibers) with respect to the amount of optical loss measured on each fiber.
- Best choice when loss is critical



FBT Splitter

Fused Biconical Taper (FBT) splitter

- Lower Cost
- Typically less uniform from fiber to fiber.
- Manufacturing
 1. Thermally fused two overlapping fibers together under tension
 2. The resulting fusion splice creates a two by two splitter.
 3. Typically, one of these fiber connections is trimmed off and the result is a single fiber subtending to two fibers.
 4. These two fiber outputs can then be fused to additional one-by-two splitters until the desired number of splits is achieved.
- Used where extreme temperature variations or other environmental factors are not likely to cause the optics connected at the ends of the fiber to drift from their optimum wavelength specifications.



2xN Splitters

- 2 Inputs
- 2 to 64 Outputs
- Second Input Allows
 - Redundant feeders/PON Ports/PON Cards/OLTs
 - Easier Migration to 10G
 - Flexibility for the Future



ONTs

- ONT located close to the end user
- Fiber input
- Variety of user interfaces available
- Provide PoE
- Consume ~7W power + PoE draw



ONT Models - Traditional

- Large variety of ONTs available
- AC and DC power options
- Desk-mount, In-wall, and Rack-mount
- Battery backup
- Match interfaces to user needs:
 - Ethernet Ports with PoE
 - POTS Ports
 - Coaxial Television
 - Wi-Fi



Bicsi



ONT Models - Unique

In-Wall

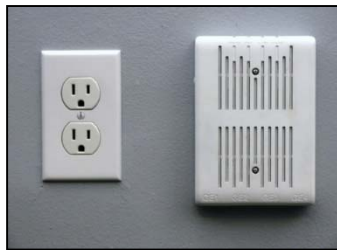

Rack-Mount



Industrial/Outdoor



Bicsi



ONT Connections

What Can I Connect?

- PCs
- Thin Clients
- VoIP Phones
- POTS Phones
- Wireless Access Points
- Coaxial Cable TV
- IPTV
- Access Control
- Security Cameras
- Building Management Systems
- Biometric Sensors
- Anything with an Ethernet, POTS, or Coax Interface!



ONT Compatibility

- EPON and GPON are not compatible
- Different manufactures *typically* choose not interoperate
- Beyond the standards, some manufacturers implement additional features – especially true in EPON



ONT Security

- ONT security designed to assume the ONT is in the hands of the adversary
- ONT does not function without OLT
- Usually no management ports on ONT
- ONT receives all programming from OLT



Power Considerations

- ONTs report a loss of power or loss of service
- ONTs can be powered via AC or DC
- Battery backups for high availability
- PoE and PoE+ available



Components - Video

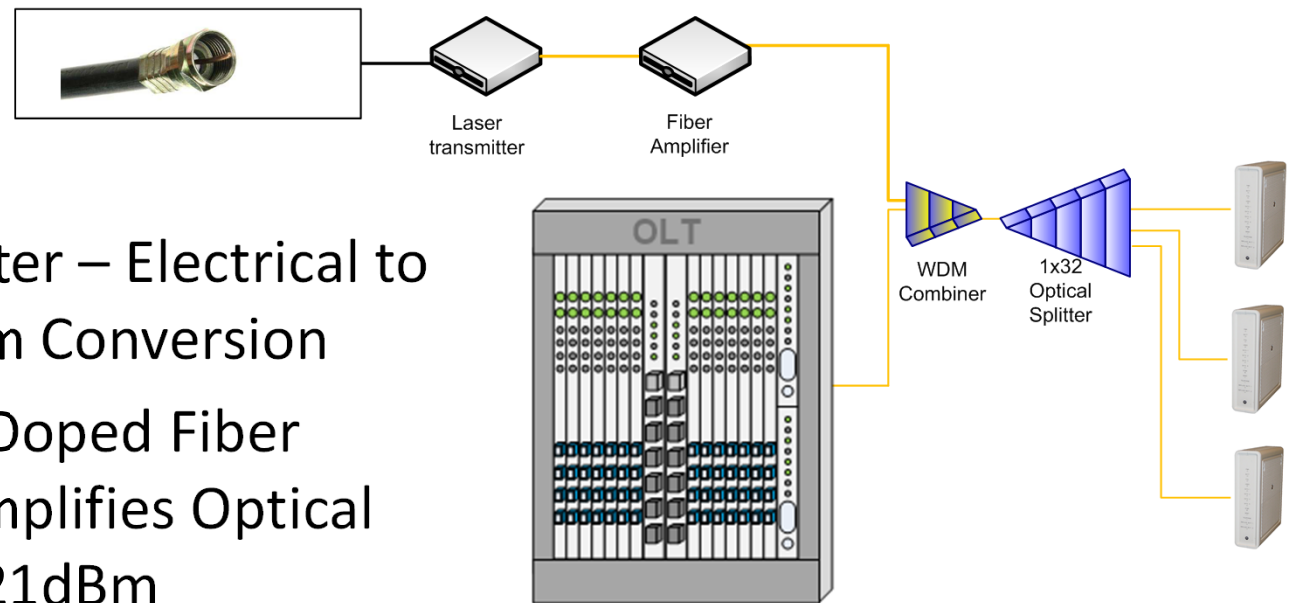

- Laser Transmitter – Electrical to Optical 1550nm Conversion
- EDFA (Erbium Doped Fiber Amplifier) – Amplifies Optical Signal to 18 – 21dBm
- WDM – Combines Wavelengths

Components - Video

- Laser Transmitter
- EDFA
- RF Nodes
- RFoG/two-way



Components – DC Power

- Most OLTs use -48V DC Power
- Same power used in telco central offices
- Rectifiers required to convert AC to DC
- Properly ground your equipment!



Components – DC Power



- Redundant Inputs
- Redundant Outputs
- Redundant Rectifiers
- Fuse or Circuit Breaker Protection
- Network Management
- Basically an external power supply!



Centralized Management

- ONTs Centrally Managed
- No physical ONT management ports
- Same concepts as traditional network
 - VLANs
 - PoE
 - QoS



Centralized Management

The Zhone NMS interface features a top navigation bar with 'Home Services Faults Administration' and a 'Logged in as: admin' indicator. A sidebar on the left contains a 'Dashboard' menu with options like 'CONFIGURATION', 'ALARMS', 'SERVICES', 'PERFORMANCE', 'ADMINISTRATION', 'REPORTS', and 'SERVER'. The main area displays several panels: 'CONFIGURATION' with icons for Network Elements, Reports, and Server; 'ALARMS' with a table of alerts; 'BANDWIDTH UTILIZATIONS' with a bar chart; and 'USERS' with a pie chart.

DeviceName	Type	Name	Description
Mat 01:38172.16	Device_AlarmEvent	DEVICE_REACH	The device is not reachable
Shore Mac172.16	Device_AlarmEvent	POWER_SUPPLY_1B	Power supply 1 failure
172.16.88.198	Device_AlarmEvent	POWER_SUPPLY_1B	Power supply 1 failure
Mat 01:38172.16	Device_AlarmEvent	POWER_SUPPLY_1B	Power supply 1 failure
Mat 01:38172.16	Device_AlarmEvent	PULL_UPSTATE_2A	A full config sync update has failed
Shore Mac172.16	Card_AlarmEvent	CARD_FAULT_2B	Card fault error
172.16.88.198	Physical_AlarmEvent	L2M_COV_M_ALARM	Ethernet communication link is down (1:18-1:0)
172.16.88.198	Physical_AlarmEvent	L2M_COV_M_ALARM	Ethernet communication link is down (1:18-2:0)
172.16.88.198	Physical_AlarmEvent	L2M_COV_M_ALARM	Ethernet communication link is down (1:18-3:0)
172.16.88.198	Physical_AlarmEvent	L2M_COV_M_ALARM	Ethernet communication link is down (1:18-4:0)
172.16.88.198	Physical_AlarmEvent	L2M_COV_M_ALARM	Ethernet communication link is down (1:18-5:0)
172.16.88.198	Physical_AlarmEvent	L2M_COV_M_ALARM	Ethernet communication link is down (1:18-6:0)
172.16.88.198	Physical_AlarmEvent	L2M_COV_M_ALARM	Ethernet communication link is down (1:18-7:0)
172.16.88.198	Physical_AlarmEvent	L2M_COV_M_ALARM	Ethernet communication link is down (1:18-8:0)

The Tellabs Panorama PON interface shows a hierarchical network tree on the left with categories like Network, BigD, MDS, 4xGPON, and PON. The main area displays a detailed view of a 'BigD @ 08 00UJ @ 01 PON' device, showing a rack of optical line terminals (OLTs) and their corresponding ports. The interface includes a top menu bar (File, Edit, View, Profiles, Tools, Windows, Help) and a bottom status bar showing the user 'emsadmin' is logged on.



Management Systems

- Systems included standard CLI and EMS
- OLT runs without management server
- Application and Web/Mobile
- GUI is more important in PON than legacy networks
 - Density is far greater!
- ONTs are an extension of the OLT



Profiles & Templates

- Create a standard profile or template for your services
- Apply that profile or template to many ONTs at once!



Management Systems Features

- Alarming and Notification
- Bandwidth Monitoring
- Central OLT & ONT Upgrades
- MAC Searches
- VLAN Member Reports



Bandwidth Management

- Bandwidth Management is Built-in!
- Guarantee every user bandwidth
 - Set a committed rate
 - Committed rates cannot exceed capacity of any link in the system
- Manage additional bandwidth as you desire
 - Set a peak rate



Managing All The Same Things

The same things you manage today...

- VLANs
- PoE
- QoS
- LLDP
- Network Access Control



What makes PON a POL?

1. Indoor ONTs
2. Power over Ethernet
3. Internal Packet Switching
4. Enterprise Ethernet Features



Questions?

Introduction to POL Components

Matt Miller

Sr. Solutions Architect, CallisonRTKL



Introduction to POL Design



Bicsi



Section 9 Agenda

- POL Component and Budget Reveiw
- POL Cable Design Options Overview
- Design Challenge Exercise
- Knowledge Check



APC and UPC

- Ultra Physical Contact Connectors (UPC)

- Blue



- Angled Physical Connectors (APC)

- Green



Splitter Deployment

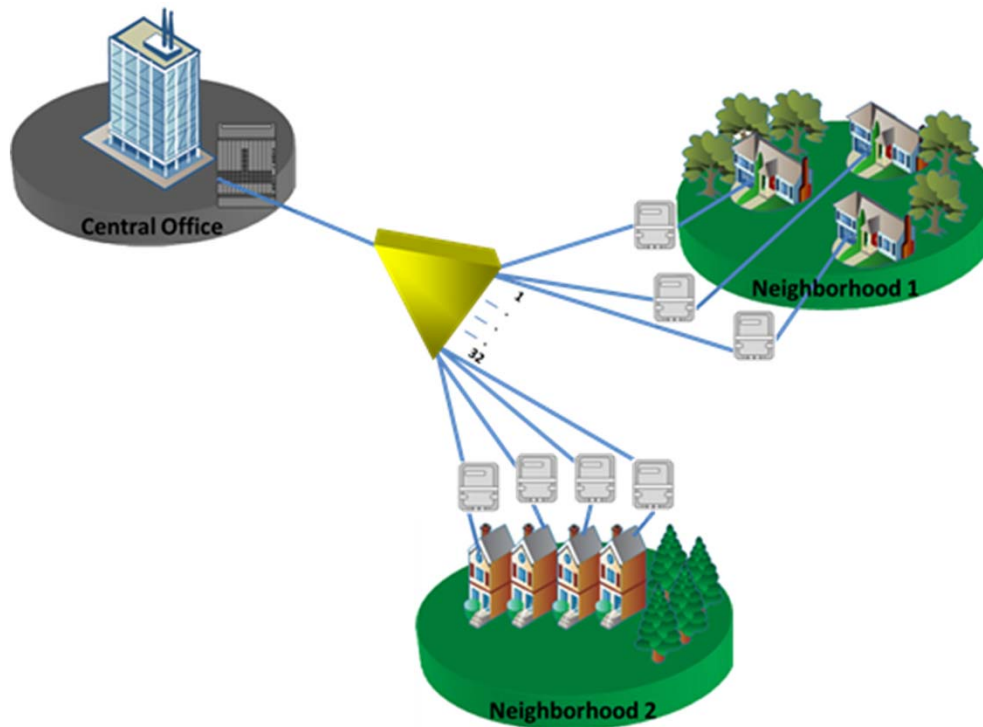

Single Splitter

- One splitter in the Optical Distribution Network
- All splitter loss is at one location
- Works for 99% of POL deployments

Splitter Deployment

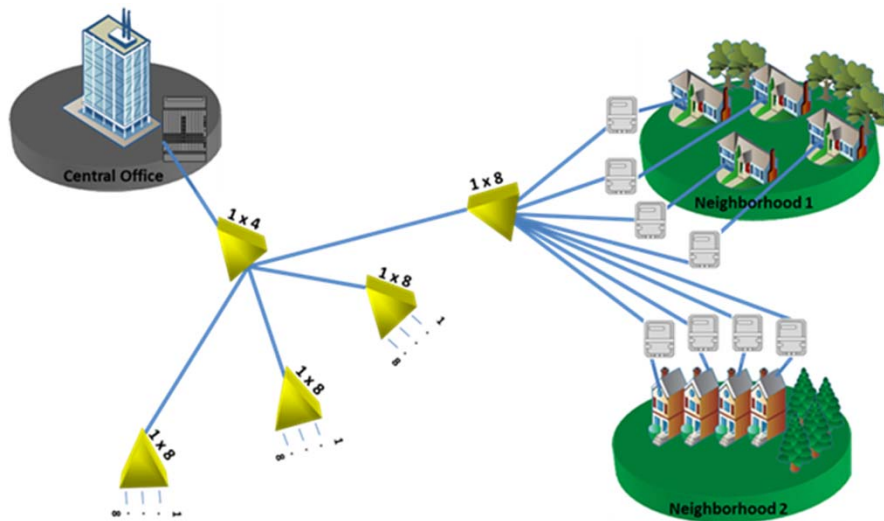

Cascaded Splits

- Used when end users are geographically dispersed
- Campus out-buildings
- Loss from splitters in path must be summed

Engineered Splits

- Loss may favor a particular output

Centralized Split Overview

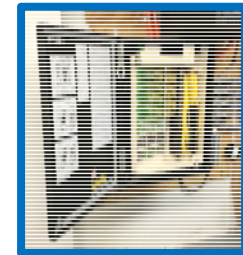
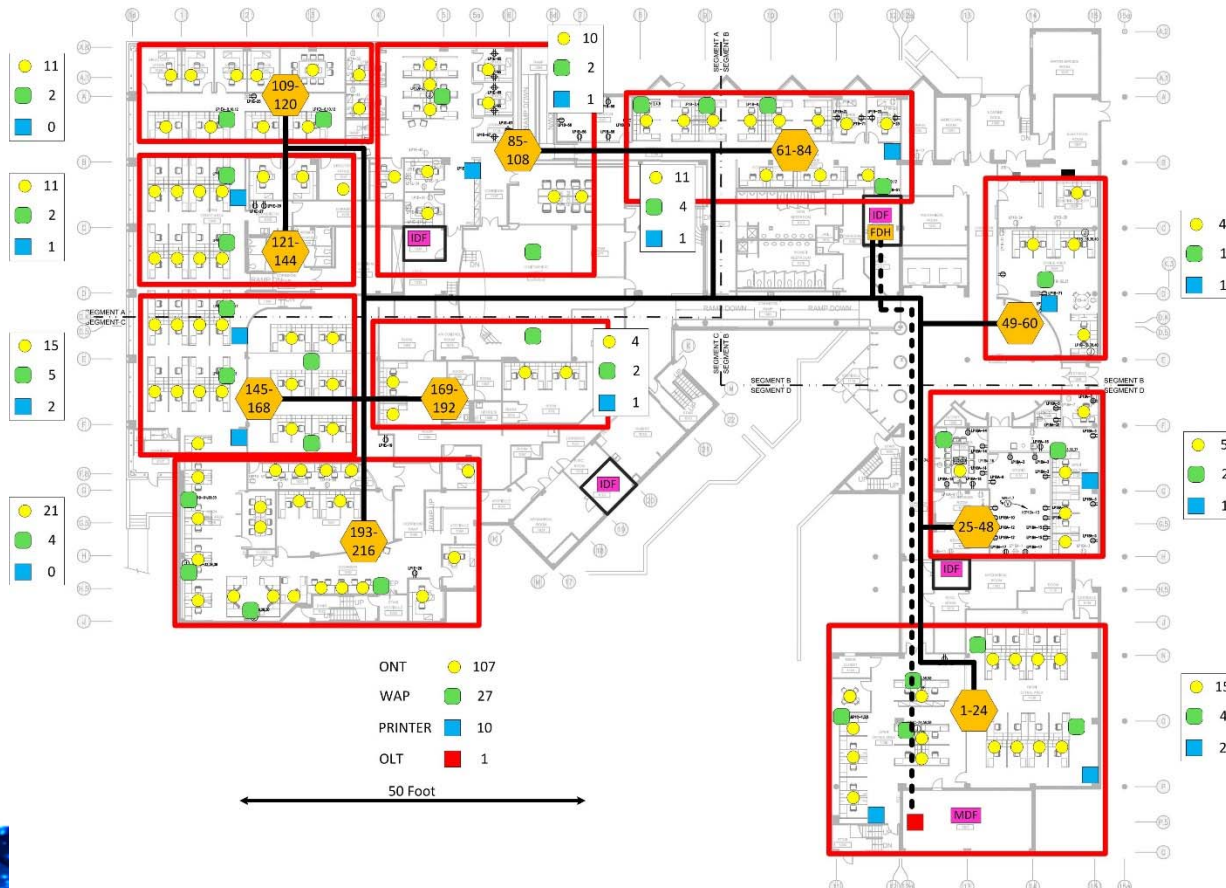

FDH
Houses Splitters

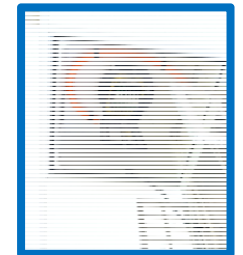

Consolidation Point
Zone Cabling



Centralized Splitting

- Provides maximum ROI for POL
- Houses splitters in one location per floor
- Installation Labor hours are reduced
- Connection between Riser and Horizontal



Centralized BoM

Area	Product Description	Total Qty
MDF	Rack Mount Fiber Enclosure, 1U, holds 3 MPO Fiber cassettes	
MDF	MPO Fiber Cassete	
IDF	1 x 32 splitter used with FDH	
IDF	288-Port capacity FDH accommodating 18 splitters and 24 MPO outputs	
Horizontal	24 port Consolidation Point w/300 foot Plenum MPO Cable	
ONT Fiber	SCAPC-SCAPC Plenum Yellow 3 (10')	
OLT Fiber	SCUPC-SCAPC Plenum Yellow 8 (25')	
Horizontal	SCAPC-SCAPC Plenum Yellow 23 (75')	
Horizontal	SCAPC-SCAPC Plenum Yellow 31 (100')	
Horizontal	SCAPC-SCAPC Plenum Yellow 38 (125')	
Horizontal	SCAPC-SCAPC Plenum Yellow 46 (150')	
WOA	4-port White Faceplate	
WOA	SCAPC Singlemode adapter	
WOA	Category 6 modular jack	
WOA	RJ45 plug to RJ45 plug, T568B Blue	



Zone Split Overview



Zone Splitter Housing

Bicsi



Zone Splitting

- Eliminates the need for the IDF
- Places Splitter closer to user
- Location for cross-connects
- Termination for horizontal and feeder fiber
- Moves redundancy closer to the user in Type B applications.



Zone BoM

Area	Product Description	Total Qty
MDF	Rack Mount Fiber Enclosure, 2U, holds 6 MPO Fiber cassettes	
MDF	MPO Fiber Cassete	
IDF	MPO Fiber Trunk 12 Strand Singlemode Plenum (100 foot)	
IDF	MPO Fiber Trunk 12 Strand Singlemode Plenum (200 foot)	
IDF	MPO Fiber Trunk 12 Strand Singlemode Plenum (300 foot)	
Horizontal	1 x 32	
Horizontal	Fiber Zone Box	
Horizontal	Fiber Zone Box Installation Kit	
ONT Fiber	SCAPC-SCAPC Plenum Yellow 3 (10')	
OLT Fiber	SCUPC-SCAPC Plenum Yellow 8 (25')	
Horizontal	SCAPC-SCAPC Plenum Yellow 23 (75')	
Horizontal	SCAPC-SCAPC Plenum Yellow 31 (100')	
Horizontal	SCAPC-SCAPC Plenum Yellow 38 (125')	
Horizontal	SCAPC-SCAPC Plenum Yellow 46 (150')	
WOA	Faceplates 4-port White Alpine	
WOA	SCAPC Singlemode adapter	
WOA	Category 6 modular jack	
WOA	RJ45 plug to RJ45 plug, T568B Blue	



Rack Mount Split Overview

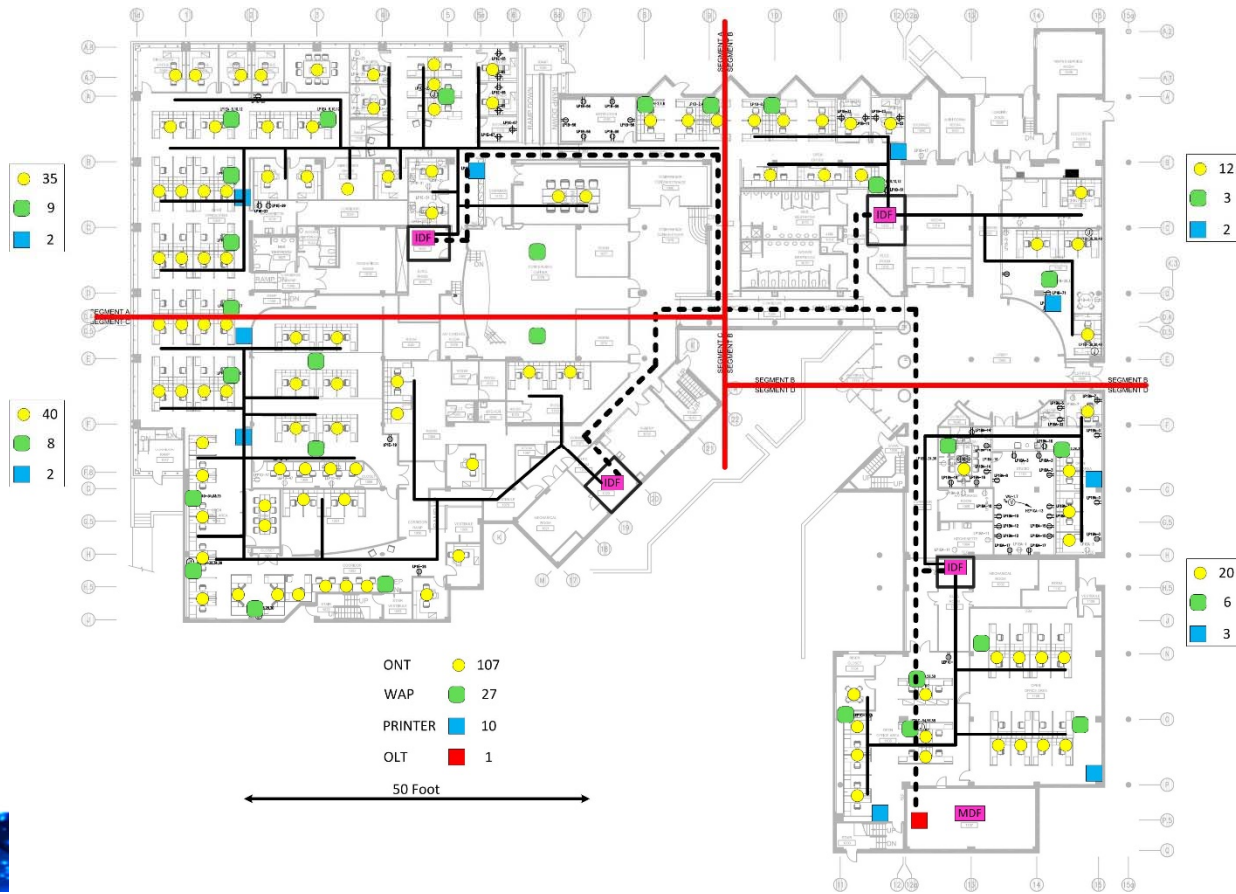

Rack Mount Splitting

- Customer used to look and feel
- Splitters are rack-mounted or installed in fiber housing modules
- Fiber is terminated on patch panels
- Can use Pre-terminated or field connectorized cable



Rack BoM

Area	Product Description	Total Qty
MDF	Rack Mount Fiber Enclosure, 2U, holds 6 MPO Fiber cassettes	
MDF/IDF	MPO Fiber Cassete	
IDF	Wall Mount 2-Post Open Frame Rack Cabinet 8U	
IDF	Rack Mount Fiber Enclosure, 1U, holds 2 MPO Fiber cassettes	
IDF	Rack Mount Fiber Enclosure, 2U, holds 6 Panels	
IDF	SC Adapters, Simplex, APC, 12 F, Single-mode	
Riser	MPO Fiber Trunk 12 Strand Singlemode Plenum (100 foot)	
Riser	MPO Fiber Trunk 12 Strand Singlemode Plenum (200 foot)	
Riser	MPO Fiber Trunk 12 Strand Singlemode Plenum (300 foot)	
IDF	Rack Mounted 1 x 32 splitter	
ONT Fiber	SCAPC-SCAPC Plenum Yellow 3 (10')	
OLT Fiber	SCUPC-SCAPC Plenum Yellow 8 (25')	
Horizontal	SCAPC-SCAPC Plenum Yellow 23 (75')	
Horizontal	SCAPC-SCAPC Plenum Yellow 31 (100')	
Horizontal	SCAPC-SCAPC Plenum Yellow 38 (125')	
Horizontal	SCAPC-SCAPC Plenum Yellow 46 (150')	
WOA	Faceplates 4-port White Alpine	
WOA	SCAPC Singlemode adapter	
WOA	Category 6 modular jack	
WOA	RJ45 plug to RJ45 plug, T568B Blue	



Hybrid Deployments

- Some deployments choosing hybrid deployments
- Hybrid Ideas
 - Keep IDFs for rack-mount ONTs, but use fiber zone hubs
 - Put ONTs in active zone box and run category cabling to user
 - Use 100% rack-mount ONTs in retrofit scenario



Campus Overview

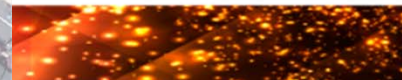
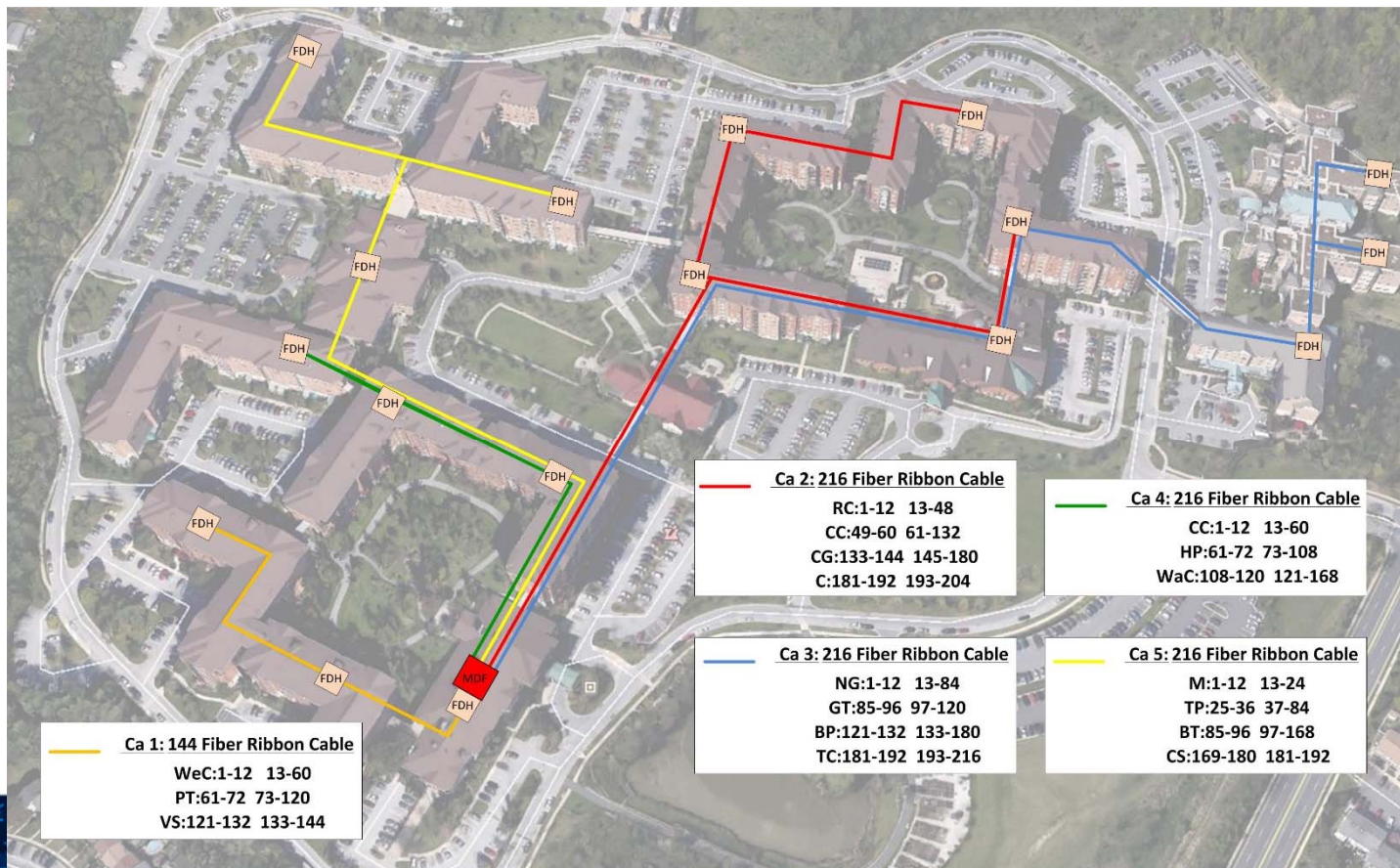

OSP Deployment

- OSP options can be mixed with LAN options
- Be careful of mixing manufacturer product lines due to incompatibility issues
- Many options due to PON history in telecommunications



Good Design Practices

- ✓ Meets customer requirements
- ✓ Provides a value to the customer:
 - ✓ Reduced Cost
 - ✓ Power/Space/Cooling
 - ✓ Performance
 - ✓ Longevity
- ✓ Is not overly complex
- ✓ Makes customer happy!



End of Day One

Founding Members:



www.apolanglobal.org

Bicsi



Day 1 Review

Sean Kelly, RCDD



Bicsi



Passive Optical LAN is a standards based/recognized technology

- ✓ A. True
- B. False

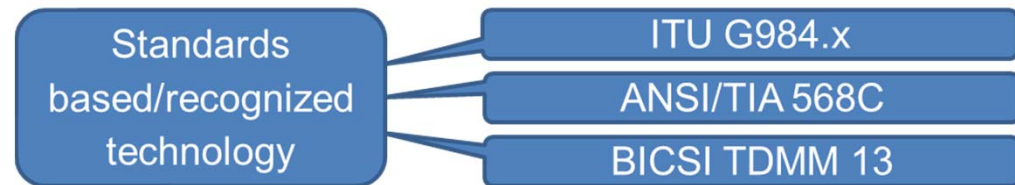

Guaranteed bandwidth is possible with...

- ✓ A. Passive Optical LAN
- B. Switch Based
- C. Both A and B

Similar

Standards Based

Local Area Network

Enterprise Management

Ethernet Frame Transport

802.1x – 802.1Q – PoE

Different

Point to Multipoint

Multiple Services

Guaranteed Bandwidth

Single Strand of SM Fiber

No Access and Distribution



POL supports 802.1Q VLANs

- ✓ A. True
- B. False

Similar

Standards Based

Local Area Network

Enterprise Management

Ethernet Frame Transport

802.1x – 802.1Q – PoE

Different

Point to Multipoint

Multiple Services

Guaranteed Bandwidth

Single Strand of SM Fiber

No Access and Distribution

AES 128 Encryption is present in _____ direction(s)

- A. The upstream
- ✓ B. The downstream
- C. Both upstream and downstream

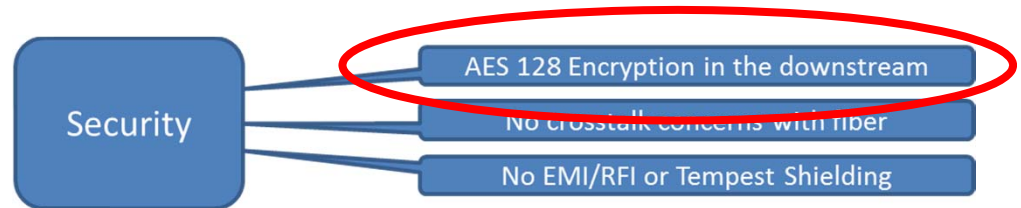

Gigabit switches provide 1Gb/s connections to every WAO

- A. True
- ✓ B. False

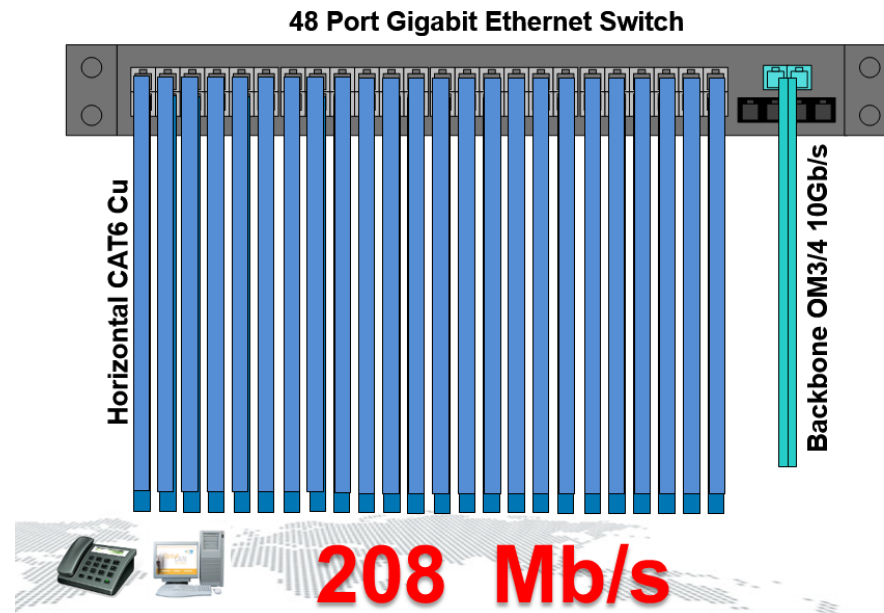

Most users consume bandwidth all day long

- A. True
- ✓ B. False

Most users use 0Mb/s over 98% of the workday

Apps (7)

- ▷ Microsoft Lync (32 bit)
- ▷ Microsoft Outlook (32 bit) (2)
- ▷ Microsoft PowerPoint (32 bit)
- ▷ Photos
- ▷ Snipping Tool
- ▷ Task Manager
- ▷ Windows Explorer

0%	55.8 MB	0 MB/s	0.1 Mbps
0%	92.6 MB	0 MB/s	0 Mbps
2.3%	192.5 MB	0 MB/s	0 Mbps
0%	0.1 MB	0 MB/s	0 Mbps
0%	2.2 MB	0 MB/s	0 Mbps
1.6%	10.8 MB	0 MB/s	0 Mbps
1.4%	147.3 MB	0 MB/s	0 Mbps



This technology uses Dynamic Bandwidth Allocation

A. Switch Based

✓ B. Passive Optical LAN

Switch Data vs. Dynamic Bandwidth Allocation



Most users require a sustained GbE connection

- A. True
- ✓ B. False

Common LAN Services	Typical Required Bandwidth
Email and Web Browsing	500Kbps
Voice over IP	110Kbps
Cloud-based Services (data storage, enterprise s/w, collaboration, etc...) Low	50Kbps
Cloud-based Services (data storage, enterprise s/w, collaboration, etc...) High	100Kbps
Wireless Access Point Capacity (IEEE 802.11 a/b/g/n)	24Mbps
Wireless Access Point High Capacity (IEEE 802.11 ac/ad, dual radio)	300Mbps
IP Video Surveillance Standard Definition (MPEG4/H.264)	2Mbps
IP Video Surveillance High Definition (MPEG4/H.264)	6Mbps
IP Video Conferencing / Telepresence (720p-Good, includes primary/auxiliary)	2Mbps
IP Video Conferencing / Telepresence (1080p-Best, includes primary/auxiliary)	15Mbps

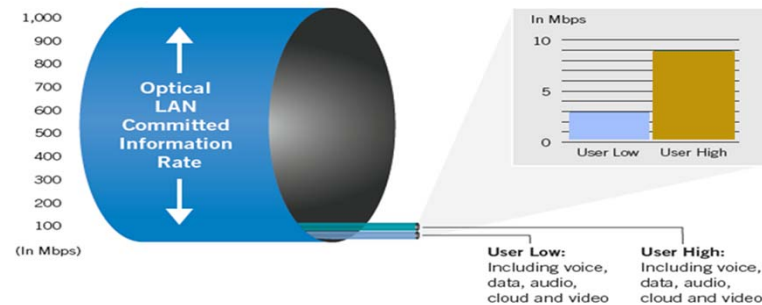

Upstream (ONT to OLT) analog video utilizes which wavelength?

A. 1550nm

B. 1490nm

C. 1310nm

D. 1625nm

✓ E. None



1550nm Downstream ONLY –
RF Video



A cascaded 1x4 + 1x16 split is a good practice?

- A. True
- ✓ B. False

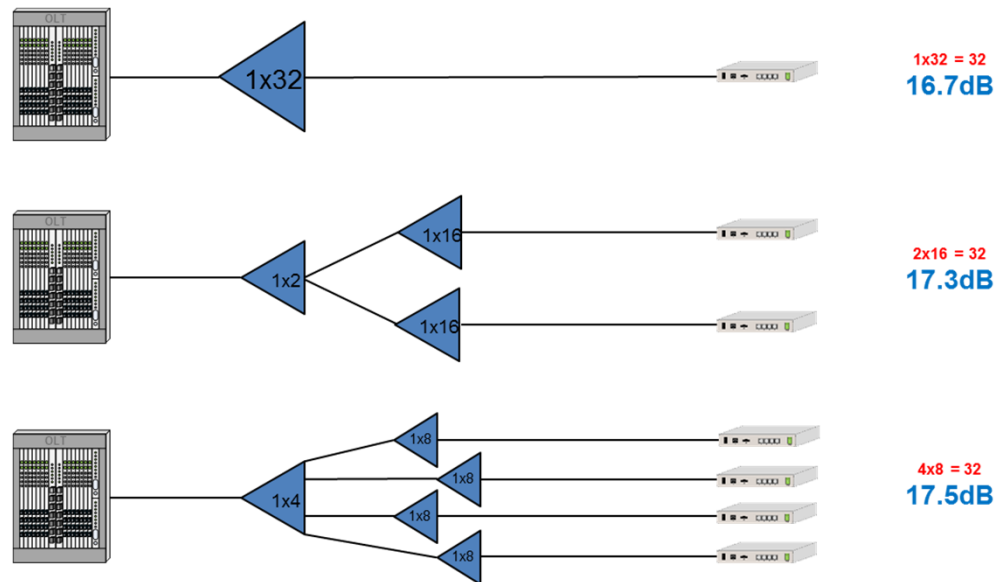

GPON bandwidth can be increased by using a lower split ratio

- A. True
- ✓ B. False

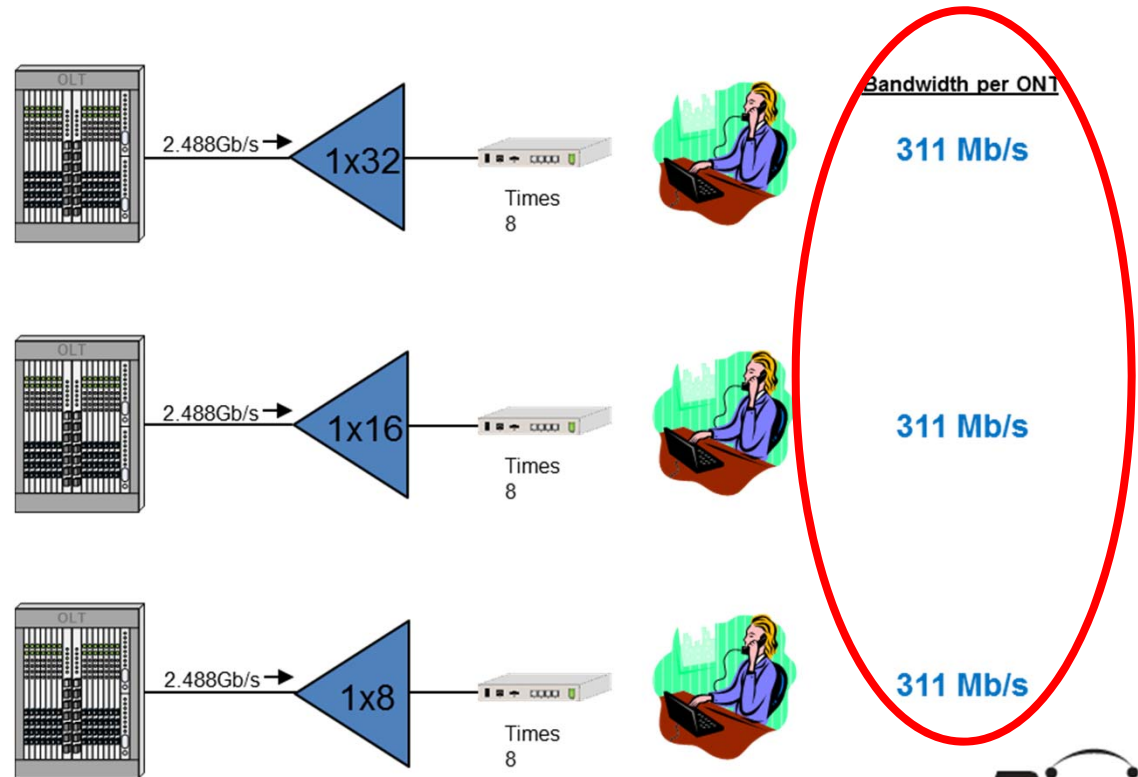

The minimum loss required between the OLT and ONT is...

- A. 13.5dB
- B. 10.7dB
- ✓ C. 15.5dB
- D. 17.2dB
- E. None of these

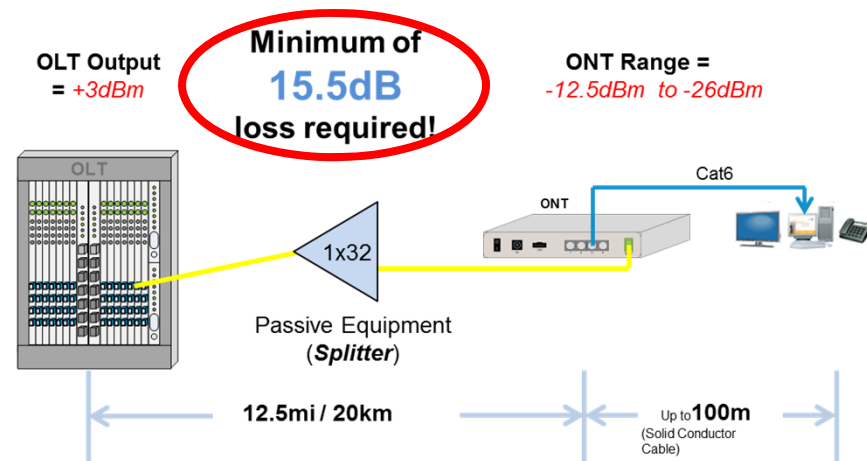

PoE in a POL is administered at the...

- A. OLT
- ✓ B. ONT
- C. Injector
- D. PoE is not possible

ONT – Optical Network Terminal

- Active equipment provided by suppliers such as Tellabs and Zhone.
- Located near the user or device
- Typically 4 RJ45 (10/100/1000) outputs with optional POE
- Up to 60W of available POE (vendor specific)
- Standard HVAC is adequate
- Optional internal or external battery back-up
- POTS and COAX ports available
- Establishes and maintains secure AES 128 Encryption
- Supports multiple VLANs on each port



ONT

Which of these are a benefit of POL?

- A. Reduction in power
- B. Reduction of fire load
- C. Reduction of non-renewable materials
- ✓ D. All of these are benefits

Green Benefits

- Reduction in power consumption
- Reduction in non-renewable materials
- Ceiling space and fire load savings
- Reduction in cabling costs
- Floor space savings



LEED Credits are

- ✓ A. Possible with POL
- B. Automatic with POL
- C. Guaranteed with POL
- D. Not Possible with POL

- Energy and Atmosphere Credit 1 (1-3 pts).
 - Reduction in TRs, HVAC equipment, switch equipment, UPS, lighting and other energy needs.
 - The PON system helps the overall efficiency of the energy systems.
- Innovation in Design Credit 1 (1-4 pts).
 - The PON system utilizes less equipment, resulting in less raw materials, less garbage, less transportation and reduced time for implementation and commissioning.
 - In addition, utilizing a fiber system ensures the life of the system extends beyond the life of a conventional “switched” system.



*not guaranteed or implied



My retained knowledge of Passive Optical LAN from yesterday was...

- A. A little
- B. A lot
- C. What is Passive Optical LAN?
- D. None



Questions?

Day 1 Review

Sean P. Kelly, RCDD

Bicsi



Design Scenario Challenge

Challenge – Determine the quantity of each component required for Passive Optical LAN design

Assumptions:

1. Using pre-terminated fiber throughout
2. ONTs will be shared at Cubicles
3. ONTs will be mounted under the desks
4. ONTs will be locally AC powered
5. OLT is located in MDF
6. Raised floor throughout building

OLT	1
ONT's	107
WAP's	26
Printers	9



Assumptions

1. Using pre-terminated fiber throughout
2. ONTs will be shared at Cubicles
3. ONTs will be mounted under the desks
4. ONTs will be locally AC powered
5. OLT is located in MDF
6. Raised floor throughout building

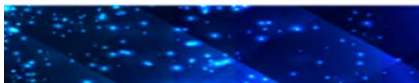

15 Minute Break



Please respect others and return on time.

Bicsi



Centralized Split Overview

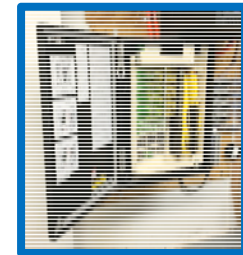
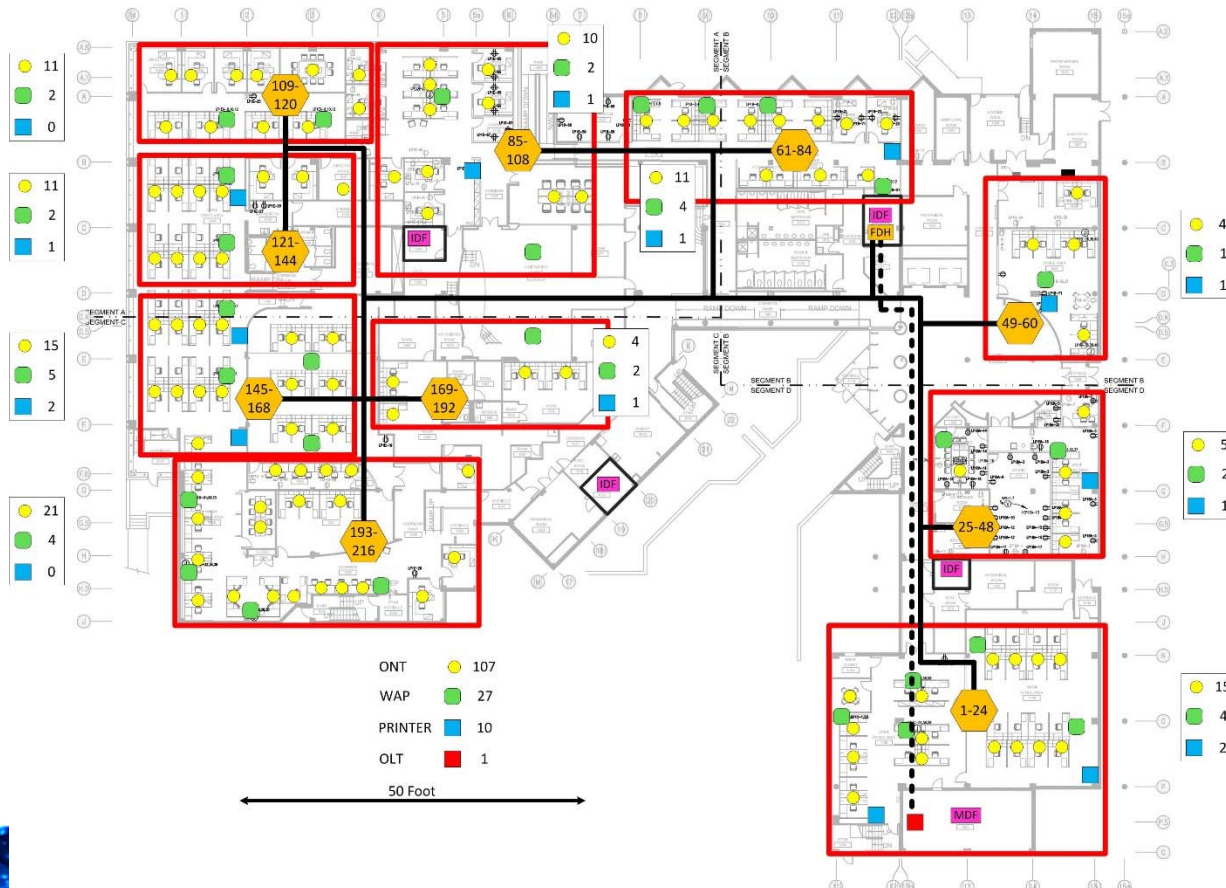

**FDH
Houses Splitters**

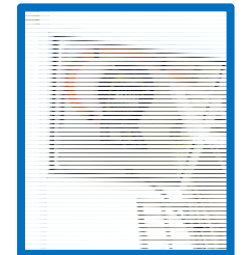

**Consolidation Point
Zone Cabling**

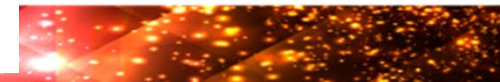

Centralized Scenario Answers

Area	Product Description	Total Qty
MDF	Rack Mount Fiber Enclosure, 1U, holds 3 MPO Fiber cassettes	1
MDF	MPO Fiber Cassete	2
IDF	1 x 32 splitter used with FDH	4
IDF	288-Port with 18 splitter ports 500' 24 MPO adapters	1
Horizontal	24 port Fiber Terminals w/300 foot Plenum Cable w/MPO	10
ONT Fiber	SCAPC-SCAPC Plenum Yellow 3 (10')	107
OLT Fiber	SCUPC-SCAPC Plenum Yellow 8 (25')	4
Horizontal	SCAPC-SCAPC Plenum Yellow 23 (75')	30
Horizontal	SCAPC-SCAPC Plenum Yellow 31 (100')	40
Horizontal	SCAPC-SCAPC Plenum Yellow 38 (125')	30
Horizontal	SCAPC-SCAPC Plenum Yellow 46 (150')	10
WOA	4-port White Faceplate	107
WOA	SCAPC Singlemode adapter	107
WOA	Category 6 modular jack	37
WOA	RJ45 plug to RJ45 plug, T568B Blue	251



Zone Split Overview



Zone Splitter Housing

Bicsi



Zone Scenario Answers

Area	Product Description	Total Qty
MDF	Rack Mount Fiber Enclosure, 2U, holds 6 MPO Fiber cassettes	1
MDF	MPO Fiber Cassete	5
IDF	MPO Fiber Trunk 12 Strand Singlemode Plenum (100 foot)	1
IDF	MPO Fiber Trunk 12 Strand Singlemode Plenum (200 foot)	2
Horizontal	MPO Fiber Trunk 12 Strand Singlemode Plenum (300 foot)	2
Horizontal	1 x 32	5
Horizontal	Fiber Zone Box	5
Horizontal	Fiber Zone Box Installation Kit	5
ONT Fiber	SCAPC-SCAPC Plenum Yellow 3 (10')	107
OLT Fiber	SCUPC-SCAPC Plenum Yellow 8 (25')	5
Horizontal	SCAPC-SCAPC Plenum Yellow 23 (75')	10
Horizontal	SCAPC-SCAPC Plenum Yellow 31 (100')	40
Horizontal	SCAPC-SCAPC Plenum Yellow 38 (125')	30
Horizontal	SCAPC-SCAPC Plenum Yellow 46 (150')	30
WOA	Faceplates 4-port White Alpine	107
WOA	SCAPC Singlemode adapter	107
WOA	Category 6 modular jack	37
WOA	RJ45 plug to RJ45 plug, T568B Blue	251



Rack Mount Split Overview

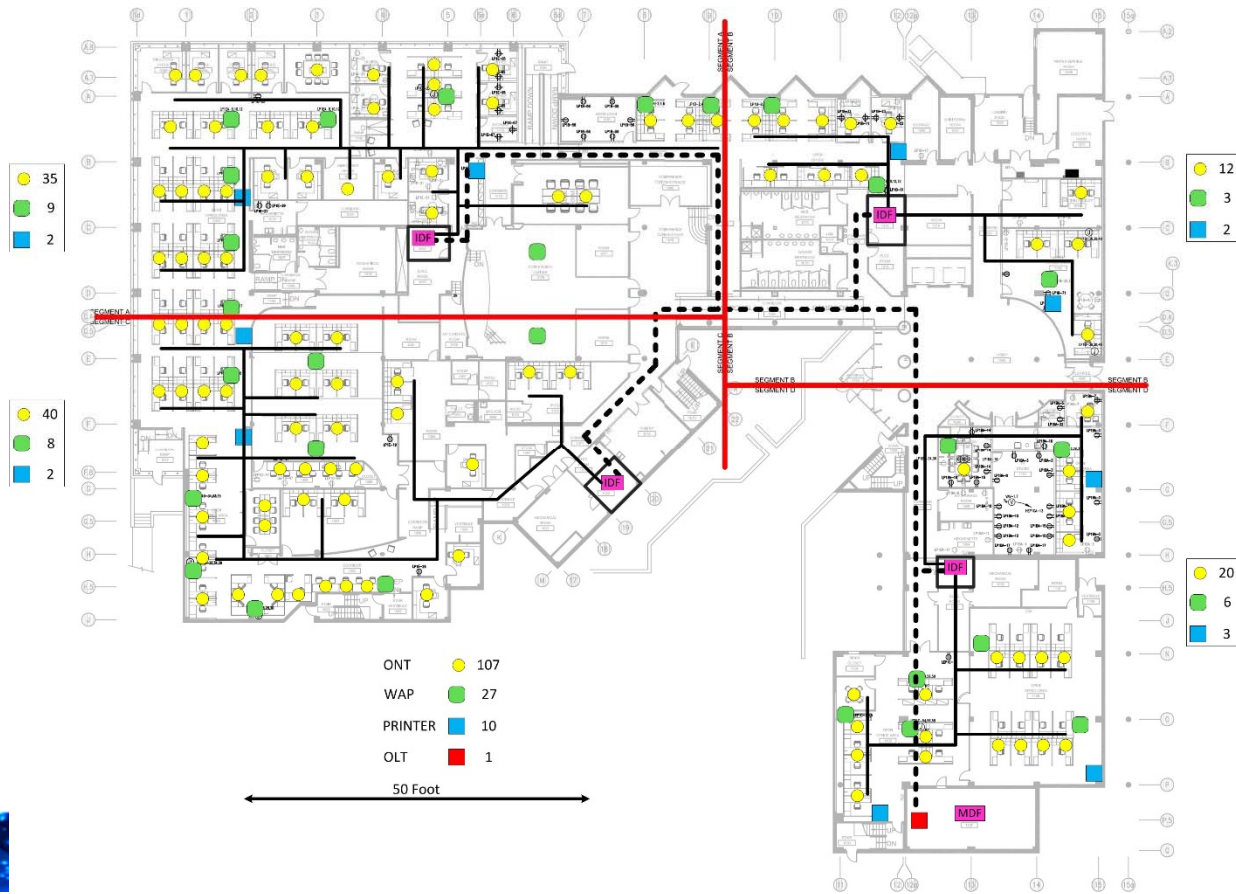

Rack Scenario Answers

Area	Product Description	Total Qty
MDF	Rack Mount Fiber Enclosure, 2U, holds 6 MPO Fiber cassettes	1
MDF/IDF	MPO Fiber Cassete	8
IDF	Wall Mount 2-Post Open Frame Rack Cabinet 8U	4
IDF	Rack Mount Fiber Enclosure, 1U, holds 2 MPO Fiber cassettes	4
IDF	Rack Mount Fiber Enclosure, 2U, holds 6 Panels	4
IDF	SC Adapters, Simplex, APC, 12 F, Single-mode	10
Riser	MPO Fiber Trunk 12 Strand Singlemode Plenum (100 foot)	1
Riser	MPO Fiber Trunk 12 Strand Singlemode Plenum (200 foot)	1
Riser	MPO Fiber Trunk 12 Strand Singlemode Plenum (300 foot)	2
IDF	Rack Mounted 1 x 32 splitter	6
ONT Fiber	SCAPC-SCAPC Plenum Yellow 3 (10')	107
OLT Fiber	SCUPC-SCAPC Plenum Yellow 8 (25')	6
Horizontal	SCAPC-SCAPC Plenum Yellow 23 (75')	30
Horizontal	SCAPC-SCAPC Plenum Yellow 31 (100')	40
Horizontal	SCAPC-SCAPC Plenum Yellow 38 (125')	30
Horizontal	SCAPC-SCAPC Plenum Yellow 46 (150')	10
WOA	Faceplates 4-port White Alpine	107
WOA	SCAPC Singlemode adapter	107
WOA	Category 6 modular jack	37
WOA	RJ45 plug to RJ45 plug, T568B Blue	251



Design Questions

- What design challenges do you see?
- What problems do you see POL solving?
- What problems do you see POL causing?



Questions?

Passive Optical LAN Design

Bicsi



Passive Optical LAN Power Survivability

Chad Hines
ITConnect, Inc.



Bicsi



Section 6 Agenda

- Survivability
- Verticals
- Types
- Hardware and Cabling
- When, Where, and How
- Knowledge Check



What is survivability

- Survivability: the capability of a system or organization to withstand a disaster or hostile environment, without significant impairment of its normal operations.



Why Would We Need Survivability



Bicsi



Power Over Ethernet Requirements

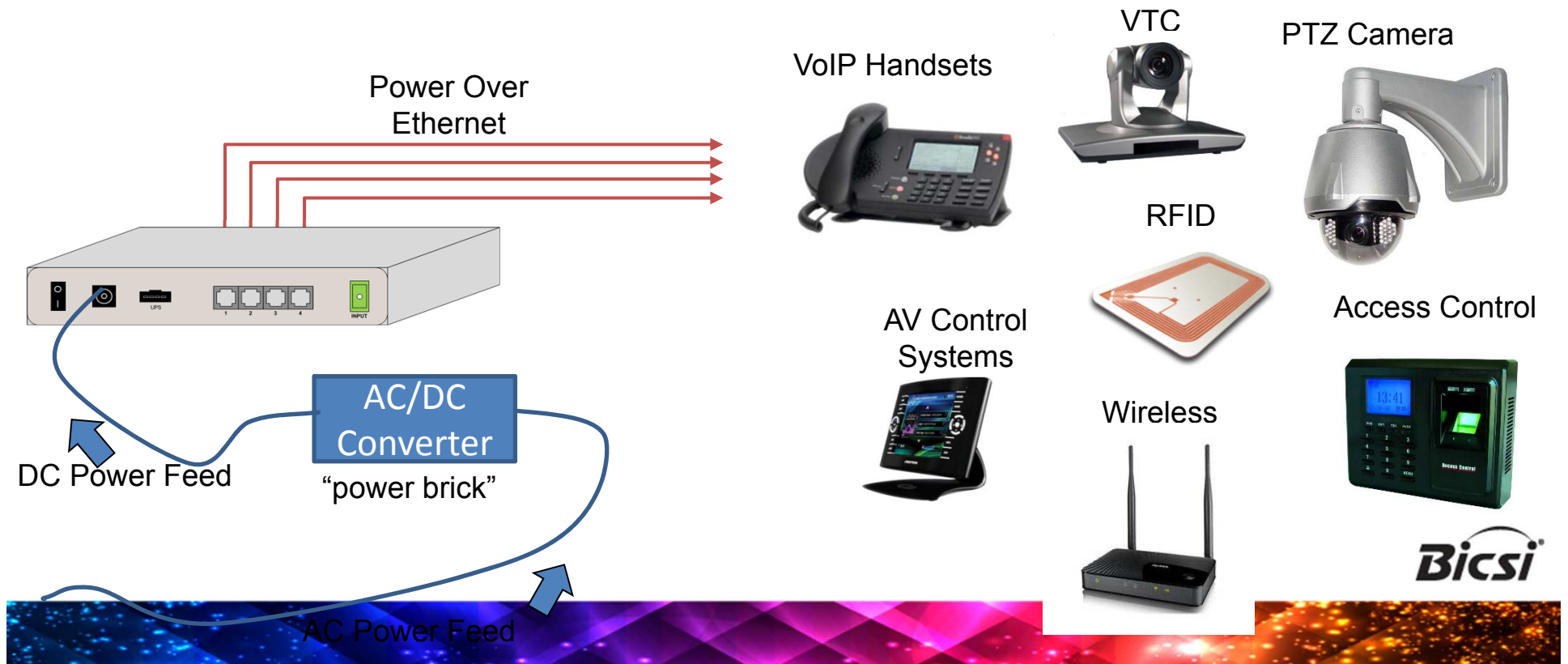

Non-PoE Requirements

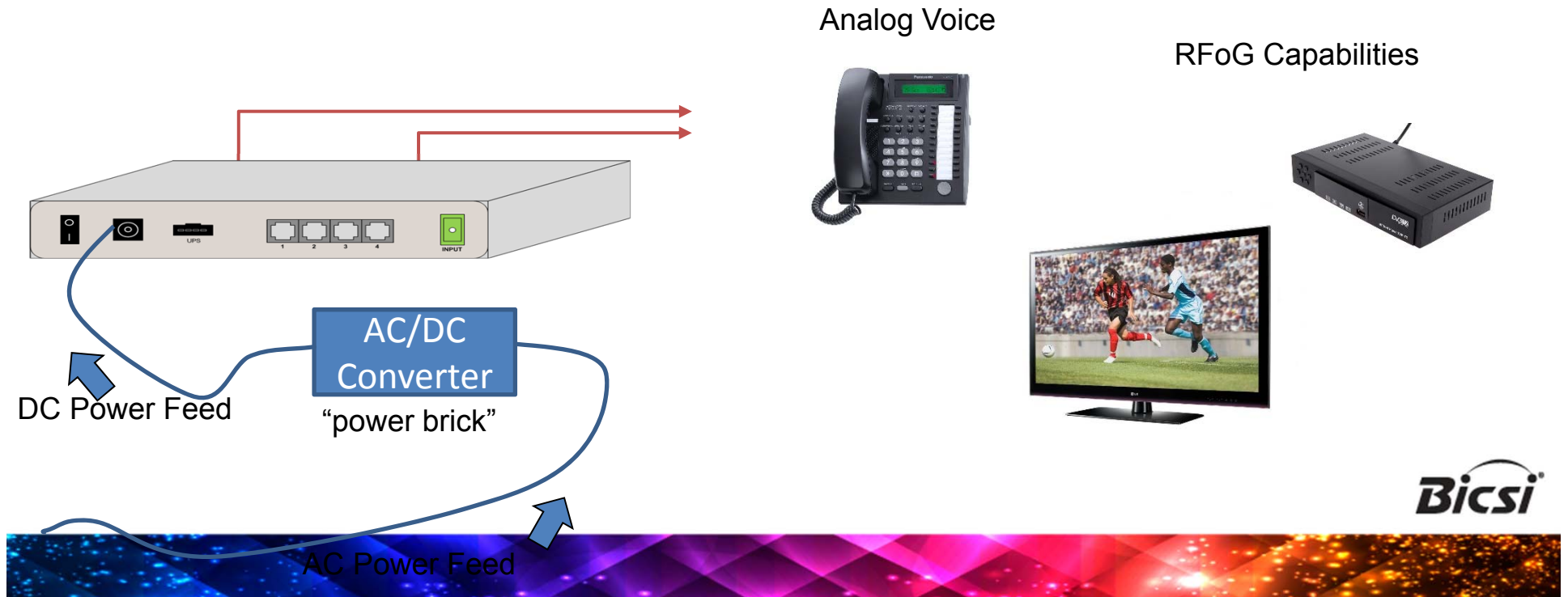

What's The Impact



ONT Placement Can Define Powering

AC = Local

DC = Remote



Wall-mount



Ceiling tile mount

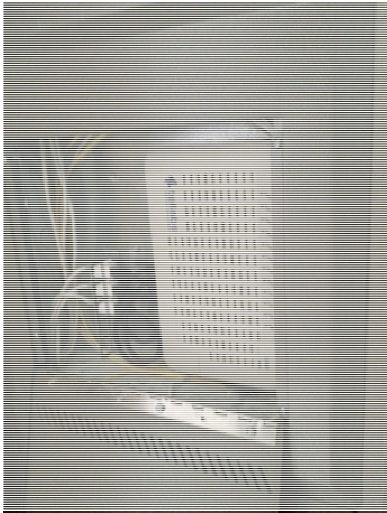

Secure Wall Box



Wall Plate ONT



Wall Plate ONT



Under-desk mount



Desktop



What Needs to Survive

VoIP Handsets



VTC



RFID

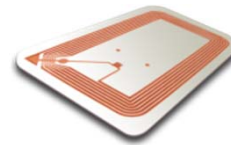

PTZ Camera



AV Control Systems



Wireless



Access Control



Call Centers/ DoD/ Financial



Healthcare





Hospitality



Bicsi



Commercial Business and Education



Bicsi



Different Ways to Survive

- Local battery
- Remote:
 - Powered
 - Battery
 - Generator
- AC power on generator
“Emergency power”

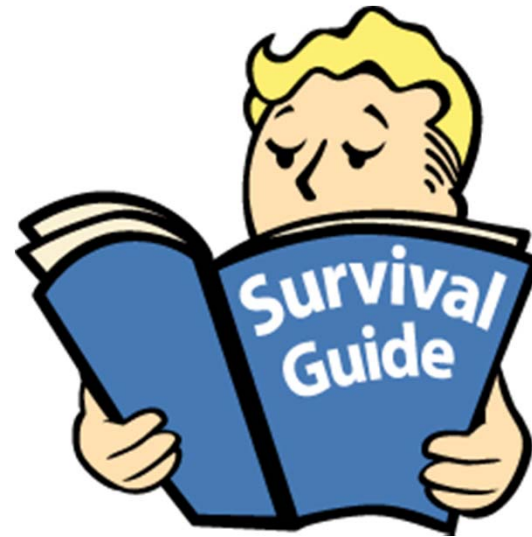

Local Batteries



Bicsi



Local Batteries

- PROs
 - Place them only where needed
 - Low cost/ commitment
 - May already be using UPS at desk
 - Does not require remote power for survivability
- CONs
 - Replacing when bad
 - Many more items to manage
 - Limited uptime
 - Battery failure



Remote Power

- Remote power means to power multiple ONTs from a DC power station which can be either distributed or centralized.
 - Distributed remote power is typically located in an IDF and can be powered with local AC or fed with DC power from the MDF
 - Centralized remote power is typically in the MDF and can feed distributed stations or directly feed ONTs at great distances
- Voltage options: 48vdc



Power Connectors

Locking preferred for remote power applications

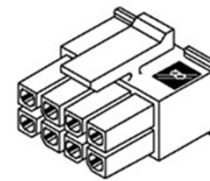

POE-PowerTop



Power Connectors

Non-locking connector
introduces risk



Power Connectors



Be
creative
but not
sloppy



48vdc Distributed

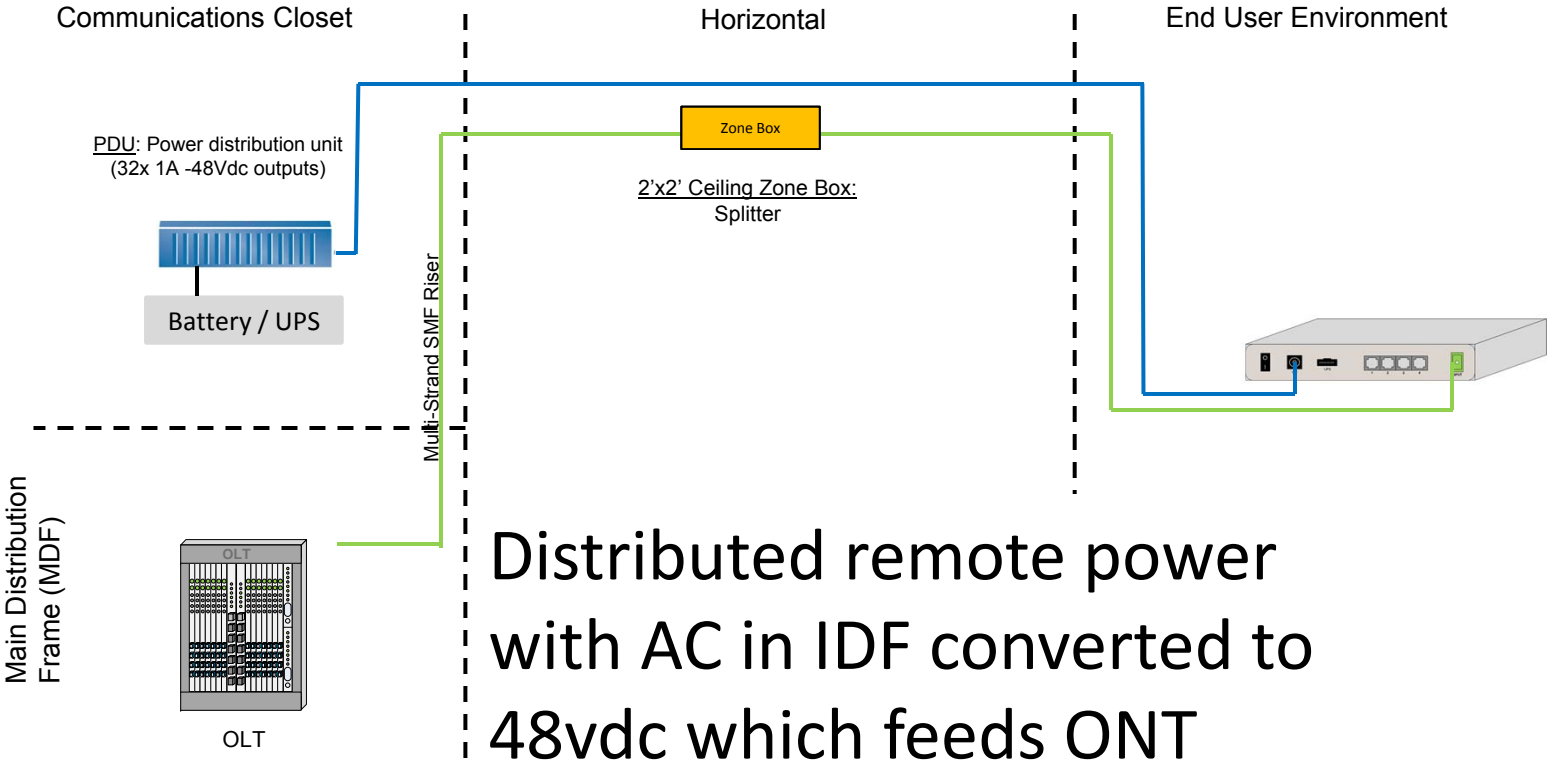

Distributed remote power with AC in IDF converted to 48vdc which feeds ONT



48vdc Centralized

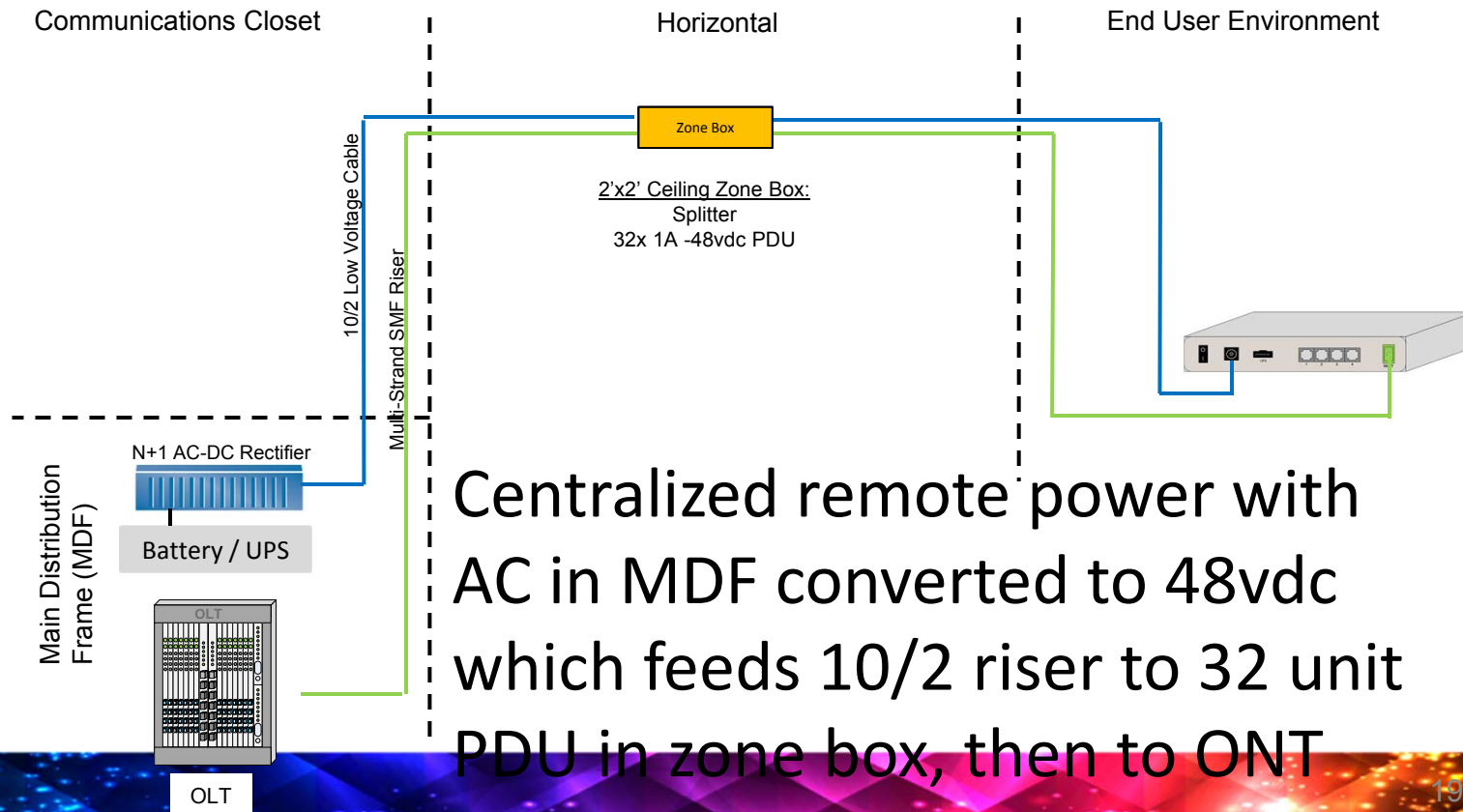

Remote Power

- PROs
 - Survivability
 - Eliminates AC plug at ONT
 - Centralizes battery backup
 - Remote power reset of an ONT
- CONs
 - Added CapEx and OpEx cost and complexity
 - Introducing additional items to manage
 - Limited up time for UPS (needs generator for continued service)
 - UPS battery failure/replacement
 - Additional infrastructure
 - Backbone exceeds NEC Class 2 requiring conduit and an electrician (*note: 48v Distributed does not exceed NEC Class 2)
 - Difficult to capture remote power reqs in non low voltage sec. of project specs
 - Determining wire gauge for 48v Centralized backbone (10/2)



Remote Power Caution

- What happens when you have a coil of copper cable and send constant DC voltage through it?
- Trimming to avoid the coil means you've limited future flexibility
- Wattage is limited by gauge of wire so you've just removed future-proofing
- Not all ONTs are 48vdc !



AC Generator Power

- Alternating Current (AC) power
 - Installed on dedicated “emergency” circuits
 - Circuits fed from dedicated panels
 - Panels powered with dedicated feeders from generator power



AC Generator Power

- PROs
 - Survivability
 - Eliminates need for remote 48vdc power solution
 - Not limited to run time of battery
- CONs
 - Added cost / complexity
 - Requires licensed electrician to install vs. low voltage contractor



Rectifier Hardware Options

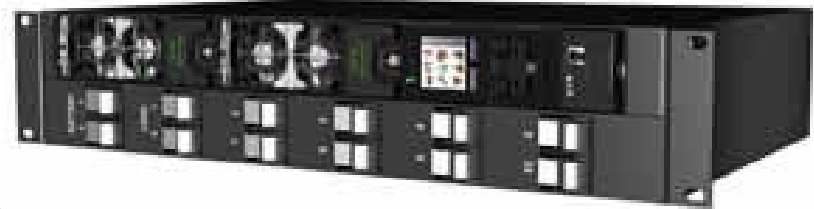

Bicsi



PDU Hardware Options



Cabling Options

- Solid vs. Stranded
- Hybrid composite cable
- Separate cables
- Use existing copper



Solid vs. Stranded Conductor

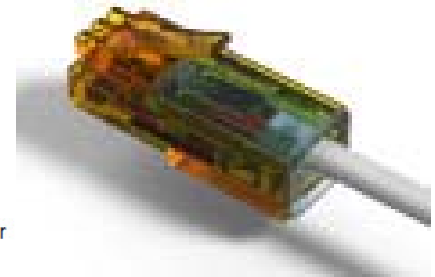
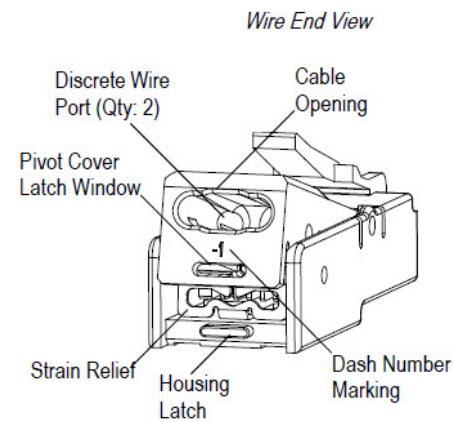
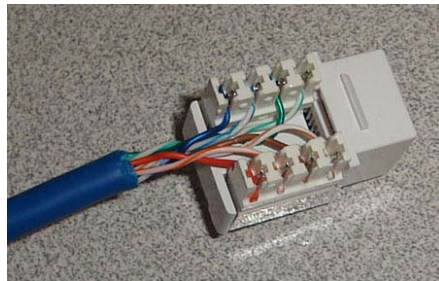

Solid vs. Stranded Conductor



Identifying Stranded VS. Solid RJ45s:



Composite Cable

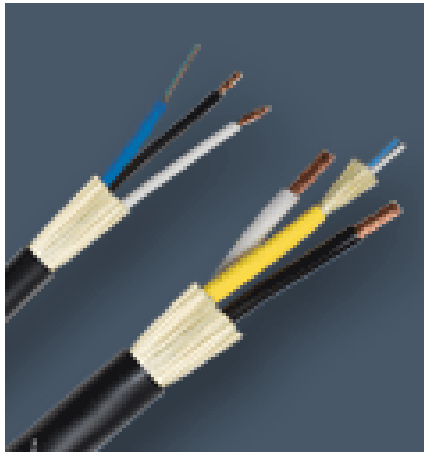

Separate Cables



Considerations for Cabling

- Will the copper and fiber originate in the same location? This will significantly impact your decision for Composite or Separate cables.
- Repurposing existing Cat-X cable as your power carrier is a benefit and reduces costs for cable and installation.



IDF Elevation

- Typical hospitality IDF will feed 3 floors
- 48vdc Distributed Remote Power
- Composite 18/2, 2-strand SM

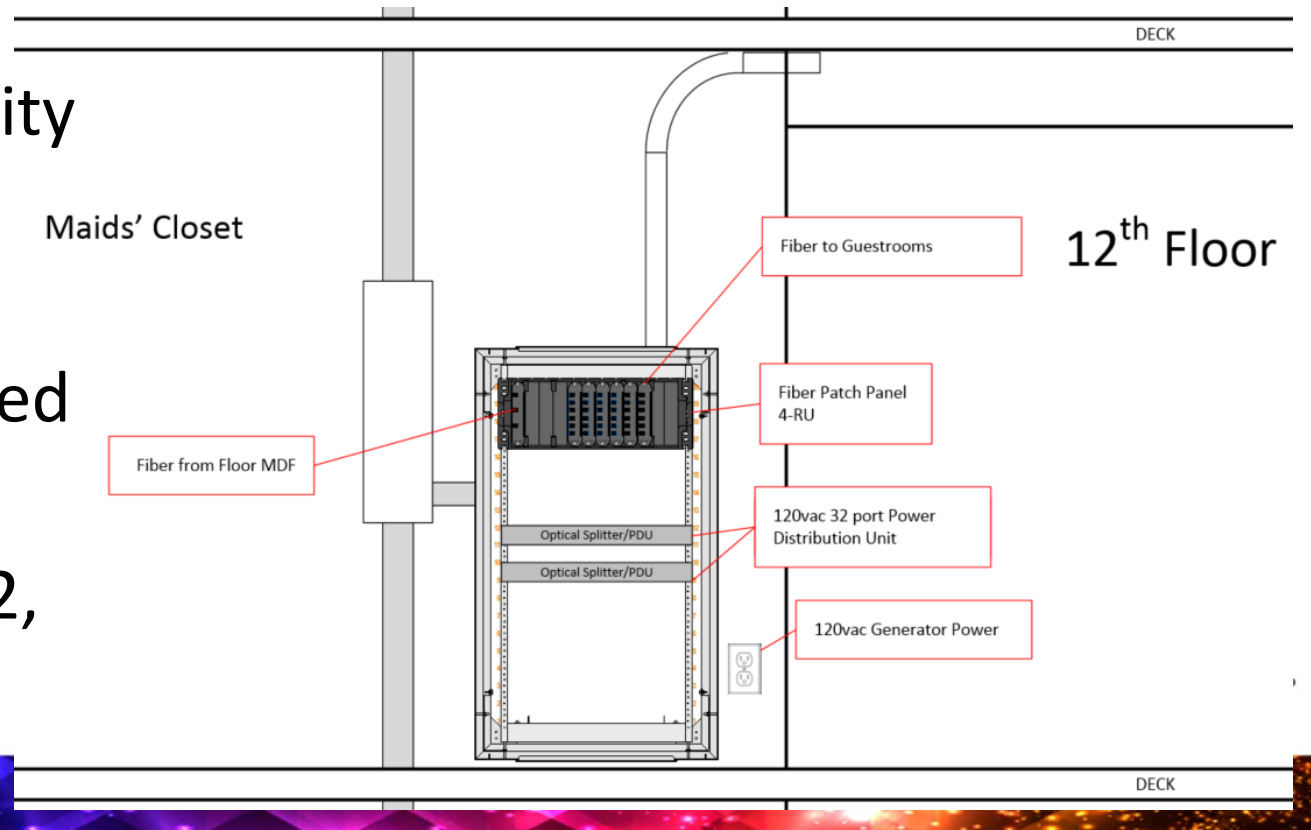

Riser

- Fiber and remote power not originating from same IDFs
- 48vdc Distributed Remote Power
- Not able to use composite cable

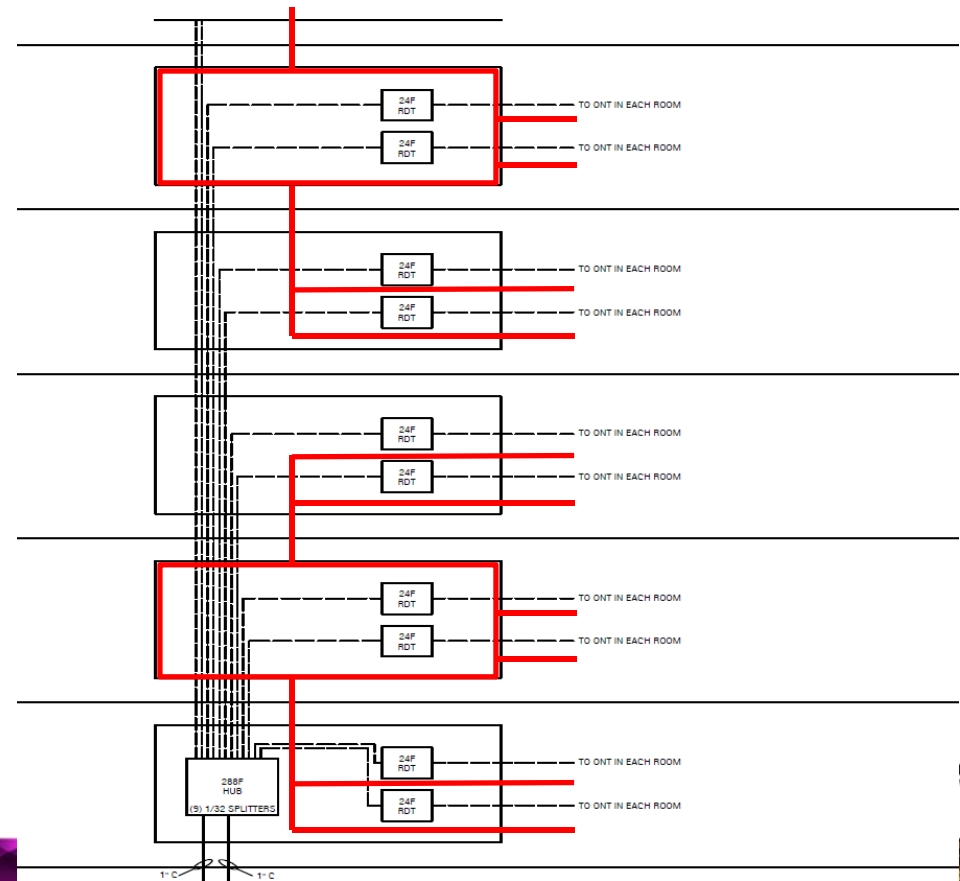

Deployment Methodologies

- Is power survivability really needed everywhere?
- Hybrid approach: use it where you need it.
- Maintain flexibility in your network.



Knowledge Check



Does a 48VDC remote power system fed by an AC plug in a TR require a licensed electrician for installation?

A. Yes

✓ B. No

C. Sometimes



Does a 48VDC remote power system fed by a 48VDC source in a MTR require a licensed electrician for installation?

✓ A. Yes

B. No

C. Sometimes



Questions?

Power Survivability
Chad Hines, ITConnect Inc.

Bicsi



90 Minute Lunch Break



Please respect others and return on time.

Bicsi



POL Testing Considerations



Sean Kelly, RCDD

Bicsi



Fiber Connectors

SC/APC is default standard in PON networks

- APC connectors reduce reflectance
- Reduce damage to transmitters and amplifiers
- Allow injection of Analog Video



APC and UPC

- Ultra Physical Contact Connectors (UPC)

- Blue



- Angled Physical Connectors (APC)

- Green



BICSI



Endface Comparison

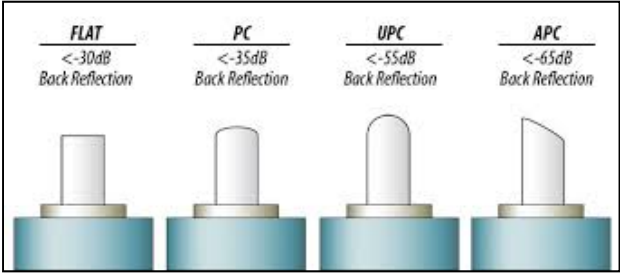
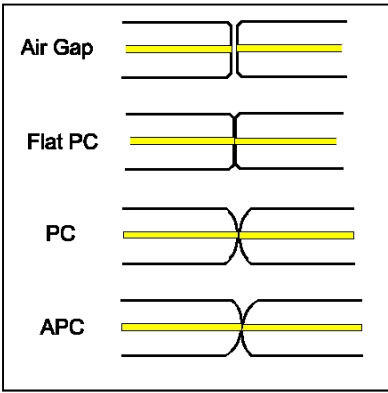
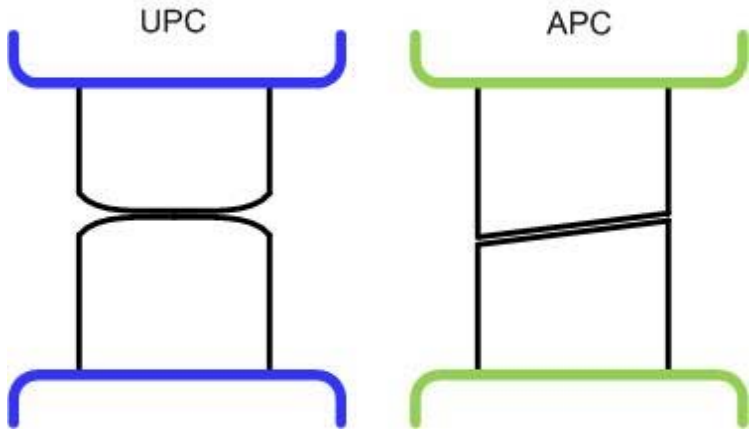

Source: FOA.ORG



APC vs. PC (un-mated)

RL = ~14.7dB

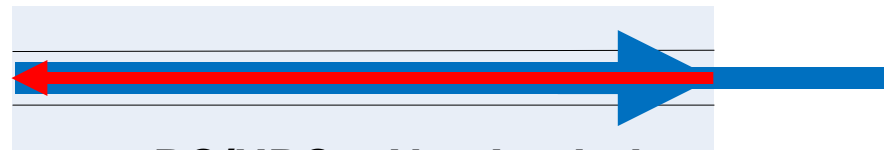

PC/UPC – Not Angled



RL = Return Loss

RL = >60dB

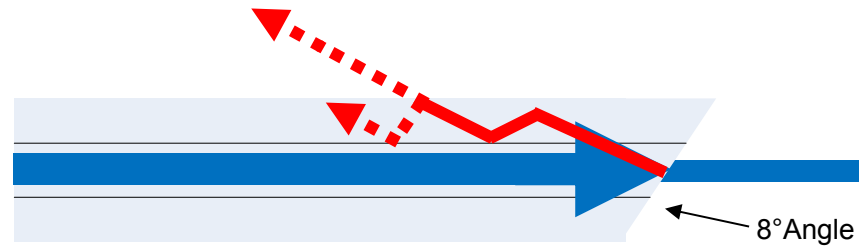

APC - Angled



APC vs. PC (mated)

RL = ~ 50-55dB

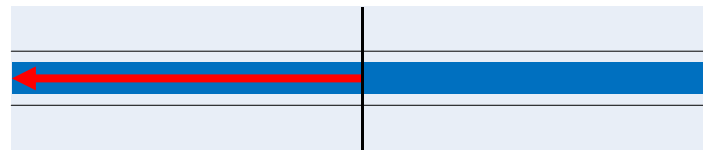

PC/UPC – Not Angled



RL = Return Loss

RL = >60dB

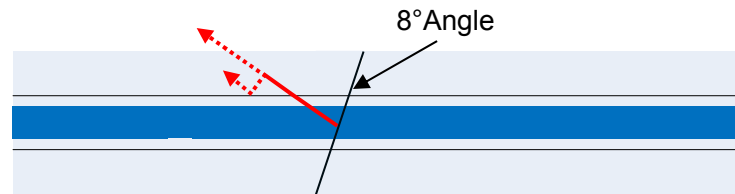

APC - Angled



Importance of Cleaning

No. 1 cause of fiber network failures is contaminated connectors

- NTT-Advanced Technology Research, 2010

80% of network problems are due to dirty connectors!

Bicsi



Importance of Cleaning

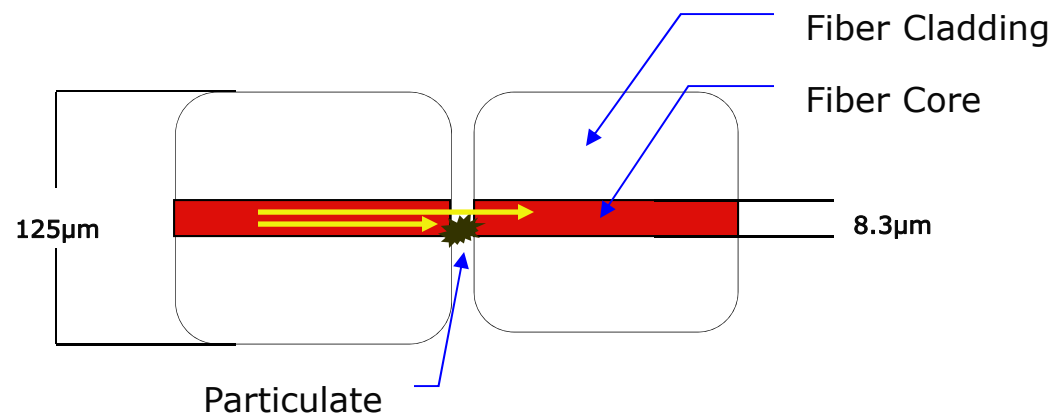

Information courtesy of USCONEC, Hickory, NC. Used with permission.

Bicsi



Common Contaminants

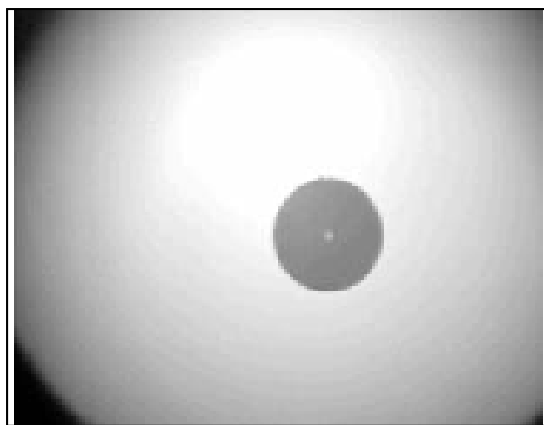

SINGLEMODE FIBER

End face should be free of any contamination or defects,

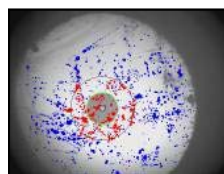

Dust Particles

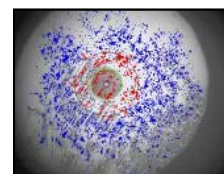

Hand Lotion

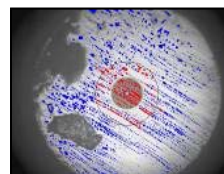

Finger Prints

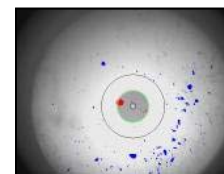

Alcohol Residue

- Dust
- Skin oil
- Alcohol residue
- Distilled water residue
- Vegetable oil
- Hand lotion
- Dryer lint
- Saltwater residue
- Graphite



Information courtesy of USCONEC and EXFO. Used with permission.

Contaminate Transfers

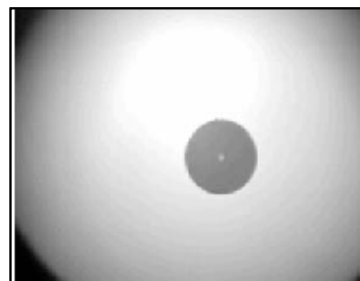

Clean ferrule

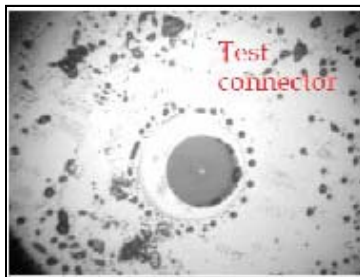

Contaminated ferrule

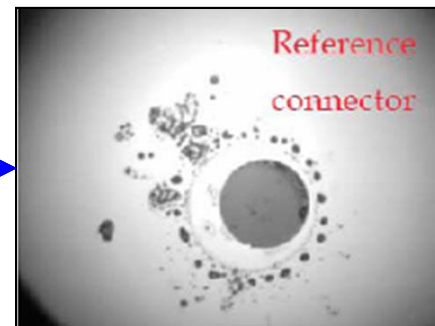

Contamination transfers from the contaminated to the clean ferrule reducing optical performance.

Information courtesy of USCONEC, Hickory, NC. Used with permission.



And Migrates

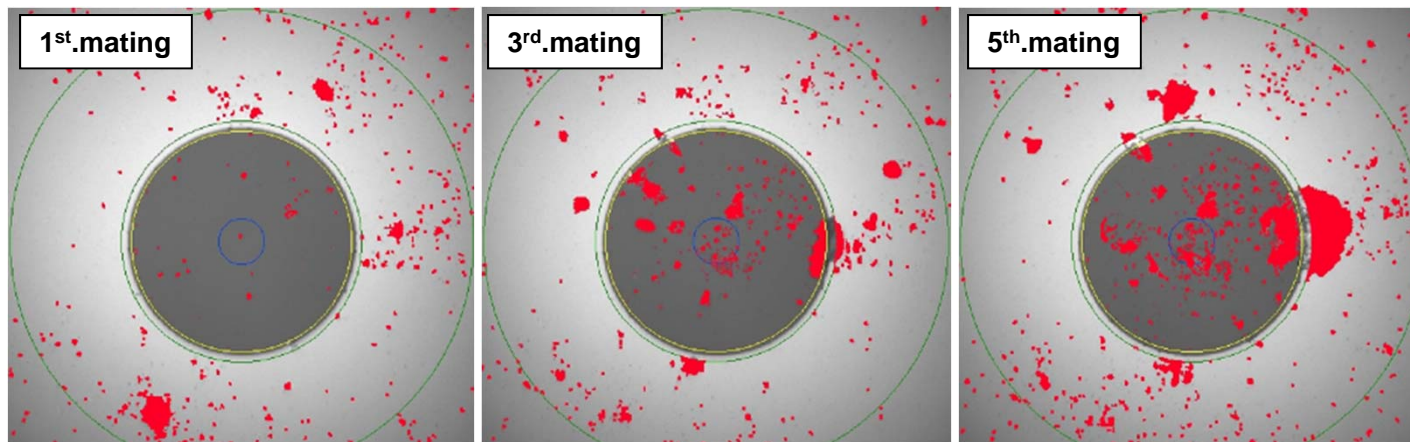

Dirt on connectors moves to the middle of the ferrule!!!

Source: IEC standard committee

Bicsi



Testing

- Key is to verify cable plant performance and connectivity
- Splitters are passive, usually trouble free
- Look for issues at connectors and jumpers
- Be aware if disconnecting before a splitter, a number of users on the channel will lose service



Testing

- Test in one direction. Light source at the OLT and power meter at the ONT locations.
- Ideally use a PON specific Light Source/Power Meter set to test 1310/1490/1550nm
- An alternate option is to use a standard Light Source/Power Meter at 1310nm and 1550nm
- OTDRs can be used for troubleshooting faults found in power meter testing, but are not used to certify links



Testing

- Testing with splitters: 3dB loss for each 1:2 split (excludes connections)
- ANSI/TIA 568C.3 = max .75dB per mated pair
- Singlemode cable = 0.5dB/km
- Bend insensitive cable can be helpful



Optical LAN Link Budget

- Max distance limited by attenuation, fiber loss. Splitters and connections contribute.
- Most budgets between 15.5 & 28dB; smaller splits and shorter cables require attenuators

Loss Contributor	GPON Budget
Splitter (1:32) =	16.7dB
Fiber Loss 10Km=	5dB
Conn/Splice Loss=	<u>3.6dB</u>
	25.3dB

Attenuation	Loss (Maximum)	Unit
Optical Loss 1310 nm	0.5	dB/Km
Optical Loss 1490 nm	0.5	dB/Km
Optical Loss 1550 nm	0.5	dB/Km
Splice Loss per unit	0.3	dB
Connector Loss	0.75	dB
1x32 PON Splitter	16.7	dB
1x16 PON Splitter	13.5	dB
1x8 PON Splitter	10.3	dB
1x4 PON Splitter	7.2	dB

Centralized Split Test Layout (Downstream)

- Measure at 1310nm/1550nm
- Document admin/labeling scheme
- Less than 23dB = Pass* (at points ② or ③)
- Paths on the same splitter should be uniform in loss

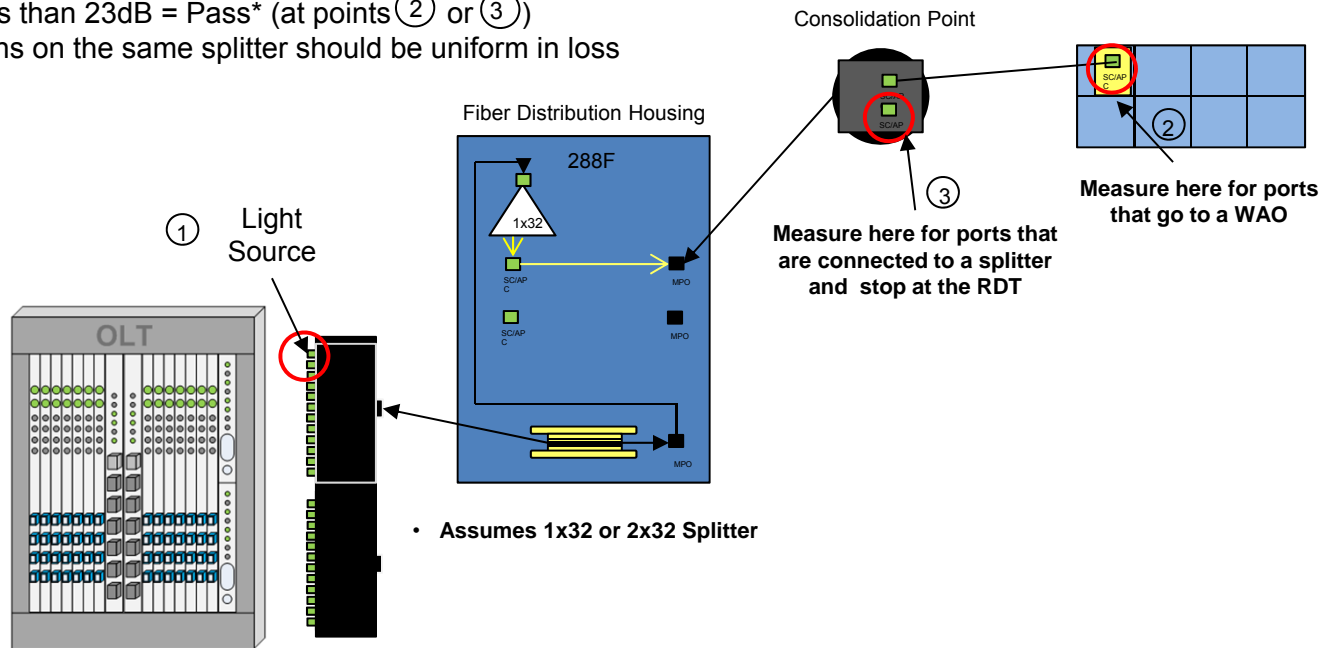

Zone Split Test Layout (Downstream)

- Measure at 1310nm/1550nm
- Document admin/labeling scheme
- Less than 20dB = Pass* (at points ② or ③)
- Paths on the same splitter should be uniform in loss

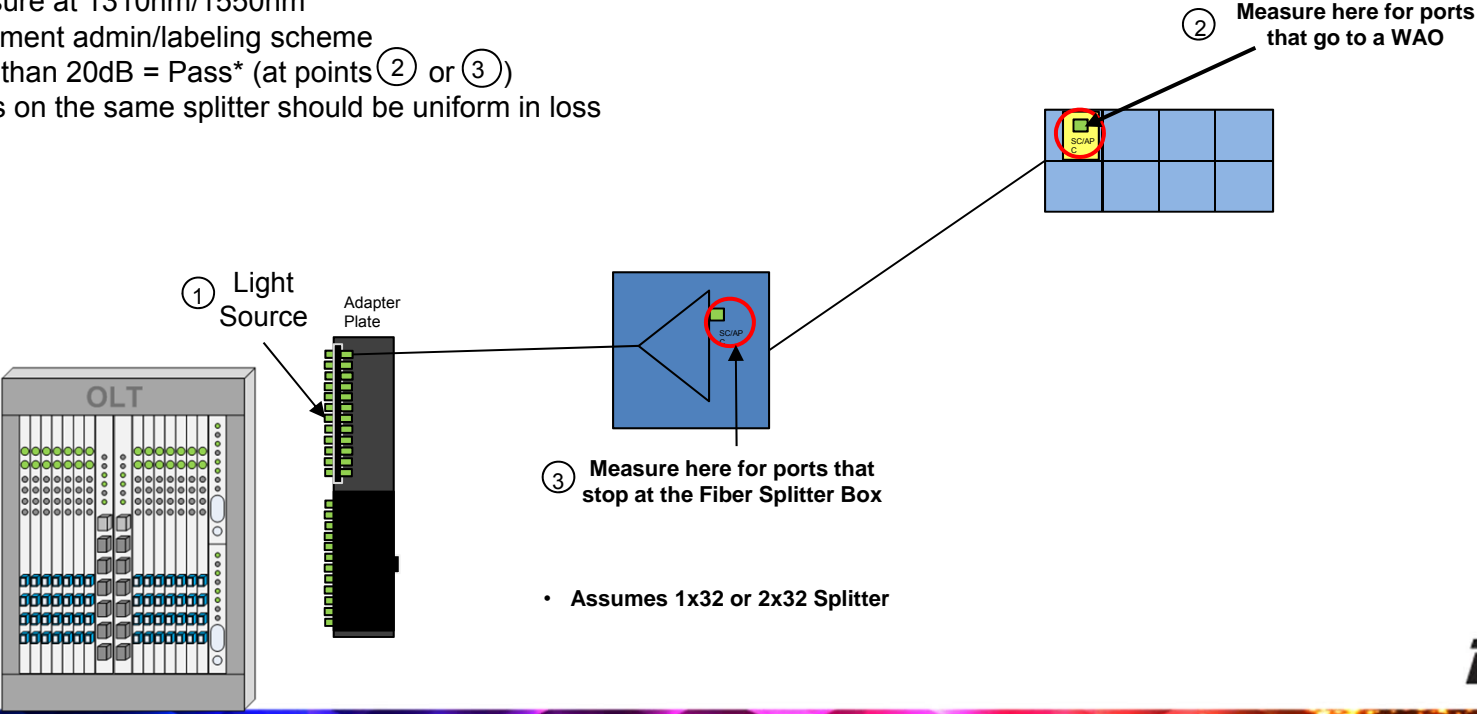

Zone Split (Cascaded) Test Layout (Downstream)

- Measure at 1310nm/1550nm
- Document admin/labeling scheme
- Less than 21.5dB = Pass* (at points ② or ③)
- Paths on the same splitter should be uniform in loss

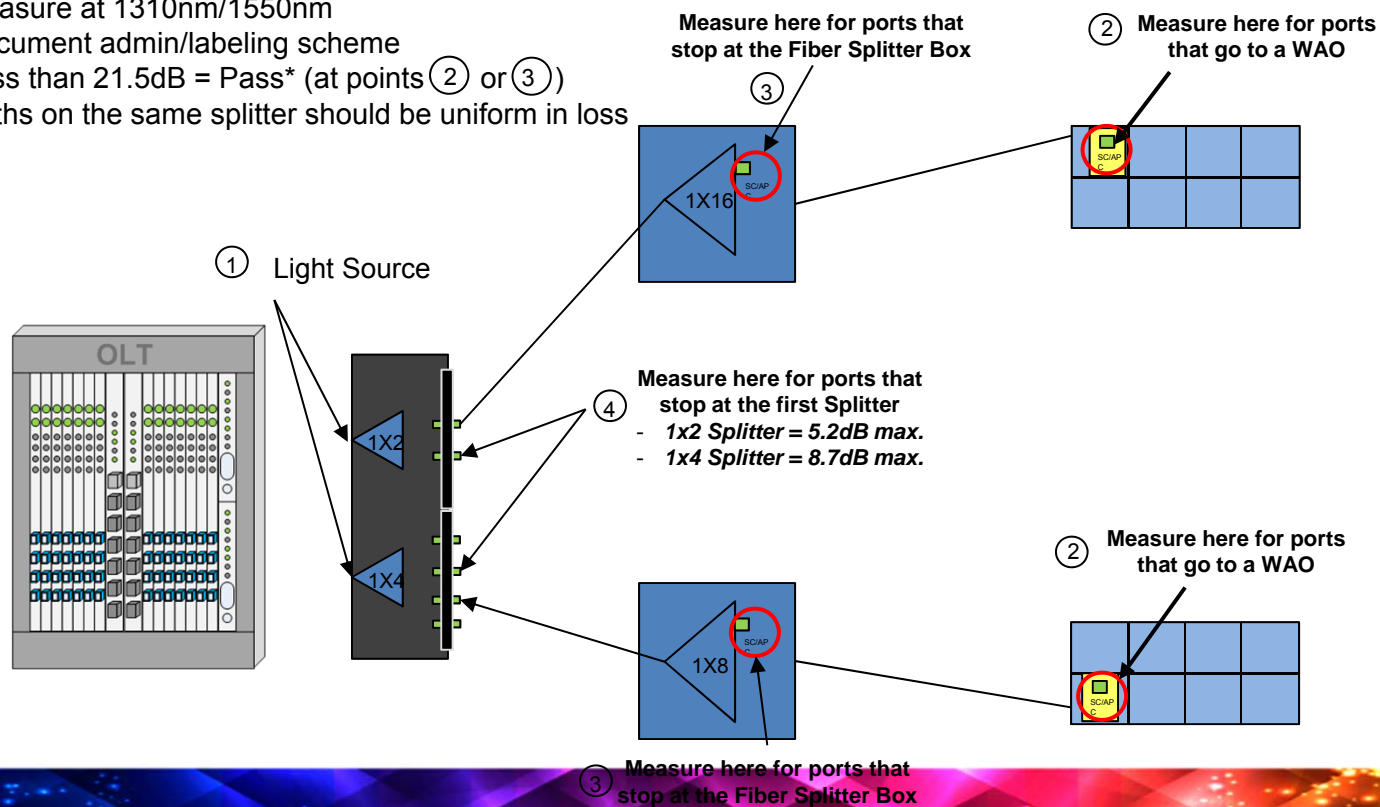

Rack Mount Split Test Layout (Downstream)

- Measure at 1310nm/1550nm
- Document admin/labeling scheme
- Less than 19.75dB = Pass* (at points ② or ③)
- Paths on the same splitter should be uniform in loss

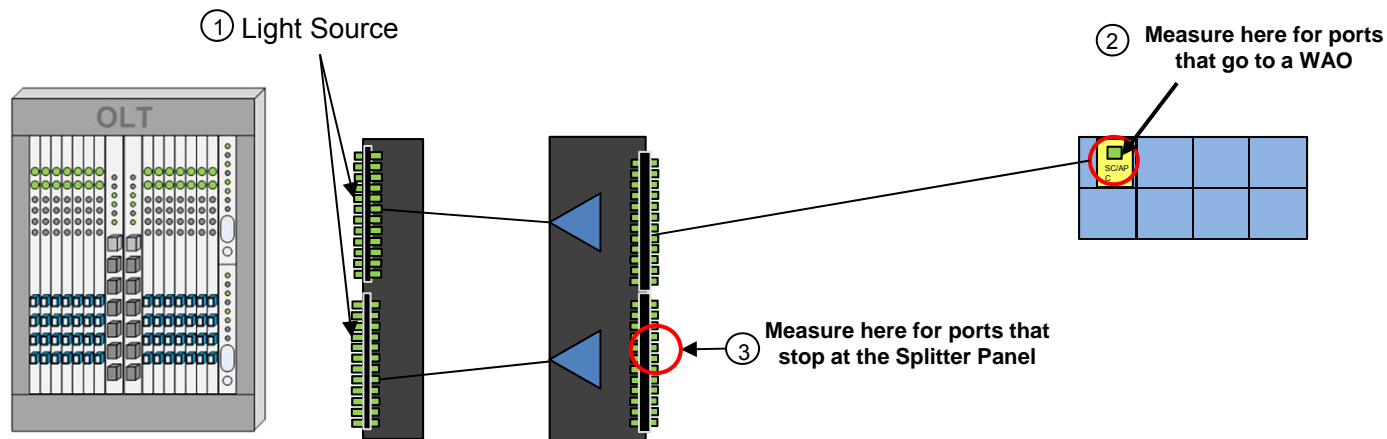

• Assumes 1x32 or 2x32 Splitter



Hybrid PON/Traditional Test Layout (Downstream/Upstream)

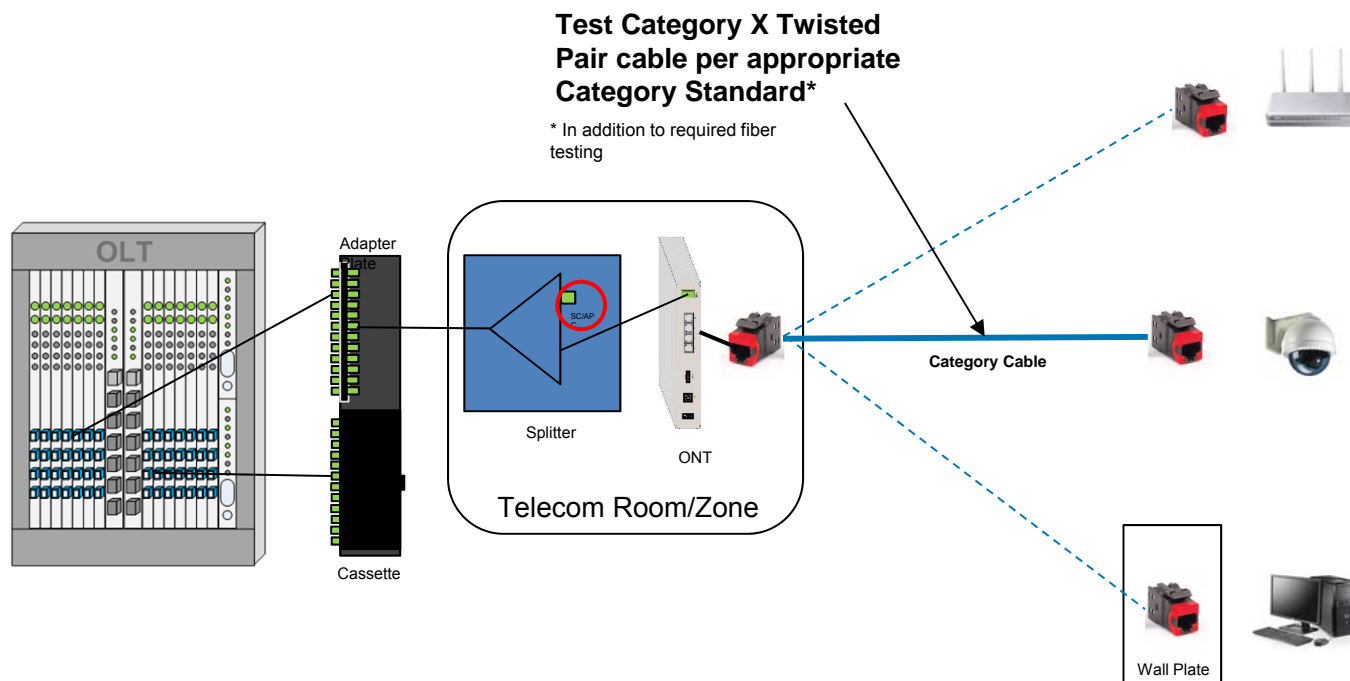

Move, Add, Change (MAC) Testing

Once the splitter input is connection is made to the OLT, it cannot be disconnected for testing of MACs without disruption to the other users. When a move, add, or change is made on an active PON circuit, verification must be made to ensure that the proper range of power in dBm will be fed to the ONT. There is a minimum and a maximum value that is acceptable per ITU G.984X. This is verified by placing the connector that will connect to the input of the ONT into an Optical Power Meter and measuring the power in dBm to verify that it is between the minimum and maximum level.

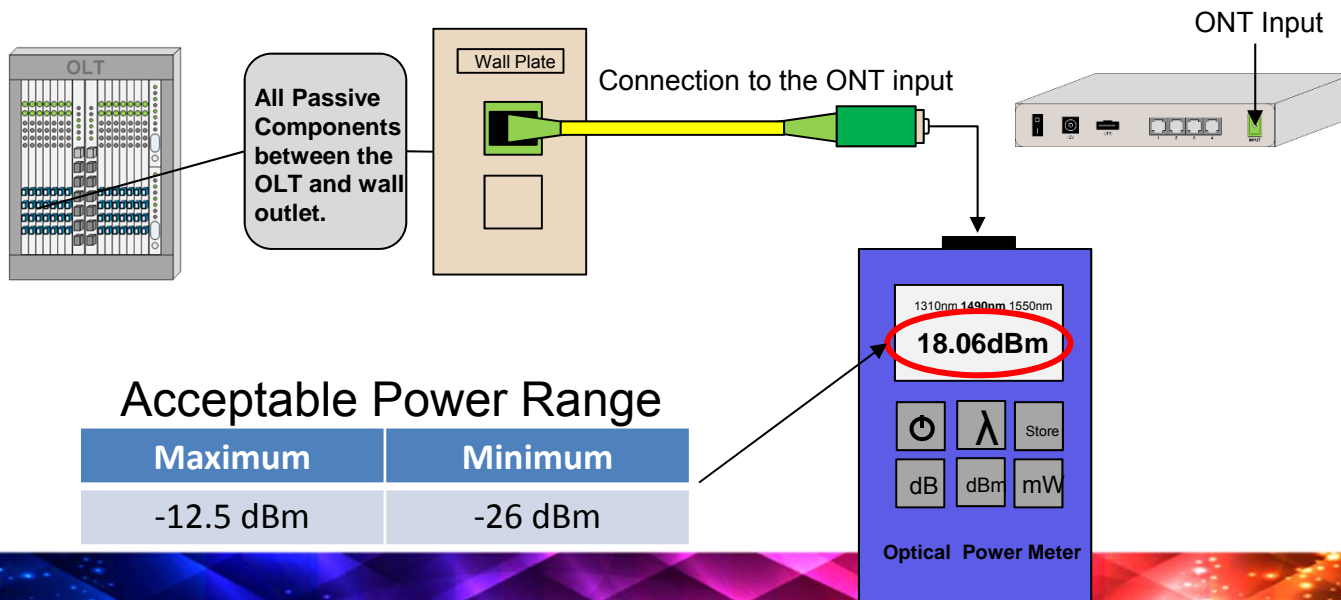

Referencing the meter

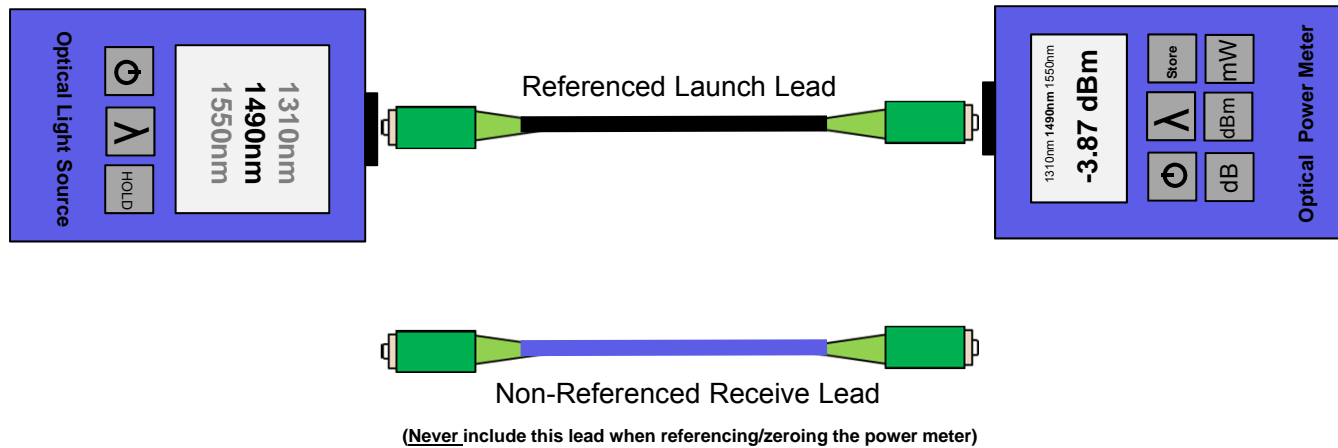

Link Test with WAO

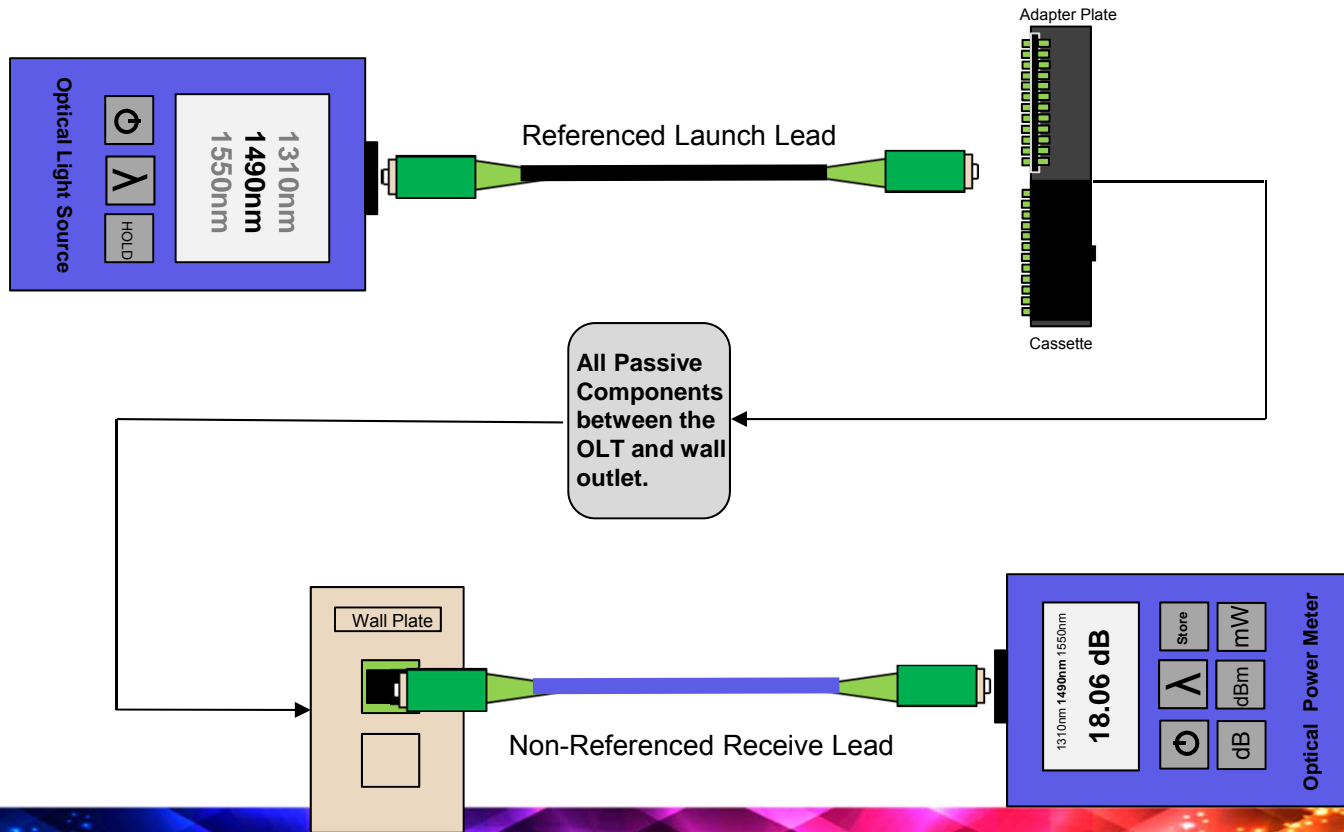

Poke Through

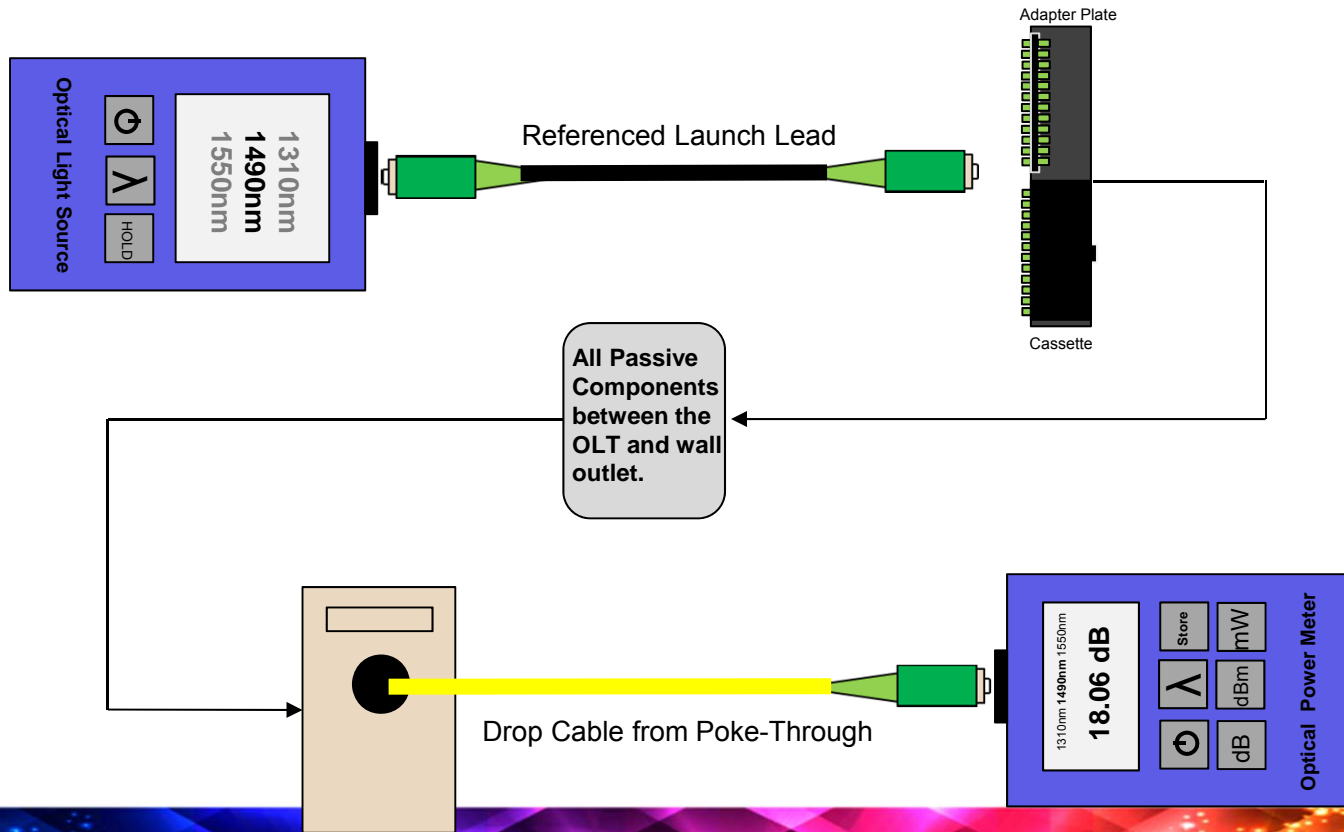

Mid-Point Verification

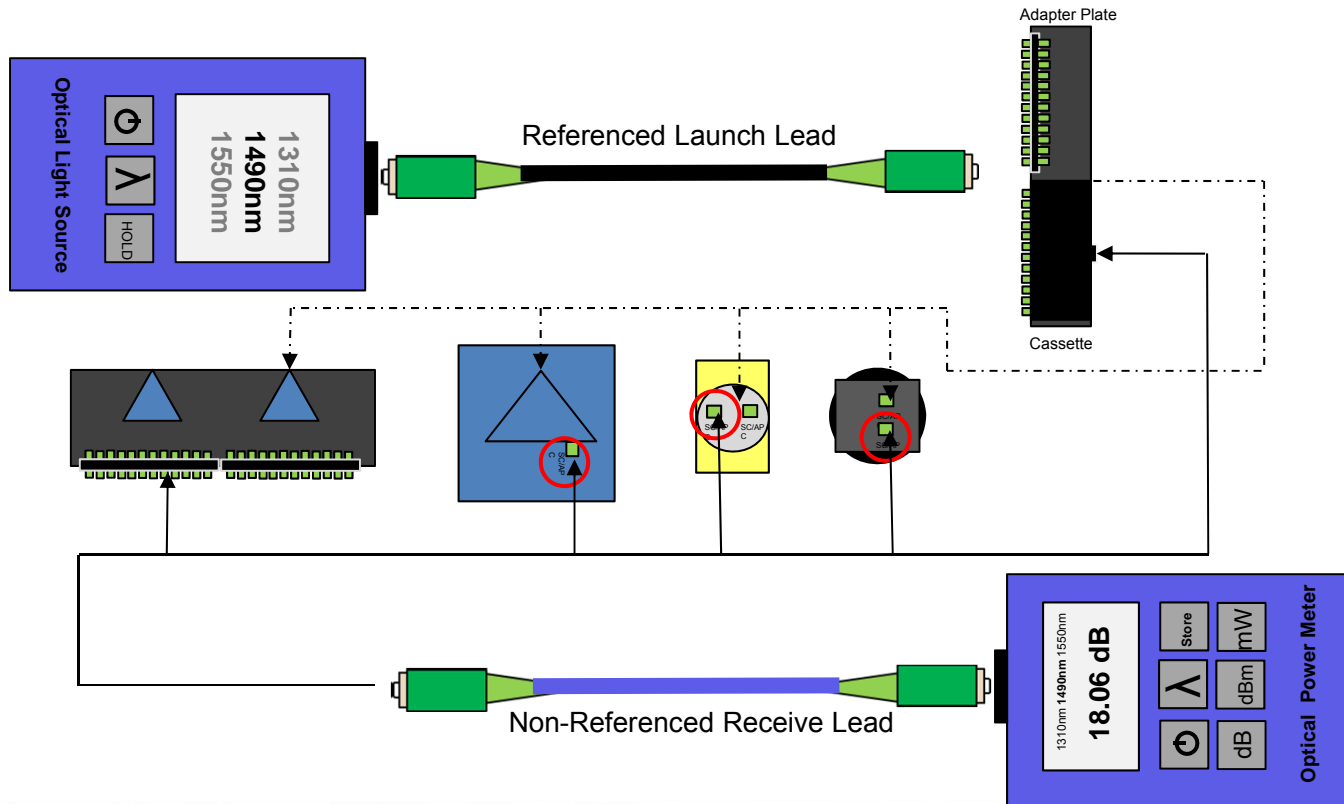

Knowledge Check



This is the common POL connector

- ✓ A. SC/APC
- B. ST
- C. MT-RJ
- D. FC



POL Networks use this fiber...

- A. Multimode
- ✓ B. Singlemode
- C. Unimode
- D. OM3



It is important to ensure connector endfaces are clean prior to mating

- ✓ A. True
- B. False



Contaminate on fiber connectors can

A. Transfer

B. Migrate

C. Block light

✓ D. All of the above



You should always use a wet cleaning method to remove contamination

A. True

✓ B. False



A reduction of 3dB of light signal reduces the received power by...

A. 10%

✓ B. Half

C. 12 Volts



When testing a POL with an OTDR, you should test in this direction...

- A. Upstream
- B. Downstream
- C. Sideways



Loss budgets should be determined by advertised
“Typical” performance values

A. True

✓ B. False



Questions?

POL Testing Considerations

Sean Kelly, RCDD



Passive Optical LAN Integration & Management



Matt Miller

Sr. Solutions Architect, CallisonRTKL

Bicsi



Agenda

- PON Communications
- ONT Ranging Process
- RF Video Injection
- Centralized Administration
 - Management Server vs CLI
- Templates & Profiles
- VLAN Creation
- Uplink Provisioning
 - Link Aggregation Groups
- ONT Deployment & Discovery
- ONT Provisioning
 - FSAN Type B Protection
- Bandwidth Calculations & Assignment
- Traffic Flow
- Tagging, LLDP, PoE, QoS
- STP & Loop Detection
- Multicast



Objectives

After successfully completing this course, you should be able to:

- Understand the differences between ITU and IEEE PON Standards
- Describe the ONT ranging and provisioning process
- Understand the basic steps for deploying a POL
- Understand the future PON standards



PON in Detail - Overview

Passive Optical Networks (PON) are standards-based communication architectures. There are literally tens of millions of subscribers utilizing PON for voice, video and data service (known as "triple play" service). PON networks rely on wave division multiplexing (WDM) and lasers to provide triple play services in an efficient and future proof service offering.

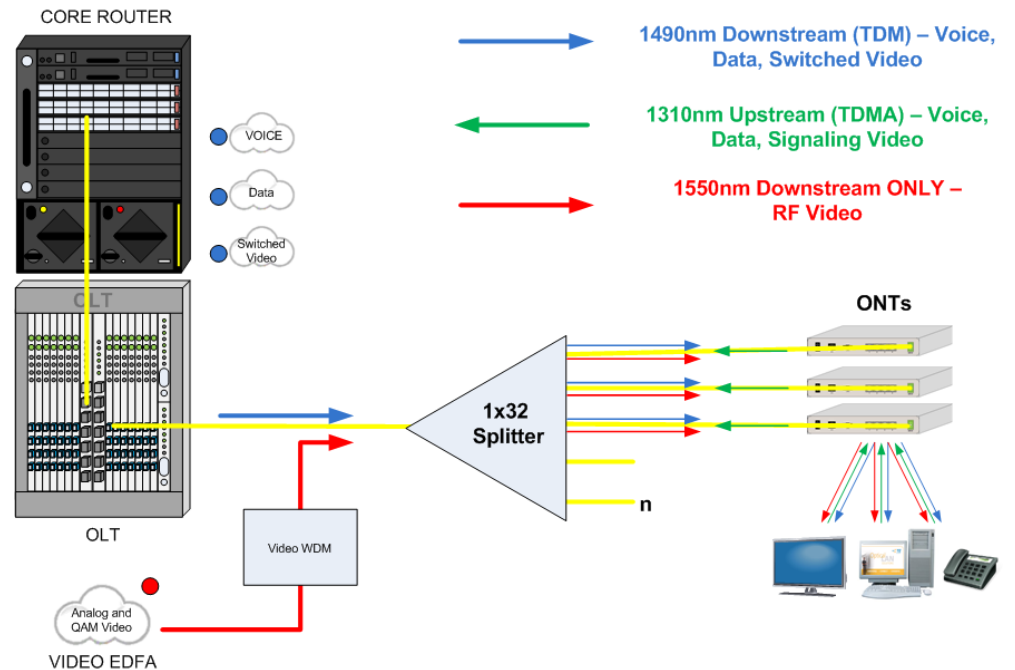

Standards – IEEE vs. ITU

- ITU and IEEE have separate standards for PON
- Both standards use the same passive infrastructure (fiber & splitters)
- The primary difference is the electronics



Popular Standards Comparison

	EPON	GPON
Standard	IEEE 802.3ah	ITU G.984
Speed	1Gbps Symmetrical	2.4Gbps Down / 1.2 Gbps Up
Framing	Ethernet (mostly native)	GEMS Encapsulation
Wavelengths	1490nm/1310nm	1490nm/1310nm
Dynamic Bandwidth	Optional Vendor Specific	Built-in
Encryption	Optional Vendor Specific	AES-128 Downstream

Standards Timeline

IEEE

ITU

	1995	1995 – APON Standard Introduced (155M)
	1996	
	1997	
	1998	
	1999	1999 – BPON Standard Approved (622M/155M)
	2000	
	2001	
	2002	
2004 – EPON Standard Approved (1G)	2003	2003 – GPON Standard Approved (2.4G/1.2G)
	2004	
	2005	
	2006	
	2007	
2009 – 10G EPON Standard Approved (10G)	2008	
	2009	
	2010	2010 – XGPON1 Standard Approved (10G/2.5G)
	2011	
2012 – Extended EPON Task Force Formed	2012	
	2013	2013 – NGPON2 (40G TWDM)
	2014	

WDM Methodology

- Multiple wavelengths over the same physical strand of glass
- Wavelengths do not interfere with each other
- Allows multiple discreet communications

wavelength-division multiplexing (WDM)

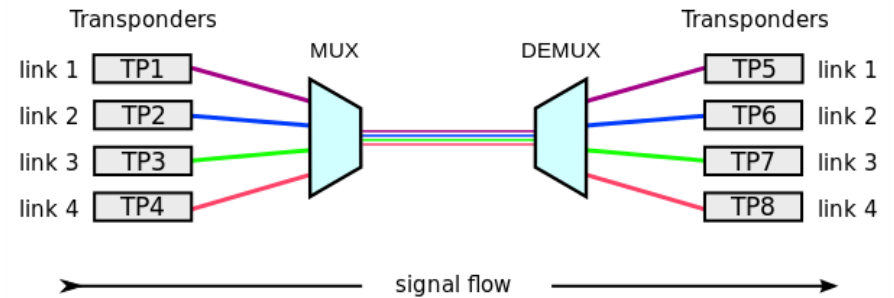

"WDM operating principle" by Xens - Own work. Licensed under Creative Commons Attribution-Share Alike 3.0 via Wikimedia Commons - http://commons.wikimedia.org/wiki/File:WDM_operating_principle.svg#mediaviewer/File:WDM_operating_principle.svg



WDM in PON

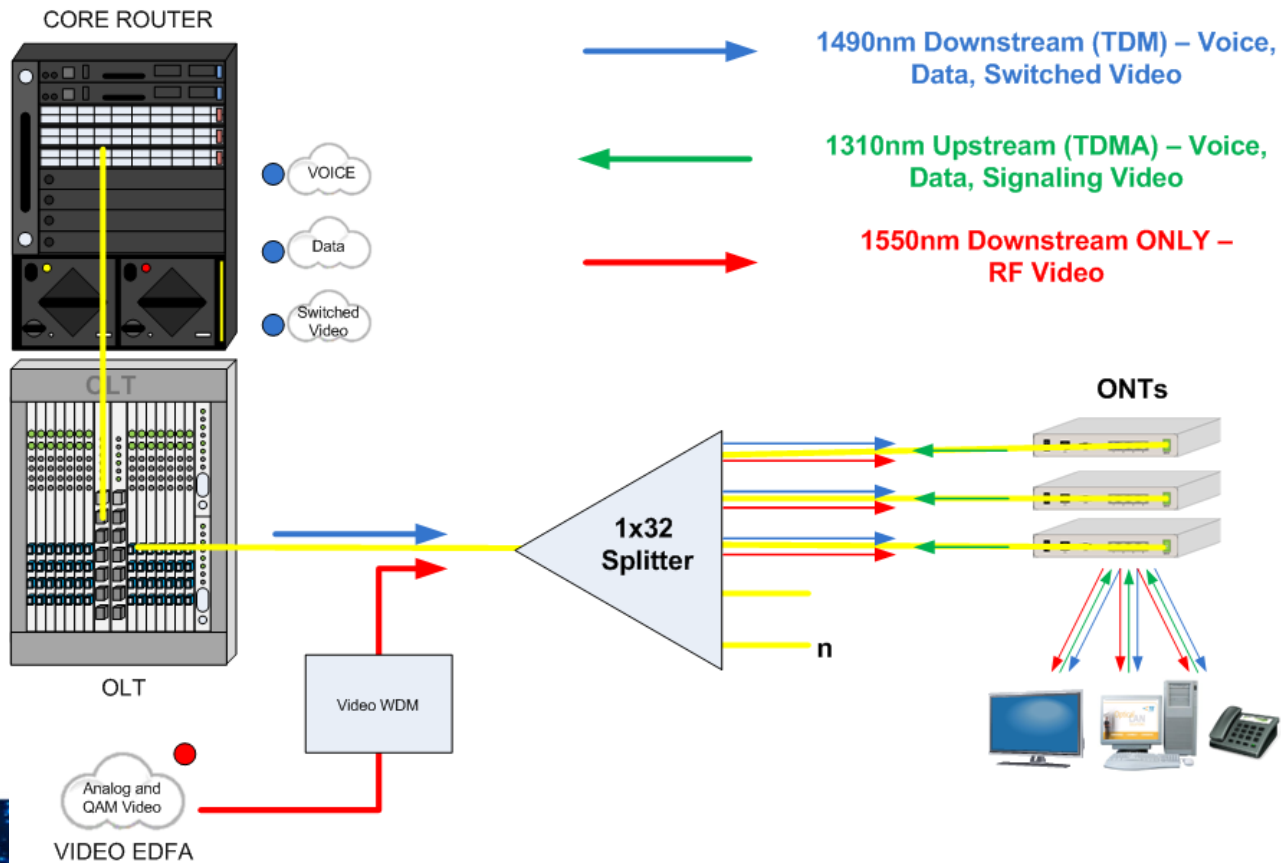

PON Types

- **BPON – (Broadband PON)** is an older version of PON technology which is based on ITU specifications and is characterized by an asymmetrical 622 Mbps downstream and a 155 Mbps upstream optical line rate. Earlier versions of Verizon's FiOS™ offering in the U.S. are based on BPON but more recent implementations of FiOS use GPON technology.
- **GPON – (Gigabit PON)** is the latest ITU specified PON network and is characterized by a 2.4 Gbps downstream and a 1.25 Gbps upstream optical line rate. The first significant commercial deployments of GPON began in early 2008. Most carrier implementations of GPON are in the U.S. however it is beginning to proliferate in European markets as well.
- **EPON – (Gigabit Ethernet PON or GEAPON)** is an IEEE standards based PON system characterized by a symmetrical 1.25 Gbps optical line rate. EPON is the predominant PON solution since it has been commercially available since 2001. GEAPON has been primarily deployed in Asian Pacific markets. Recently, 10Gbit/s EPON or 10G-EPON was ratified as an amendment (IEEE 802.3av) in the IEEE 802.3 standard and provides for an asymmetrical 10 Gbps downstream/1 Gbps upstream rate as well as a symmetrical 10 Gbps rate.
- **WDM PON – (Wave Division Multiplexing PON)** is an emerging technology which leverages the optical advances of dense wave division multiplexing (DWDM) to provide a dedicated wavelength to a single ONT. Implementations range from “tunable” optics which must be matched to the ONT's optics to a dynamic optical locking capability which automatically assigns a wavelength to the ONT at the ranging phase. WDM PONs utilize an arrayed waveguide grating (AWG) to multiplex up to 32 wavelengths of light onto a single fiber in the same way a passive optical splitter does. Unlike a typical optical splitter however, an AWG utilizes a phase shift in the optical light to provide an output on each fiber that only receives a certain wavelength of light.



Downstream Communication

The OLT transmits a signal downstream that all of the ONTs receive (point-to-multipoint). In the downstream direction, the information is broadcast on a specific color (wavelength) of laser light. The information is encoded into digital form and given a specific address that matches a specific ONT. The ONT that matches the address receives the signal and forwards the information to the end-user Ethernet port as depicted below.

Downstream Broadcast

All data goes to all ONTs and the ONT address controls the output data

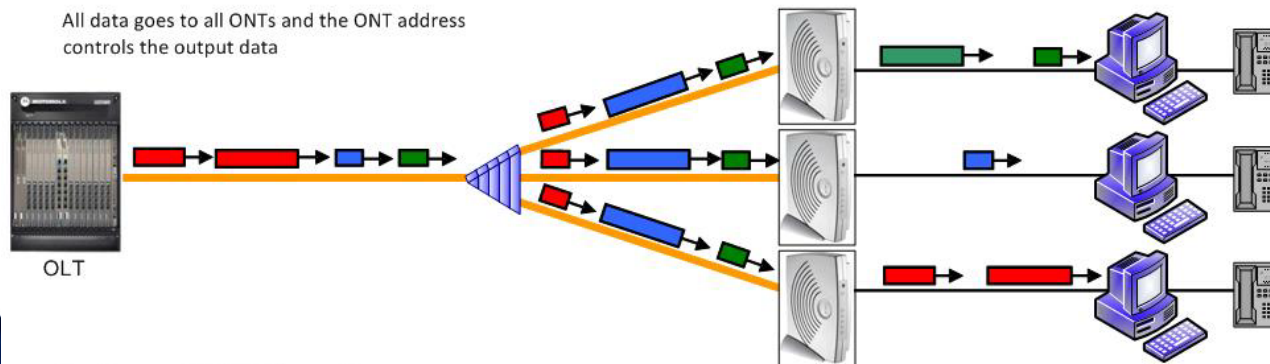

Upstream Communication

Since many ONTs are placed on the same fiber, each with their own laser, upstream communications must be coordinated so that they do not interfere with each other. This is done by synchronizing the ONTs and requiring each to send information to the OLT (Upstream) in a specific time window (TDM). The upstream laser color is different from the downstream laser, so the upstream signal will not interfere with other ONTs on the PON. Using the WDM technique, ONTs do not interfere with each other; the upstream signals do not interfere with downstream signals, and the upstream and downstream signals can communicate at the same time (full duplex). This mechanism for converged, duplex communication is depicted below.

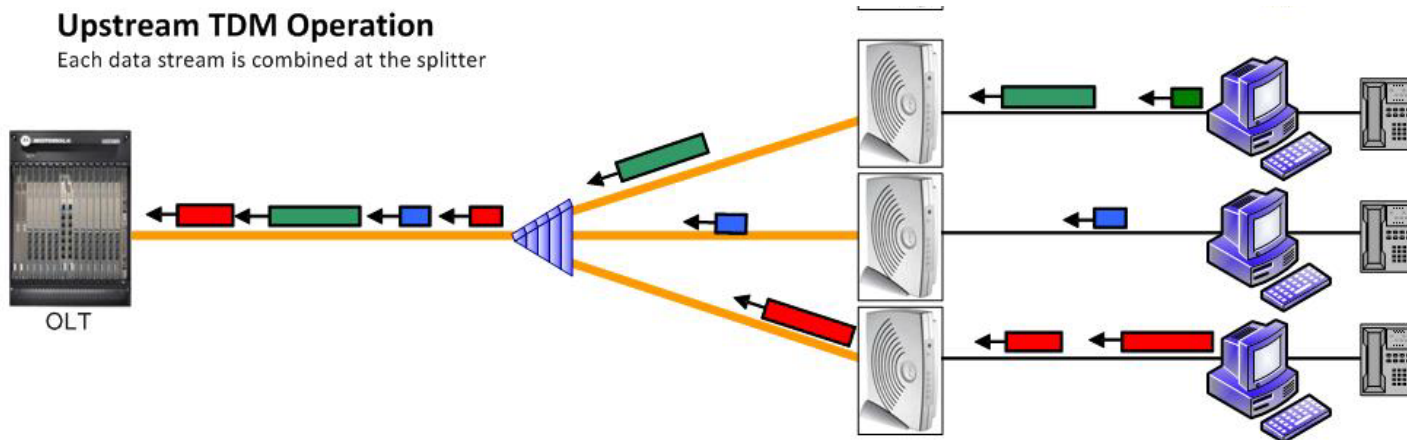

GPON Bandwidth

- GPON upstream bandwidth is directly correlated to TDMA time slot
- Each ONT will get a number of timeslots allocated. Each frame is 125 μ s in length

- Static bandwidth management
- Dynamic Bandwidth Allocation (DBA)
 - DBA is specified in ITU 984.3. This feature is used to grant upstream bandwidth to ONUs based on their demand
 - Used for oversubscribing GPON links

ONT Ranging Process

1. Authorize ONT to be on the PON
2. Determine distance from OLT
3. Setup OMCI communications
4. Assign bandwidth timeslots
5. Upgrade ONT software
6. Assign VLANs, QoS, PoE, security, etc.



RF Video

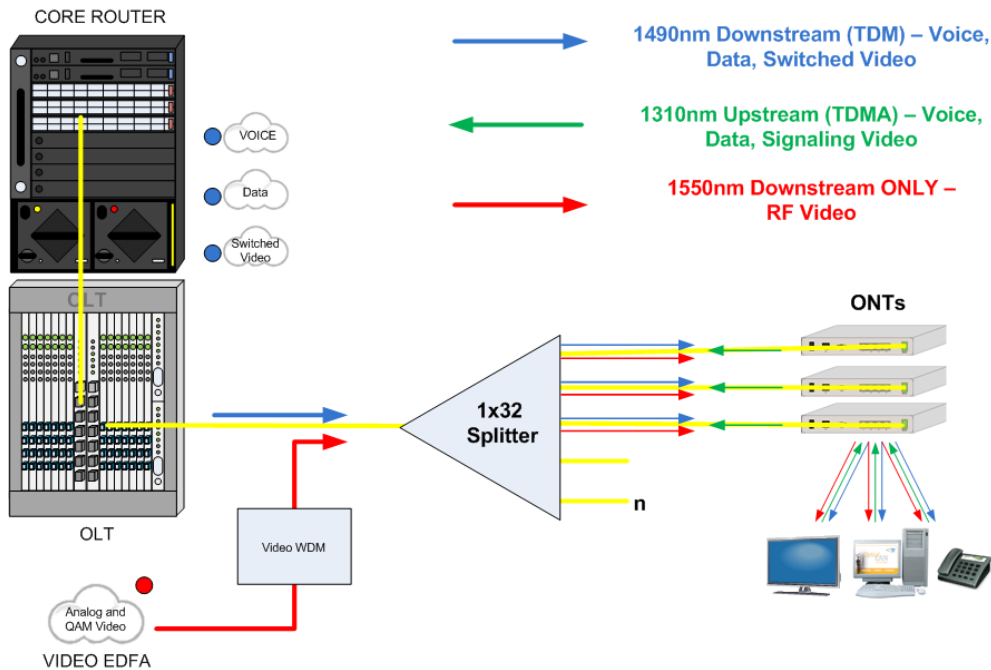

Additionally, an analog signal can be injected onto the same PON fiber, using yet another color of light (WDM techniques). This is called an overlay and is generally used to carry broadcast TV to the user's location. As with data and voice propagation, the light is a different color and therefore does not interfere with the other signals being carried on the fiber cable.



RF Video

1. Video Source (Coax)
2. Laser Transmitter
3. Erbium Doped Fiber Amplifier (EDFA)
4. WDM

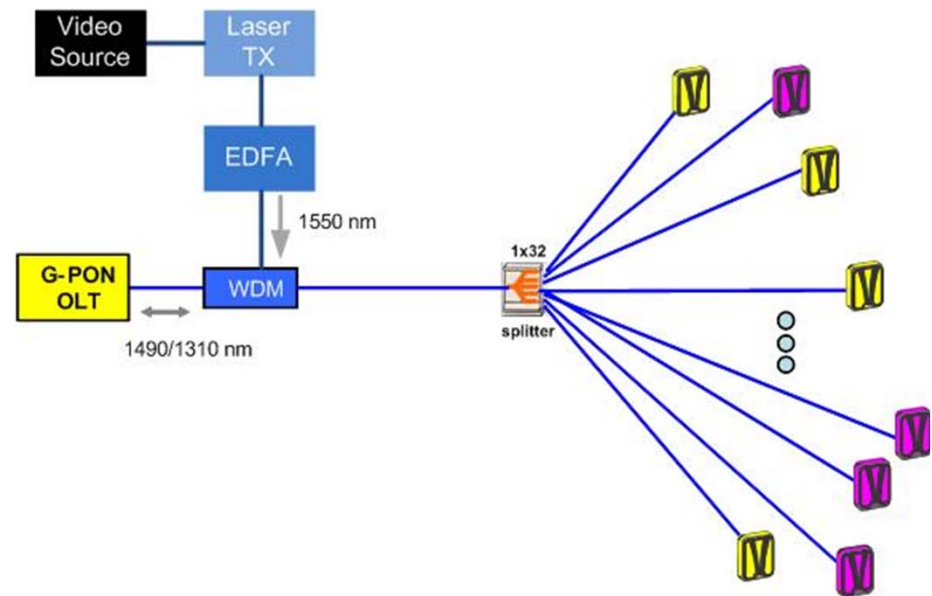

Centralized Administration

- Reduce Operations & Maintenance (O&M) by reduced the amount of equipment managed
 - ONTs are managed by the OLT
- No powered devices in the middle of the network
 - Same location as user
- Co-locate OLT with other IT gear
 - Same location as other gear
- OLT handles activation, administration, and provision
- No administration ports on ONTs



15 Minute Break



Please respect others and return on time.

Bicsi



Knowledge Check

- What is a VLAN?
- Difference between Layers 1, 2 and 3
- Have you provisioned a Cisco/Brocade/Juniper switch?



Templates & Profiles

- Templates and profiles allow admins to create common settings

The screenshot displays a network management interface. On the left, a tree view shows a network hierarchy: Network > Test-Lab > 1134 MSAP > 01 4xGPON > 02 4xGPON > 01 PON > 01 Test-Lab > 02 PON > 03 PON > 04 PON > 03 4xGPON > 04 4xGPON > 05 4xGPON. The main window shows the 'Ports' configuration for the 'Voice' tab. A table lists port configurations with columns for AID, User Label, Port Profile, IGMP, PoE, RSTP, PAE, NAC, LLDP, Admin State, and Status. A configuration dialog box is open over the table, titled 'Identity', with fields for Name (Spon Traffic Profile), Parent Name (core-olt (192.168.50.22 : MXK-3U)), and Parent Type (Mx3U_Device). Below these are various profile settings like Profile Index, Traffic Class, and bandwidth allocation options.

AID	User Label	Port Profile	IGMP	PoE	RSTP	PAE	NAC	LLDP	Admin State	Status
ETH1-2-1-1-1		default	default	PoE_Enabled	BPDU_Guard	default	Data_VoIP-200_250	LLDP_Enabled	Enabled	Modified
ETH1-2-1-1-2		default	default	default	default	default	default	default	Disabled	
ETH1-2-1-1-3		default	default	default	default	default	default	default	Disabled	
ETH1-2-1-1-4		default	default	default	default	default	default	default	Disabled	



VLAN Creation

- POL uses VLANs just like Ethernet switches

VLAN Property							
Start	End	Count	ACL Mode	Bridge Type	MST ID	Registration Type	Description
300	300	1	Disable All ACLs	Full Bridging	CIST	Dynamic	CloudVLAN300
302	302	1	Disable All ACLs	Full Bridging	CIST	Dynamic	CloudVLAN302
304	304	1	Disable All ACLs	Full Bridging	CIST	Dynamic	CloudVLAN304
306	306	1	Disable All ACLs	Full Bridging	CIST	Dynamic	CloudVLAN306
308	308	1	Disable All ACLs	Full Bridging	CIST	Dynamic	MGMT
2001	2005	5	Disable All ACLs	Full Bridging	CIST	Dynamic	TIP_VLANS

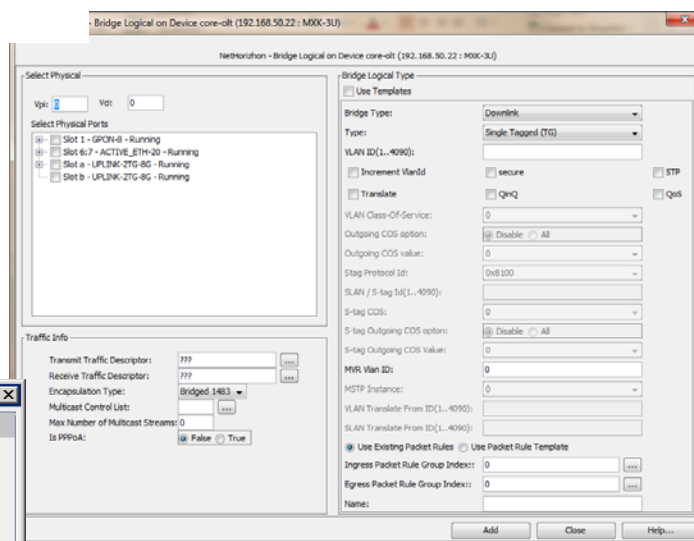

Uplink Provisioning

- Pick 1G and 10G Ethernet ports to connect to the core network

Network Interface - VLAN Association					
Start	End	Count	Interface	Force Forward	IGMP
300	300	1	NET1 (Uplink)	<input type="checkbox"/>	<input type="checkbox"/>
302	302	1	NET1 (Uplink)	<input type="checkbox"/>	<input type="checkbox"/>
304	304	1	NET1 (Uplink)	<input type="checkbox"/>	<input type="checkbox"/>
306	306	1	NET1 (Uplink)	<input type="checkbox"/>	<input type="checkbox"/>
308	308	1	NET1 (Uplink)	<input type="checkbox"/>	<input type="checkbox"/>
2001	2001	1	NET2 (Uplink)	<input type="checkbox"/>	<input checked="" type="checkbox"/>
2002	2002	1	NET2 (Uplink)	<input type="checkbox"/>	<input checked="" type="checkbox"/>
2004	2004	1	NET2 (Uplink)	<input type="checkbox"/>	<input type="checkbox"/>
					MGMT
					Network-A (ONT-1)
					Network-B
					VoIP

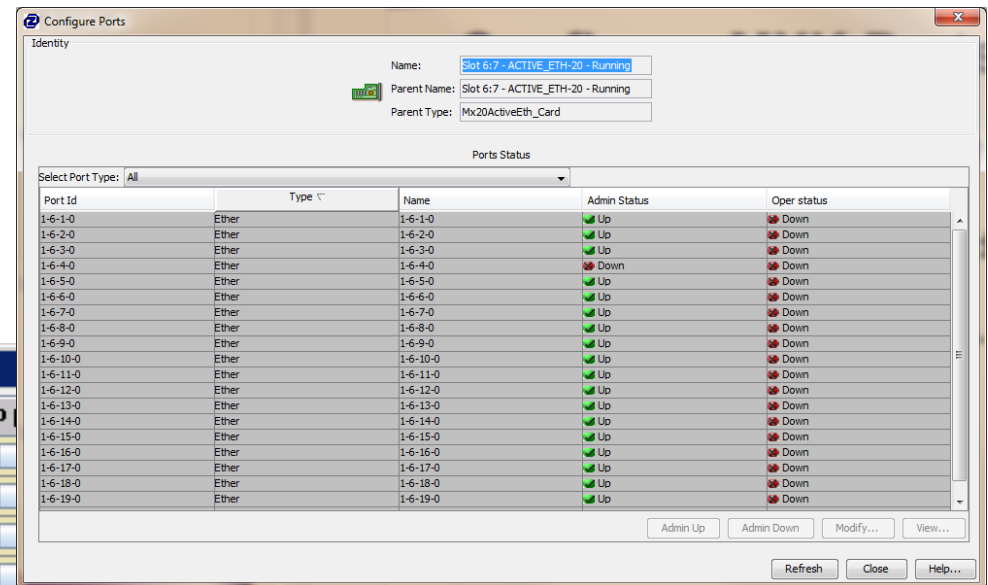

Uplink LAGs

- Add individual ports to Link Aggregation Groups
- Configure LACP

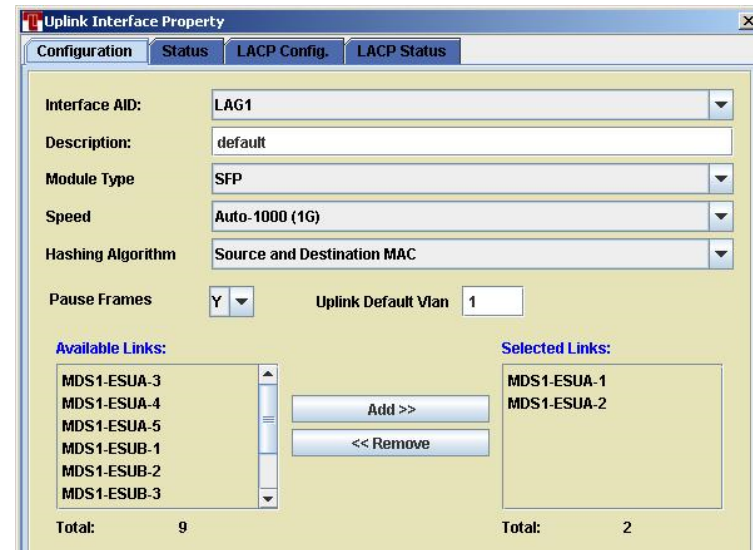

ONT Discovery

- ONTs will notify the OLT when they are connected
- Administrator determines next steps

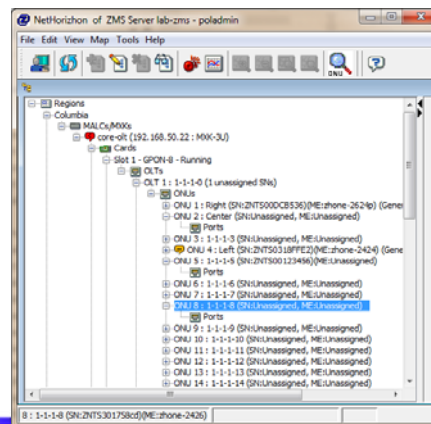
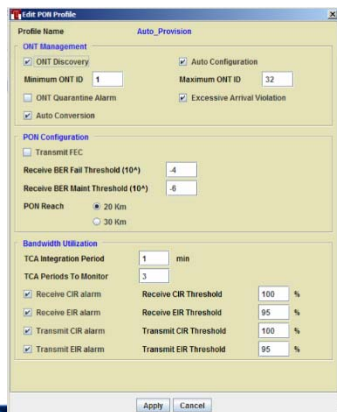

ONT Ranging

- Know your ONT locations before they are deployed
- Assign a name and location as they are ranged

The screenshot shows the 'ONT Property' configuration page. It features several tabs: Configuration, ONT Property (selected), ONT Status, Power, Advanced, and Certificate Status. The main content area is divided into sections for various parameters:

- NE IP Address:** 192.168.1.97
- NE Target Identifier:** Test-Lab
- Port AID:** MDS1-2-1
- ONT AID:** MDS1-2-1-1
- ONT ID:** 1
- Serial Number:** CIGGA1822971 (selected with a radio button)
- Registration ID:** 0000000000 (selected with a radio button)
- Upstream BER Threshold:**
 - Failure:** 4
 - Maintenance:** 6
- Registration Status:** Locked (with a 'Check box to unlock' checkbox)
- eStop Mode:** Off (selected with a radio button)

The screenshot shows the 'NetHorizon - Modify GponOnu Physical Configuration' dialog box. It is divided into several sections:

- Identity:** Name: 10 (Generic CPE 192.168.50.22:47013); Parent Name: OLT 1: 1-1-1-0; Parent Type: GponOlt_Physical; Device Name: core-olt (192.168.50.22 : 1)
- Template:** Template Name: GponOnu_Physic; Copy from Existing Port: ONU 1 : Right (S)
- Tree:** A tree view showing the configuration hierarchy: Quick Config, Advanced, Identity, Status, Configuration, Alarm Status, and ONU Status.
- Quick Config:** Name: Right; Append Default Name: ; Update Bridges/IPs: ; Description: right; Admin Status: Up

Buttons at the bottom include Refresh, Reset, Modify, Close, and Help...



ONT Provisioning

- Assign VLANs once ONTs are ranged

The screenshot shows the 'Create Ethernet Port Service Profile' window. The profile name is 'VulP_150'. The service type is 'Bridged NN'. The class of service is 'nrl-VBR'. The 802.1p marking mode is 'COPY' and the marked 802.1p priority is '6'. The network VLAN is '150' and the subscriber VLAN is '150'. The service protocol is 'Transparent'. The PPPoE section is unchecked. The rate section has 'Downstream' shaping set to 'Disable' and 'Upstream' rates of 5120 Kbps peak, 512 Kbps sustained, and 512 Kbps guaranteed. The circuit ID template is '%TID% eth %SHE1.P%/%SLOT1%/%PON%/%ONT1%/%PORT1%'. The LLDP DSCP is '0' and the LLDP application type is '1'. The ACL profile is 'SticlyMAC_2'.

The screenshot shows the 'NetHorizon - CPE Connection On Device core-olt' window. The 'Select GEM Port' section has 'Slot 1 - GPON-8 - Running' selected. The 'Bridge Logical' section has 'Transparent LANSingleTa' selected. The 'Name' field is empty, and the 'VLAN ID (0..4090)' is '50'. The 'CPE Connection' section has 'Type' set to 'Ethernet UNI', 'UNI Port' set to '1', and 'UNI VLAN' set to '0'. The 'RG Mode' is 'Bridged'.



Optical Levels

- OLTs and ONTs will report optical transmit and receive levels
- Provides basic indication of connection problems
- Not intended to replace cable plant certification



Type-B Protection

- Provides sub-80ms switchover protection between PON ports on same OLT
- Redundant OLTs an option
- Switchover between OLTs requires re-ranging

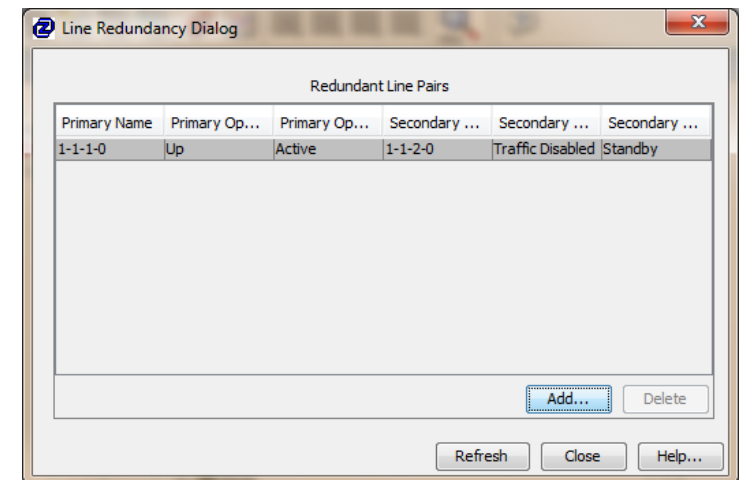

OMCI

- OLTs communicate with ONTs using ONT Management and Control Interface (OMCI)
- OMCI is part of the GPON standard and operating outside of GEM Ports
- OMCI is established after ONT is ranged

Bandwidth Assignment

- Bandwidth management is built-in to the GPON standard
- Required during provisioning



Bandwidth Management

Committed rates cannot exceed capacity of any link in the system

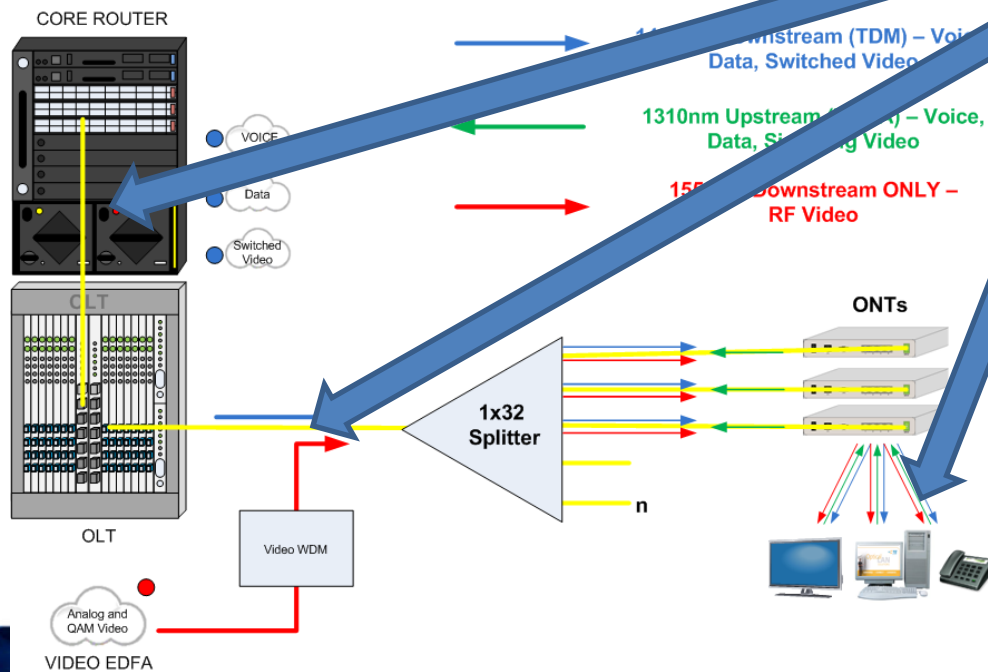

Upstream Granting

- The “Grant” is the permission sent from the OLT to the ONT to:
 - Allow the ONT to transmit traffic in its assigned timeslot on the Upstream data train
 - Control the flow of Upstream traffic from the ONTs to the OLT so collisions of traffic from different ONTs on the PON do not occur

Traffic Flow

Internal switching separates POL from carrier PON vendors

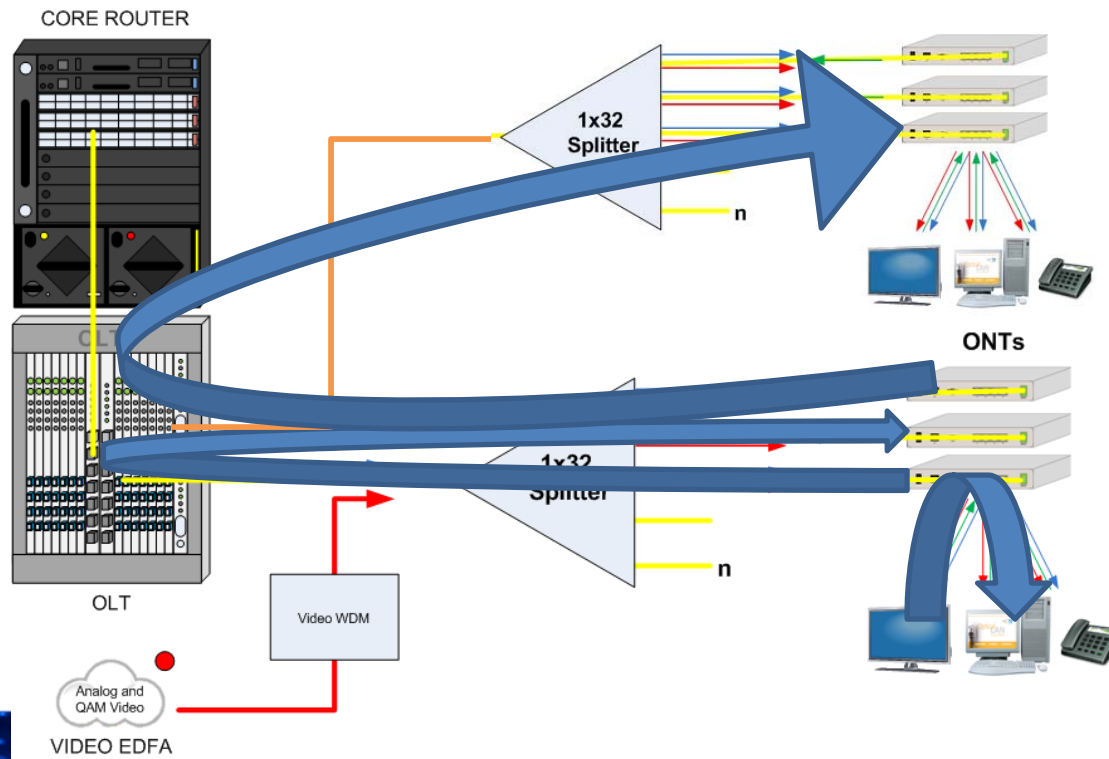

1. Within ONT
2. Within PON Card
3. Within OLT

GPON Encapsulation

- VLANs mapped to GEM Ports
- GEM Ports assigned to traffic containers
- GEM Ports mapped to ONTs

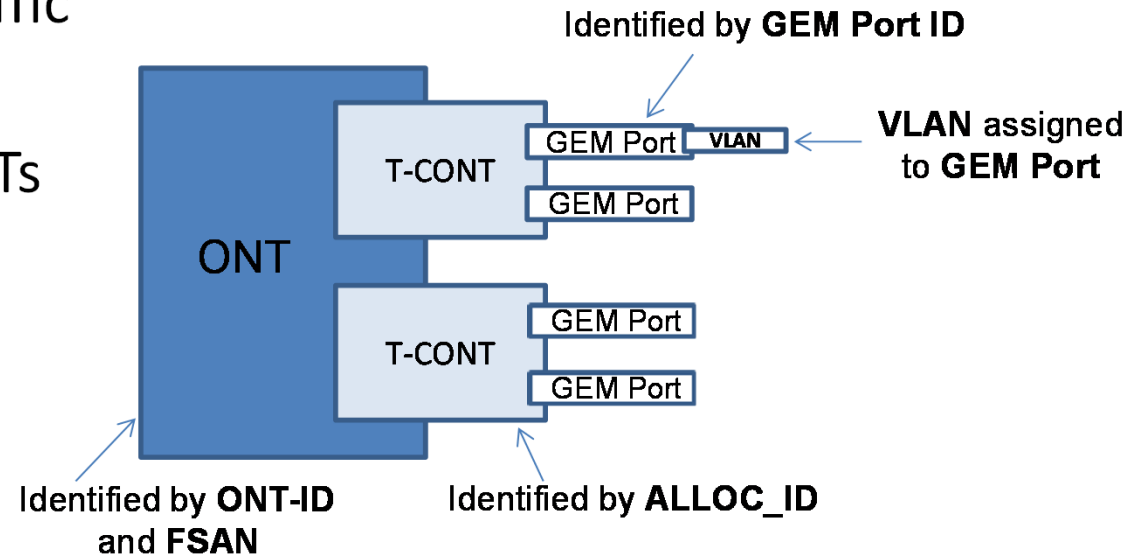

Tagging, LLDP, PoE, QoS

- Tag VLANs from ONT
- Deliver power
- Configure connected devices with LLDP
- Customize QoS

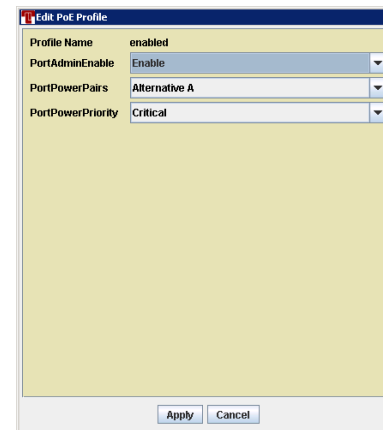

STP & Loop Detection

- Full STP is not required in POL networks
- Loop detection is important

Dialog box titled "Edit Ethernet Port RSTP Profile" showing configuration for "BPDU_Security".

Profile Name	BPDU_Security
Administrative State	Enable
Path Cost	20000
Port Priority	128
Port Hello Time (secs)	2
Admin Point-to-Point MAC	Auto
<input checked="" type="checkbox"/> Admin Edge Port	<input checked="" type="checkbox"/> Restricted Role
<input checked="" type="checkbox"/> Restricted TCN	<input type="checkbox"/> Enable TCN Notification
<input type="checkbox"/> Enable Root Protected Notification	<input checked="" type="checkbox"/> Enable BPDU Guard Violation

Buttons: Apply, Cancel



Multicast

- Multicast compliments PON topology
- OLTs and ONTs feature IGMP snooping
- Specific multicast VLAN required

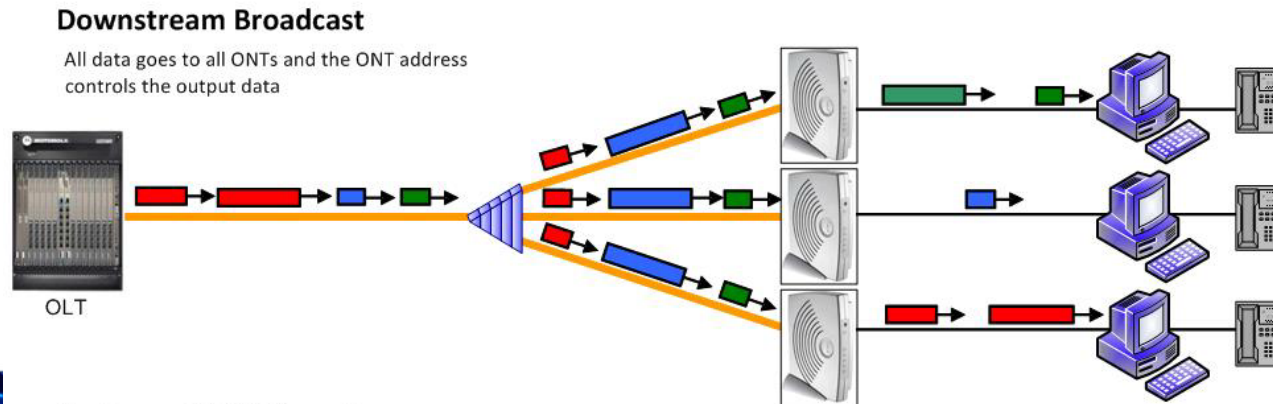

Rules & Auto-Port Provisioning

- Auto-provision ONTs upon detection
- Set rules or selectors based upon ONT properties (location, model, etc.)

Create Equipment Selector

Equipment Selector

Selector Name: Slot-2_PON-3_709ONs_Port1

ONT Type: ONT709

AID Range

AID Type	Port
I/O Slot	2
PON	3
ONT	*
Port	1
Number of Equipment	1
First AID	ETH1-2-3-*-1

Note: Type in "*" to indicate any.

Apply Cancel

Converging Standards

- IEEE and ITU working to converge standards in future generations
- 10G EPON and XGPON use same PHYs



Future Standards

- EPON/GPON Networks can co-exist on the same fiber & splitters as 10G EPON/XGPON Networks
- 10G EPON and XGPON use same PHYs
- IEEE and ITU working to converge standards in future generations
- Next standards may combine multiple wavelengths in each direction for additional bandwidth



Complimentary Wavelengths

EPON/GPON

1490nm Down / 1310nm Up

10G EPON/XGPON

1577nm Down / 1270nm Up

RF Video

1550nm Down

Bicsi



Migration to 10G

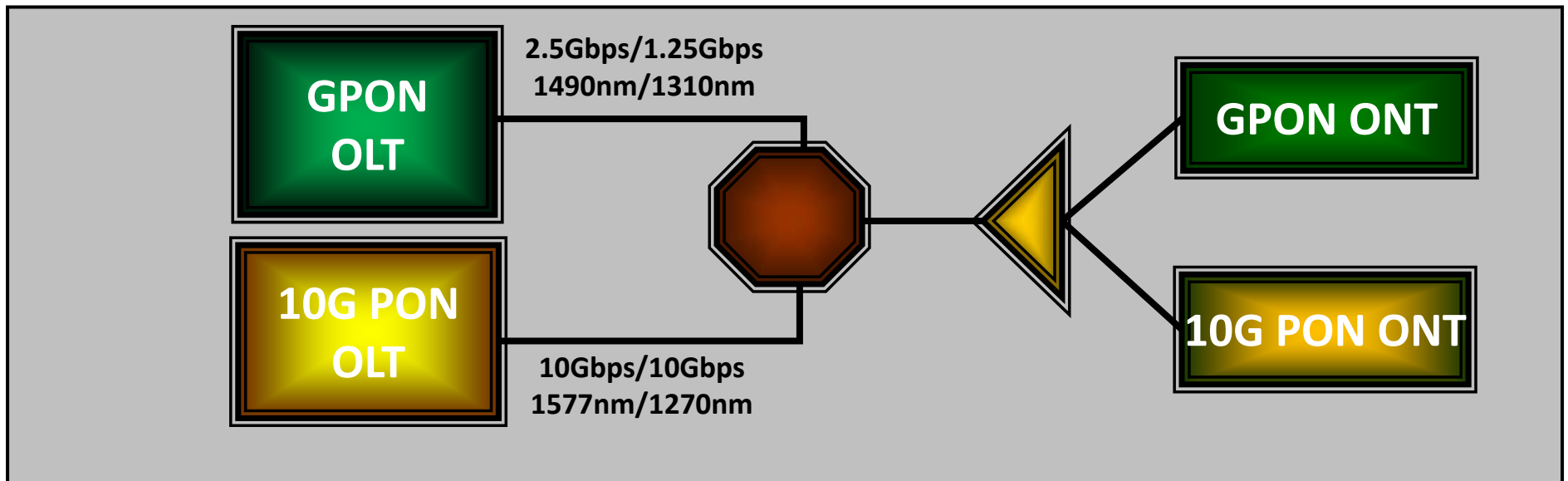

7

- 10G PON can coexist on the same fiber as GPON
- Bandwidths available as 10G Downstream and 10G/2.5G/1G Upstream
- Uses same infrastructure/splitters as GPON
- Casual migration – upgrade only the ONTs that you want

Questions?

Passive Optical LAN Integration & Management

Matt Miller
Sr. Solutions Architect, CallisonRTKL



POL Project Closeout Package



Bicsi



Suggested Contents

- Rack Elevation Drawings
- As-Built Drawings
- Interconnect Documentation
- Test Results
- Datasheets and Documentation



Rack Elevation Drawings

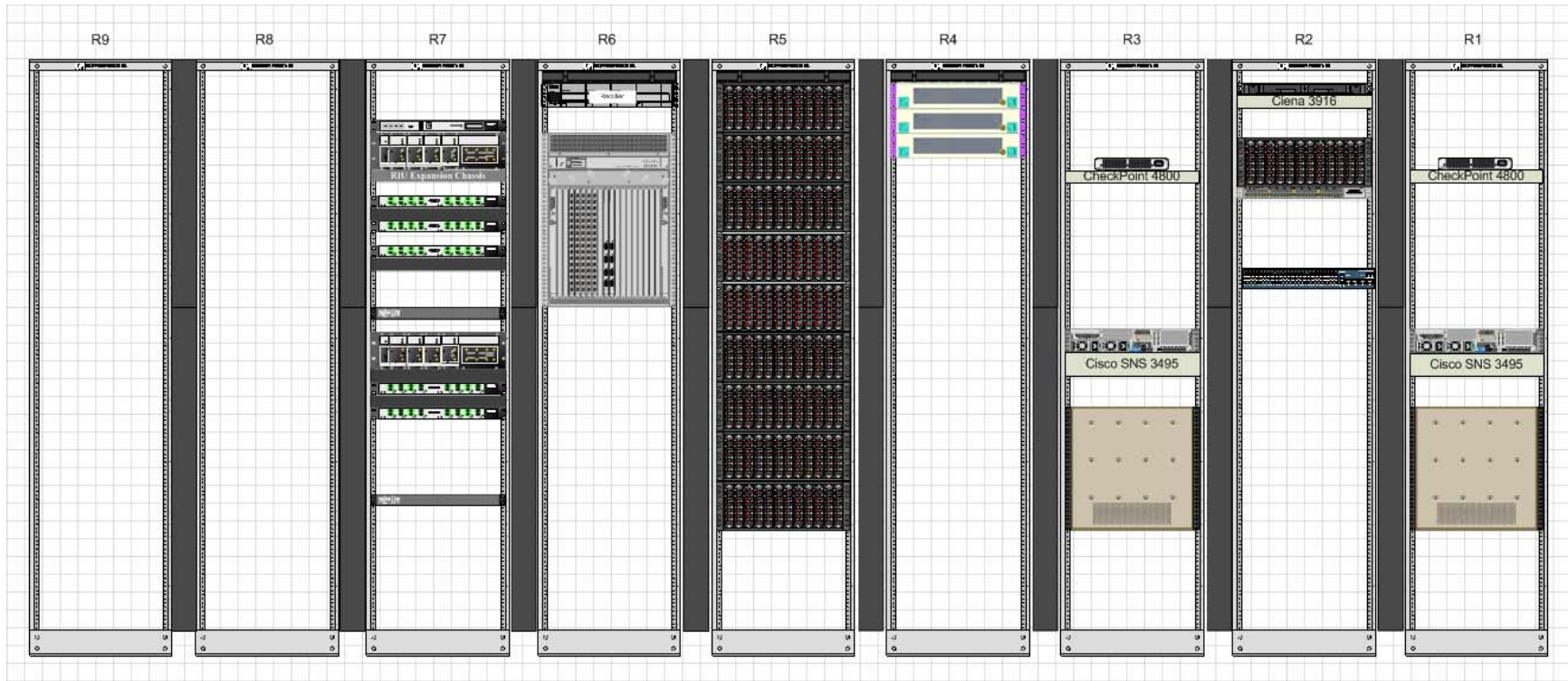

As-Built Drawings

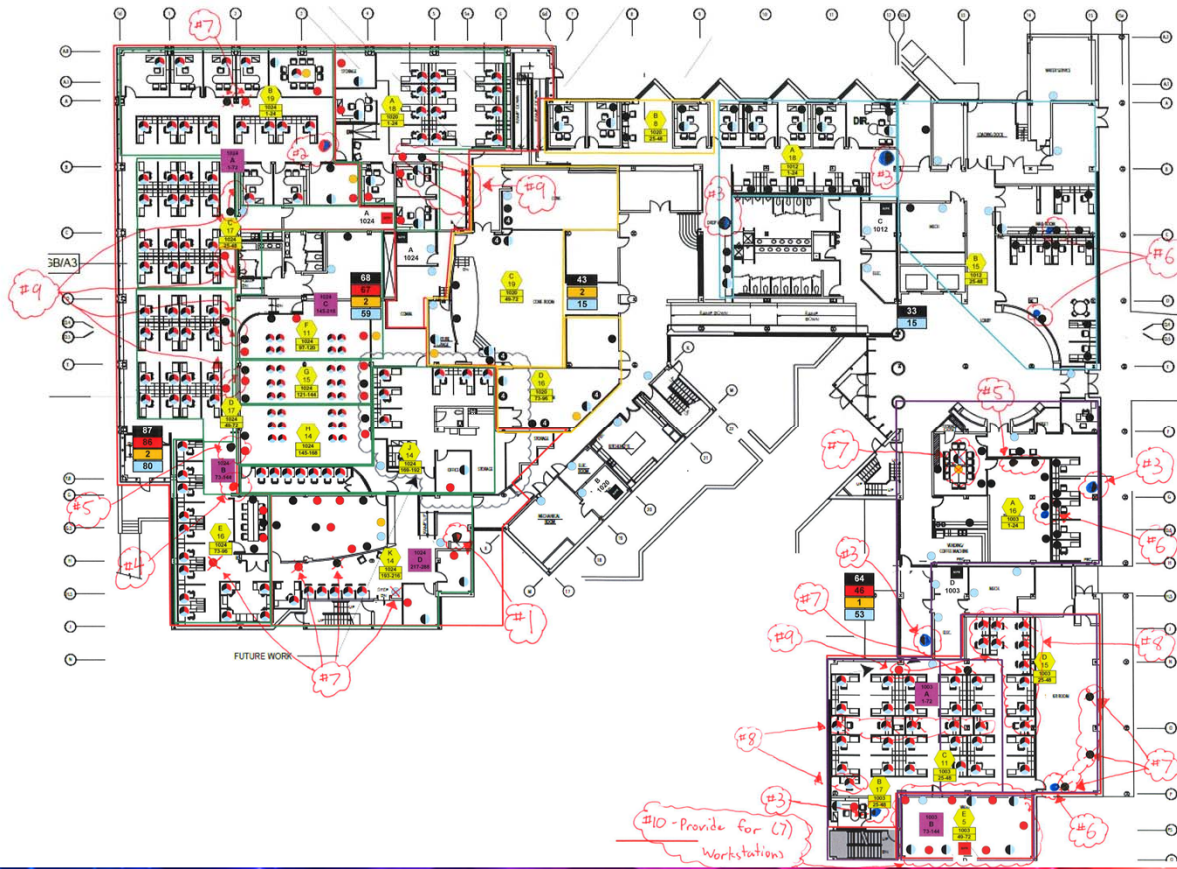

Interconnect Documentation

Site	Building	OLT Rack	OLT Chassis	PON Card	PON Port	VAM Shelf	VAM Module	VAM Port	Backbone Shelf	Riser Cable	Backbone Port
Las Veags	Mandalay Bay	MDF Rack 6	ManBay001	4	16	1	8	2	2	2	1
Las Veags	Mandalay Bay	MDF Rack 6	ManBay001	4	16	1	8	2	2	2	1
Las Veags	Mandalay Bay	MDF Rack 6	ManBay001	4	16	1	8	2	2	2	1
Las Veags	Mandalay Bay	MDF Rack 6	ManBay001	4	16	1	8	2	2	2	1
Las Veags	Mandalay Bay	MDF Rack 6	ManBay001	4	16	1	8	2	2	2	1
Las Veags	Mandalay Bay	MDF Rack 6	ManBay001	4	16	1	8	2	2	2	1
Las Veags	Mandalay Bay	MDF Rack 6	ManBay001	4	16	1	8	2	2	2	1
Las Veags	Mandalay Bay	MDF Rack 6	ManBay001	4	16	1	8	2	2	2	1
Las Veags	Mandalay Bay	MDF Rack 6	ManBay001	4	16	1	8	2	2	2	1
Las Veags	Mandalay Bay	MDF Rack 6	ManBay001	4	16	1	8	2	2	2	1
Las Veags	Mandalay Bay	MDF Rack 6	ManBay001	4	16	1	8	2	2	2	1
Las Veags	Mandalay Bay	N/A	N/A	N/A	N/A	N/A	N/A	N/A	N/A	N/A	N/A



Interconnect Documentation

FDH	FDH Location	Splitter	Splitter Fiber	FDH Port	RDT	RDT Port Count	RDT Location	RDT Port	Drop #	Room Number	ONT Model	ONT SN#
MB1	3rd floor mechanical room across from 313	1	1	1	1	1-12	Located in front of 115	1	1	GUEST RM 2	ONT 123	90D7B
MB1	3rd floor mechanical room across from 313	1	2	2	1	1-12	Located in front of 115	2	2	120	ONT 123	90F2F
MB1	3rd floor mechanical room across from 313	1	3	3	1	1-12	Located in front of 115	3	3	119	ONT 123	90D75
MB1	3rd floor mechanical room across from 313	1	4	4	1	1-12	Located in front of 115	4	4	116	ONT 123	910D4
MB1	3rd floor mechanical room across from 313	1	5	5	1	1-12	Located in front of 115	5	5	117	ONT 123	90F49
MB1	3rd floor mechanical room across from 313	1	6	6	1	1-12	Located in front of 115	6	6	114	ONT 123	90FCF
MB1	3rd floor mechanical room across from 313	1	7	7	1	1-12	Located in front of 115	7	7	115	ONT 123	9130E
MB1	3rd floor mechanical room across from 313	1	8	8	1	1-12	Located in front of 115	8	8	113	ONT 123	90D72
MB1	3rd floor mechanical room across from 313	1	9	9	1	1-12	Located in front of 115	9	9	112	ONT 123	910C6
MB1	3rd floor mechanical room across from 313	1	10	10	1	1-12	Located in front of 115	10	10	111	ONT 123	90E09
MB1	3rd floor mechanical room across from 313	1	11	11	1	1-12	Located in front of 115	11	11	118	ONT 123	90F08
MB1	3rd floor mechanical room across from 313	N/A	N/A	12	1	1-12	N/A	12	Spare	N/A	N/A	N/A



Interconnect Documentation

ONT GE Port 1 Device	ONT GE Port 1 MAC	ONT GE Port 2 Device	ONT GE Port 2 MAC	ONT GE Port 3 Device	ONT GE Port 3 MAC	ONT GE Port 4 Device	ONT GE Port 4 MAC	ONT POTS Port 1	ONT POTS Port 2	RF Port	WAP MACs	Notes
Active	N/A	N/A	N/A	N/A	N/A	N/A	N/A	Active	N/A	N/A	N/A	N/A
Active	N/A	N/A	N/A	N/A	N/A	WAP	F40F1B7E0CF8	Active	N/A	N/A	F40F1B7E0CF8	N/A
Active	N/A	N/A	N/A	N/A	N/A	N/A	N/A	Active	N/A	N/A	N/A	N/A
Active	N/A	N/A	N/A	N/A	N/A	N/A	N/A	Active	N/A	N/A	N/A	N/A
Active	N/A	N/A	N/A	N/A	N/A	N/A	N/A	Active	N/A	N/A	N/A	N/A
Active	N/A	N/A	N/A	N/A	N/A	N/A	N/A	Active	N/A	N/A	N/A	N/A
Active	N/A	N/A	N/A	N/A	N/A	WAP	F40F1B7F2B34	Active	N/A	N/A	F40F1B7F2B34	N/A
Active	N/A	N/A	N/A	N/A	N/A	N/A	N/A	Active	N/A	N/A	N/A	N/A
Active	N/A	N/A	N/A	N/A	N/A	WAP	F40F1B6373D8	Active	N/A	N/A	F40F1B6373D8	N/A
Active	N/A	N/A	N/A	N/A	N/A	N/A	N/A	Active	N/A	N/A	N/A	N/A
Active	N/A	N/A	N/A	N/A	N/A	WAP	88F0316C59B4	Active	N/A	N/A	88F0316C59B4	N/A
N/A	N/A	N/A	N/A	N/A	N/A	N/A	N/A	N/A	N/A	N/A	N/A	N/A



Test Results

FasTesT Report

General Information

Filename:	MandalayBay2.olts	Cable ID:	AP 2.0 - Mandalay Bay
Test date:	3/30/2015	Fiber ID:	FIBER001; FIBER002; FIBER003; FIBER004; FIBER005; FIBER006; FIBER007; FIBER008; FIBER009; FIBER010; FIBER011; FIBER012
Test time:	2:28 PM; 2:30 PM; 2:31 PM; 2:32 PM; 2:33 PM; 2:34 PM	Customer:	Mandalay Bay
Job ID:	AP 2.0 - Mandalay Bay	Company:	Sin City Cabling
Comments:			

Location A

Location: Wayne Newton
 Unit's model: FOT-932
 Unit's s/n: 767843

Location B

Location: Celine Dion
 Unit's model: FOT-932
 Unit's s/n: 774536

FasTesT

Fiber ID	Wavelength (nm)	Loss A->B (dB)	Ref. A->B (dB)	Loss B->A (dB)	Ref. B->A (dB)	Average (dB)	ORL A->B (dB)	ORL B->A (dB)	Length (ft)
FIBER001	1310	0.39	N/A	1.30	N/A	0.82	42.59	40.05	N/A
FIBER002	1310	0.59	-1.26	0.63	0.87	0.61	42.30	41.61	2,112.7000
FIBER003	1310	0.52	-1.26	0.51	0.87	0.52	42.88	>42.52	2,111.3000
FIBER004	1310	0.37	-1.26	0.44	0.87	0.40	43.58	>42.37	2,115.6000
FIBER005	1310	0.34	-1.26	0.37	0.87	0.36	42.01	>42.25	2,113.2000
FIBER006	1310	1.74	-1.26	1.74	0.87	1.74	42.41	36.18	2,110.6000
FIBER007	1310	0.68	-1.26	0.81	0.87	0.75	38.39	34.97	2,109.1000
FIBER008	1310	0.54	-1.26	0.63	0.87	0.59	42.72	>42.76	2,105.7000
FIBER009	1310	1.51	-1.26	1.60	0.87	1.55	43.27	42.14	2,103.3000
FIBER010	1310	0.45	-1.26	0.56	0.87	0.51	43.54	>42.62	2,105.2000
FIBER011	1310	0.57	-1.26	0.61	0.87	0.59	43.38	42.61	2,107.7000
FIBER012	1310	1.24	-1.26	1.24	0.87	1.24	43.28	40.66	2,104.9000

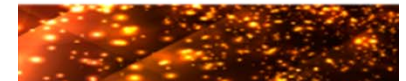

Datasheets and Documentation



Questions?

Passive Optical LAN Design

Bicsi



APOLAN

Founding Members:



www.apolanglobal.org

Bicsi®

