



“Passive Optical LAN - Game Changer: An Integrator’s Perspective”

Para Munaweera
BSc,MSc,MBA



2018 BICSI Fall Conference & Exhibition



Today's Session

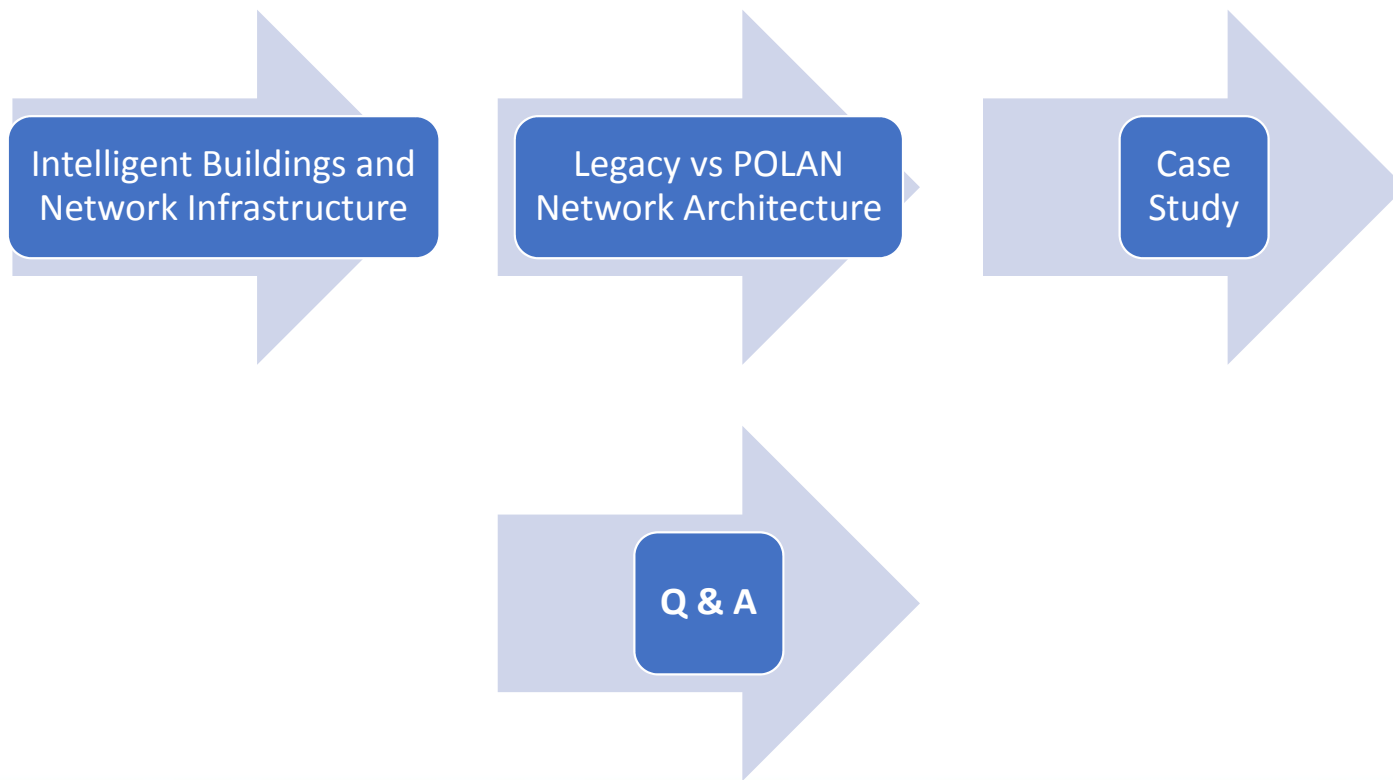

Intelligent Buildings and Network Infrastructure



Intelligent Buildings and Network Infrastructure

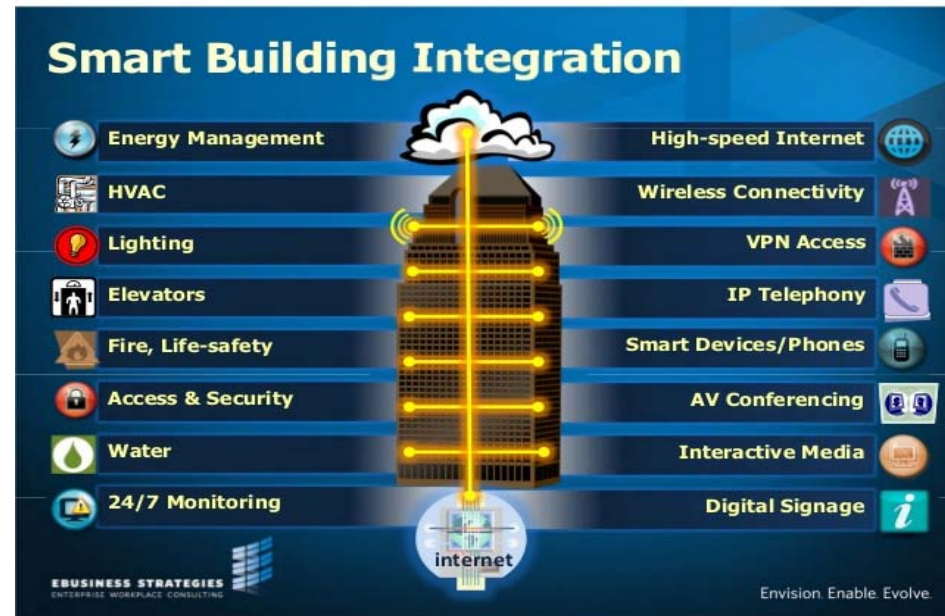
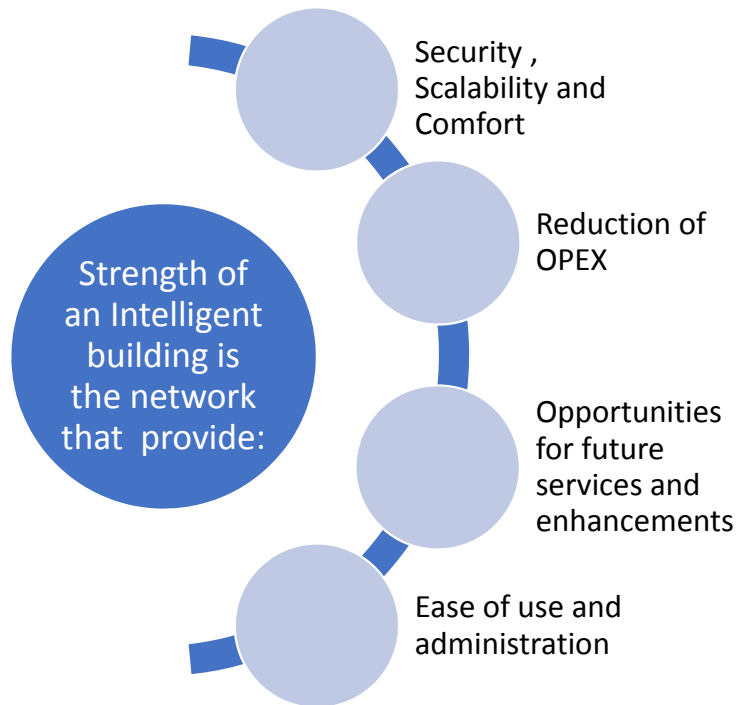

Demand for bandwidth for intelligent building and integration of services is the key for LAN upgrade



2018 BICSI Fall Conference & Exhibition



Bicsi

Drivers of LAN Upgrade

Convergence

Legacy LAN typically need parallel sub-systems (equipment, cabling and management) to deliver voice, data, video, CCTV, security, WiFi, public announcements...

Reduce costs with one network to deliver all services



High capacity

Remove the bottlenecks with a Gigabit network to increase the efficiency and communication between employees, suppliers and customers

Improve the business performance



Mobility

New WiFi technologies require refresh of all LAN switches with N- BASE-T and replacement of cables.

- 802.11ac Wave 1 - require 1Gb/s
- 802.11ac Wave 2 – require 3.6Gb/s
- 802.11ax – require 10Gb/s

Efficient WiFi backhaul today and in the future



Being smart with your investment means investing the same amount of money in new technology that will help you answer the challenges



POLAN – Network of Future

The primary drivers contributing to a successful POLAN adoption are:

- Scalability and reliability
- Ease of use and administration
- Energy savings and environmental sustainability
- Optimized bandwidth connectivity
- Advanced security
- Lowest total cost of ownership (TCO)
- Sustainability: Reducing the carbon footprint



Evolution of PON Technology

Technology Evolution

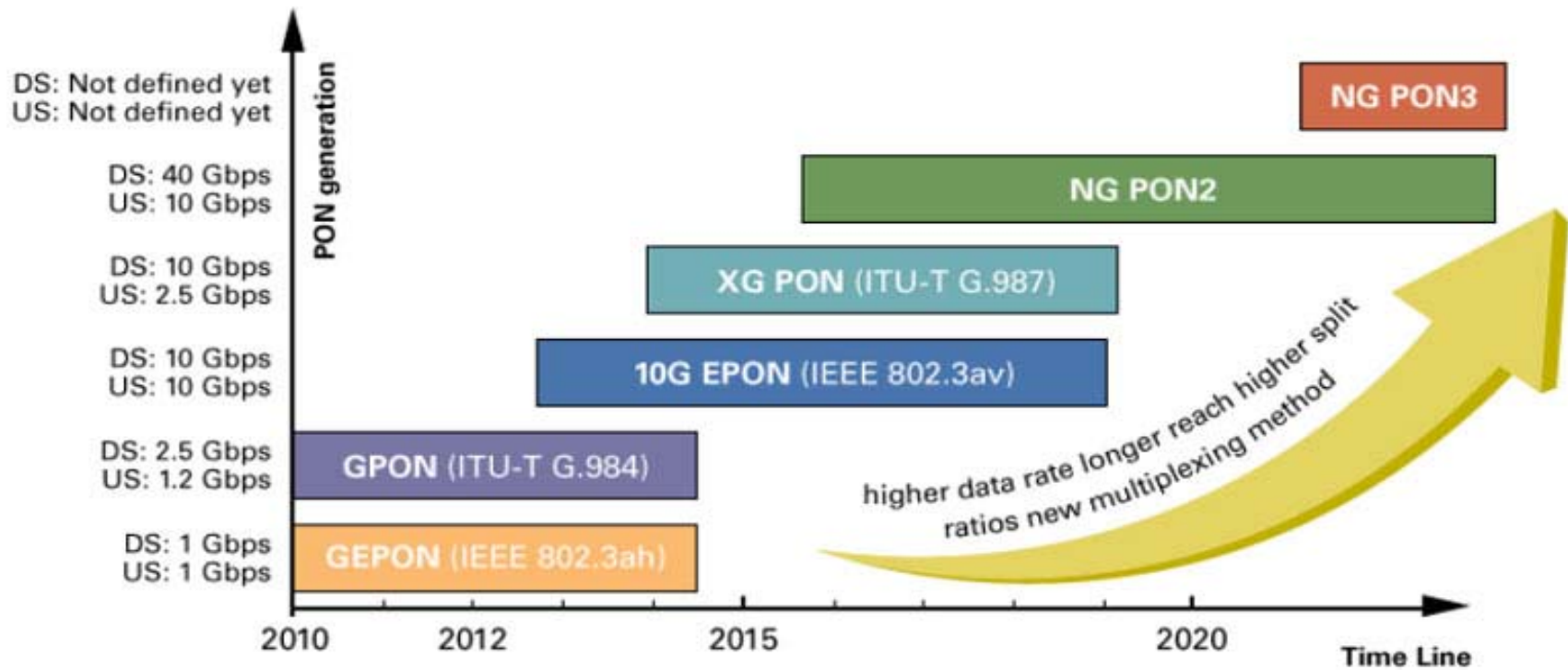

Passive Optical Local Area Network

Based on Gigabit Passive Optical Networks (GPON) technology

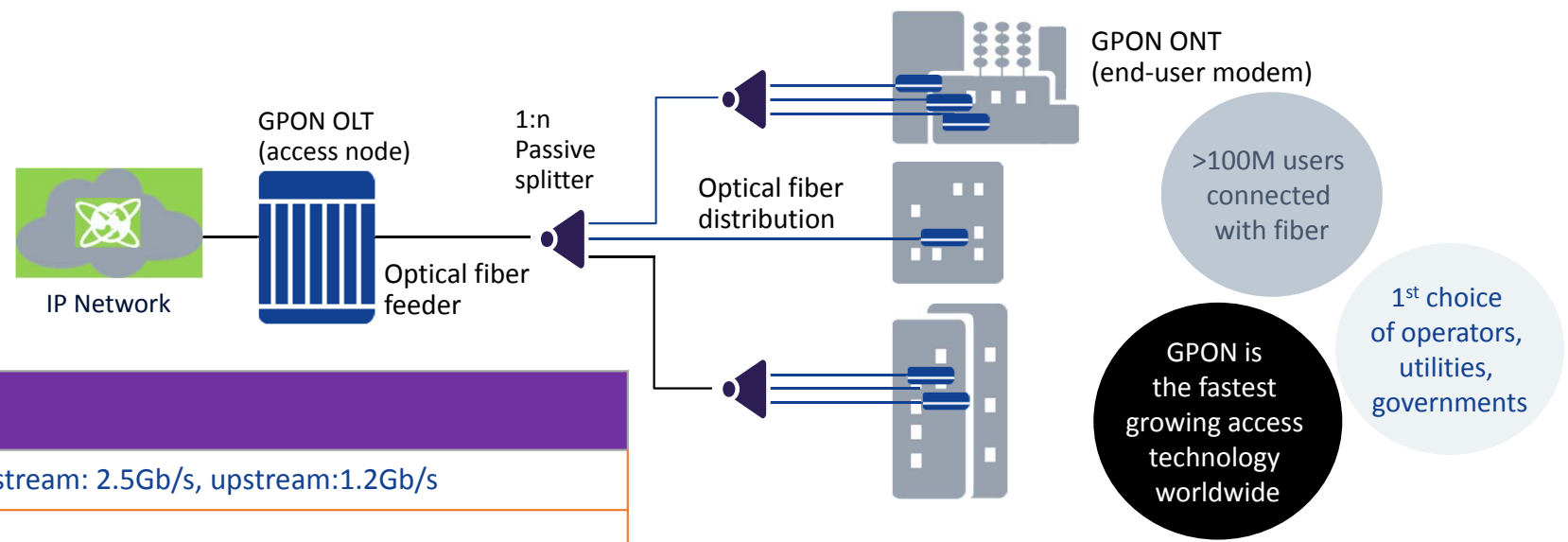

GPON Key facts	
Bandwidth per PON	Downstream: 2.5Gb/s, upstream:1.2Gb/s
Bandwidth per user	1Gb/s
Outside plant	Passive. Split 1:128. Reach: 20km
Services	Data, voice, video, WiFi backhaul
Evolution	Graceful migration to TWDM-PON 40Gb/s symmetrical

Ref: Nokia POLAN

Passive Optical Local Area Network

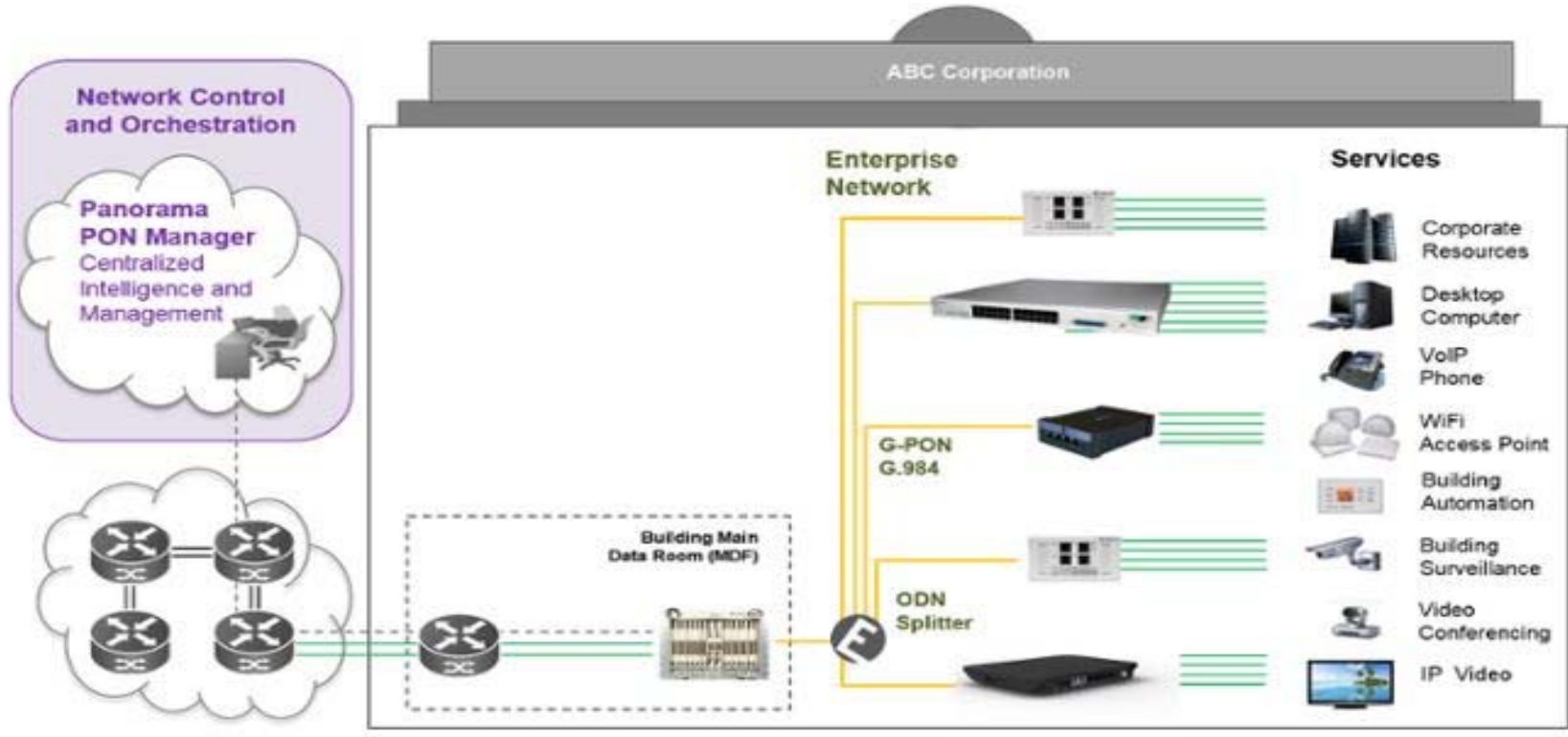

Ref: Tellabs



2018 BICSI Fall Conference & Exhibition



Legacy vs POLAN Network Architecture

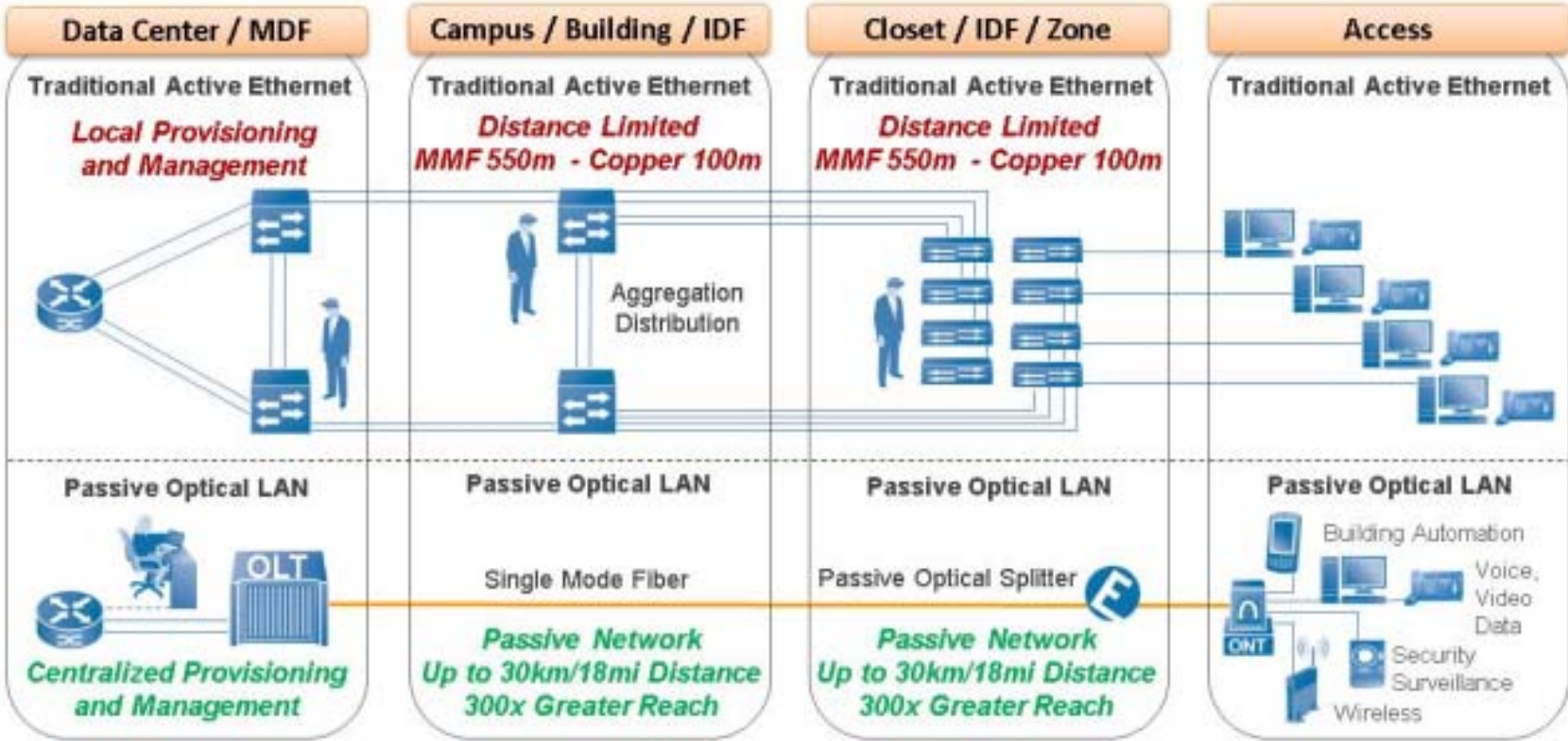
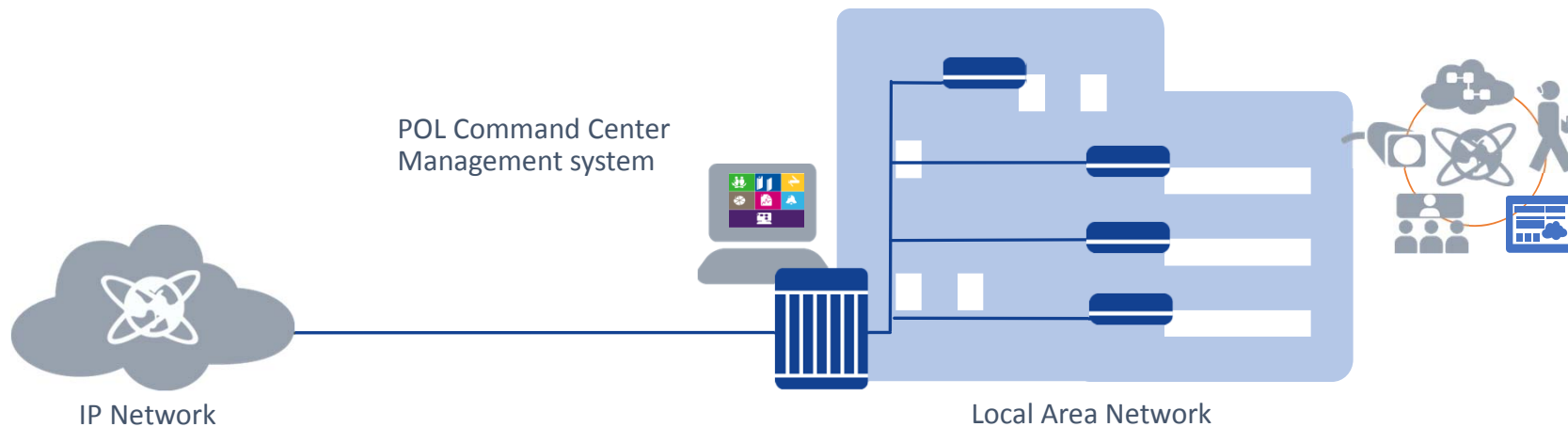

Figure 1: Comparing the configurations of a Passive Optical LAN to a traditional copper-based active Ethernet LAN



Exceed the expectations of your LAN performance with POLAN (Passive Optical LAN)



Premium service experience

- High capacity, market proven solution
- All services converged on one LAN
 - voice, video, data, WiFi, surveillance, signage, etc

Lower cost to operate

- Simple network, easy to operate
- Low power consumption
- Low floor space

Long term solution

- Fiber life span: 50+ years
- Low cost evolution:
 - same cables
 - same access node

Ref: Nokia POLAN



2018 BICSI Fall Conference & Exhibition



Benefits of Passive Optical LAN

Fibre to the Office : 50% TCO savings with Passive Optical LAN

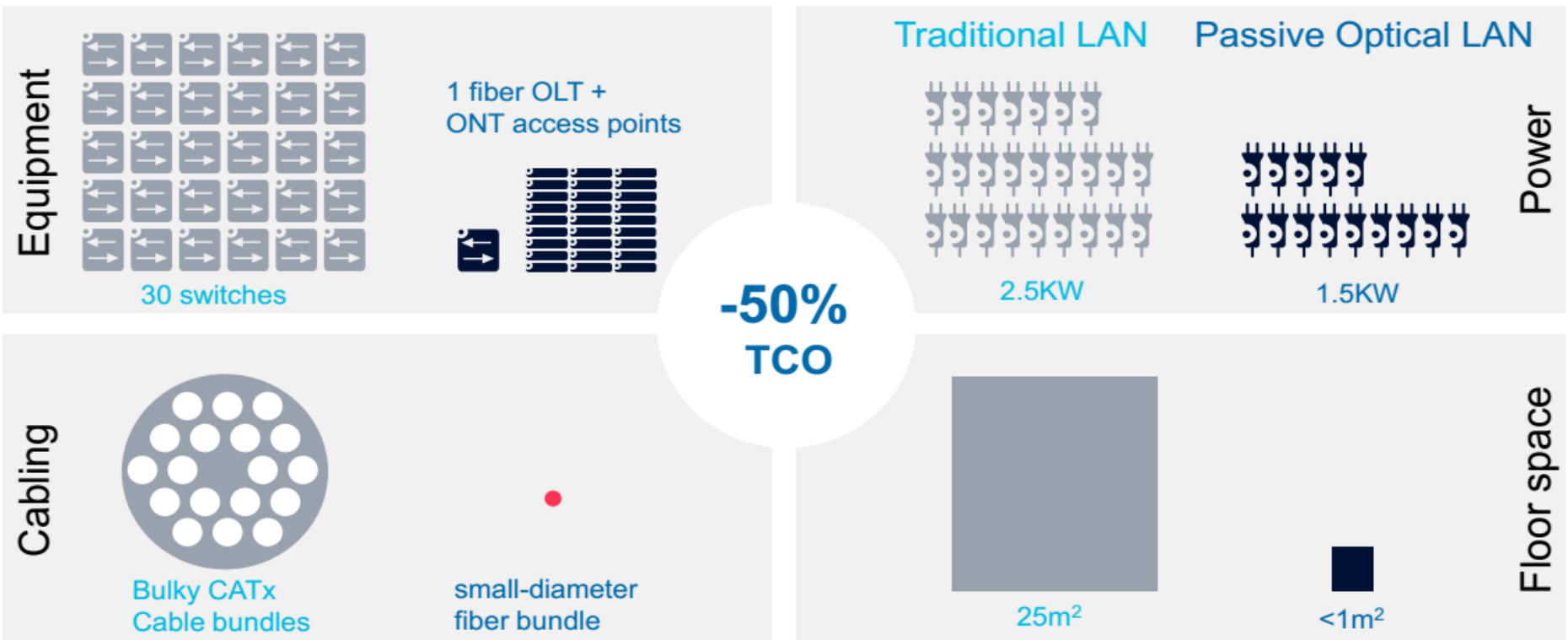

Ref: Nokia POLAN



2018 BICSI Fall Conference & Exhibition



Benefits of Passive Optical LAN

Structured Cabling vs. POL (typical values)

	Optical Fiber	Copper
CAPEX cost (2K-user optical LAN)	<\$300,000	>\$1,000,000
Lifecycle	30-50 years	Approx. 5 years
Distance	12 miles	300 feet
Weight (per 1K Ft.)	4 lbs.	39 lbs.
Energy consumed	2 watts per user	More than 10 watts per user
Maximum bandwidth	69 Tbps	10 Gbps
Security	Hard to tap, easy to alarm	Emits EMI



Benefits of Passive Optical LAN

- Up to 70% less capex.
- Up to 80% less power consumption
- Up to 90% less space Utilization
- Graceful migration to fully converged IP Network
- Future proof fiber optic cabling infrastructure
- With less quantity and smaller size fiber cabling, Optical LAN can reduce cabling plastics by 65%
- 5 – 9's reliability, Physical redundancy and provisional QOS



2018 BICSI Fall Conference & Exhibition



Bicsi

Benefits of Passive Optical LAN - Space Saving

Better utilization for the IDF space

Legacy
Copper LAN
2,000 Gigabit Ethernet
In Eighteen (18) racks



Optical LAN
8,000 Gigabit Ethernet
In One (1) rack



2018 BICSI Fall Conference & Exhibition



Bicsi

Benefits of Passive Optical LAN

- Central Management System
- Elimination of Security Breach
- The POLAN does not require switching in the distribution layer and replaces it with dedicated optical arrays. Helps total flow of the data in the network.
- Easy Management (OLT and ONT only)



2018 BICSI Fall Conference & Exhibition



Bicsi

POLAN Benefits - Network Reliability

Legacy
Copper
Based
LAN

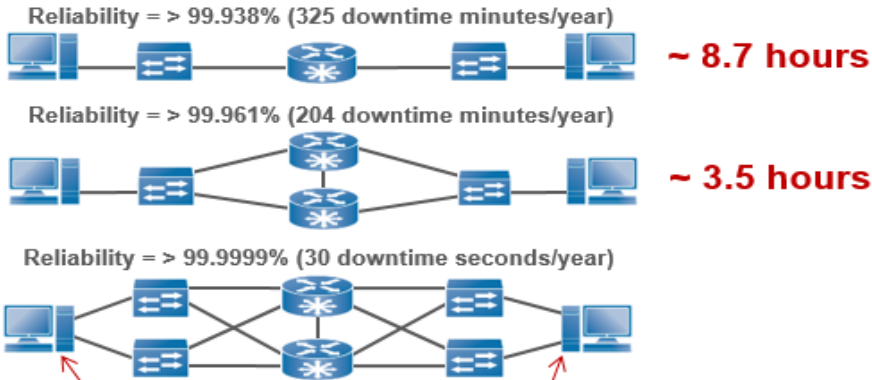

This architecture requires two network interface cards in each end-user workstation

Passive
Optical
LAN

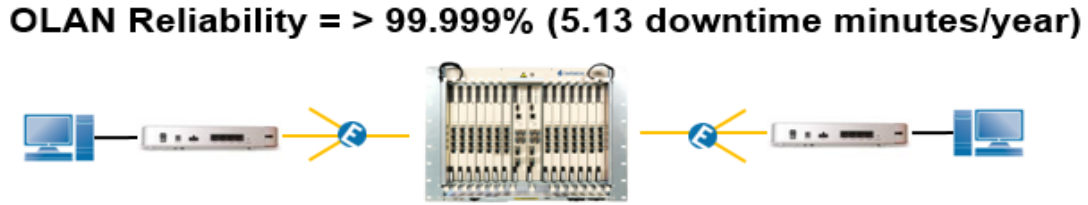

Benefits of POLAN

- The system provides a 99.999% high availability with 15 years MTBF for the ONTs and 25 Years MTBF for the OLTs. This leads to 6 9s downtime per year. (Average annual LAN downtime is 30 seconds with lower MTBFs).
- A 2:N PON optical splitter provides two optical paths to and from the primary and secondary PON interfaces on the OLT(s). Passive Splitters are available in 2:2, 2:4, 2:8, 2:16 and 2:32 configurations.



Benefits of POLAN - Network Security

Optical Plant Infrastructure Security

- Fiber is more secure than copper
- Fiber is not susceptible to interference nor does it introduce interference

ONT Security

- No access at ONTs
- No information stored at ONTs
- ONTs face plate can be alarmed and ONTs can be mounted in lockable covers

Element Management Security

- Role-based access for users through strict authentication and authorization
- Based on user's credentials, privileges can be defined on what user can view and modify
- Activity logging (leads to enhanced administrator training and less rogue events)
- Full IPv6 and IPsec security supported



Benefits of POLAN

Resiliency

- Dual homing to redundant datacenter (WAN) routers
- OLT equipment redundancy is provided in terms of power supply, control and interface cards
- In POL Optical plant redundancy / diversity / PON Type-B protection is available.
- OLT can be made redundant by deploying them in geographically dispersed locations



2018 BICSI Fall Conference & Exhibition



Bicsi

Benefits of POLAN

Simplicity

- Architecture is much easier and simple
- Automation with software defined resources allocated dynamically in real time.
- Accomplish faster installation, operations tasks & daily MACs by managing centrally
- IT Workforce Stability
- Less upfront training and no constant certification / recertification.



2018 BICSI Fall Conference & Exhibition



Bicsi

Benefits of POLAN

- The Legacy QoS is based on offering the best effort service to the end POLAN provides end-to-end managed QoS per port.
- With POL, the centralized management reduces time, cost and resources for the management of the network
- Many OLTs/ ONTs in different location can be managed/ connected / disconnected / monitored from one central location.
- Minimum downtime to restore services.





Passive Optical LAN Case Study : United Arab Emirates



POLAN Deployment in Hospitality Industry – Case Study

Building Facts (Mixed Development)		
No. of Buildings	4	4 Interconnected
No. of Floors	12	3 basements + 9 floors
No. of Zones	60	
No of Guest Rooms	600	
No. of Restaurants	16	
Health Club	2	
Meeting Rooms	40	
Office Rooms / Business Center	18	
Area	2,448,129 SQ FT	
Car Park / No . Of Cars	800	
No. of IDF's	60	
No. of Structured Cabling Data Points	20,000	
No. of ELV Systems	18	



POLAN Deployment in Hospitality Industry – Case Study

18 ELV Systems- System Requirements carefully identified for design

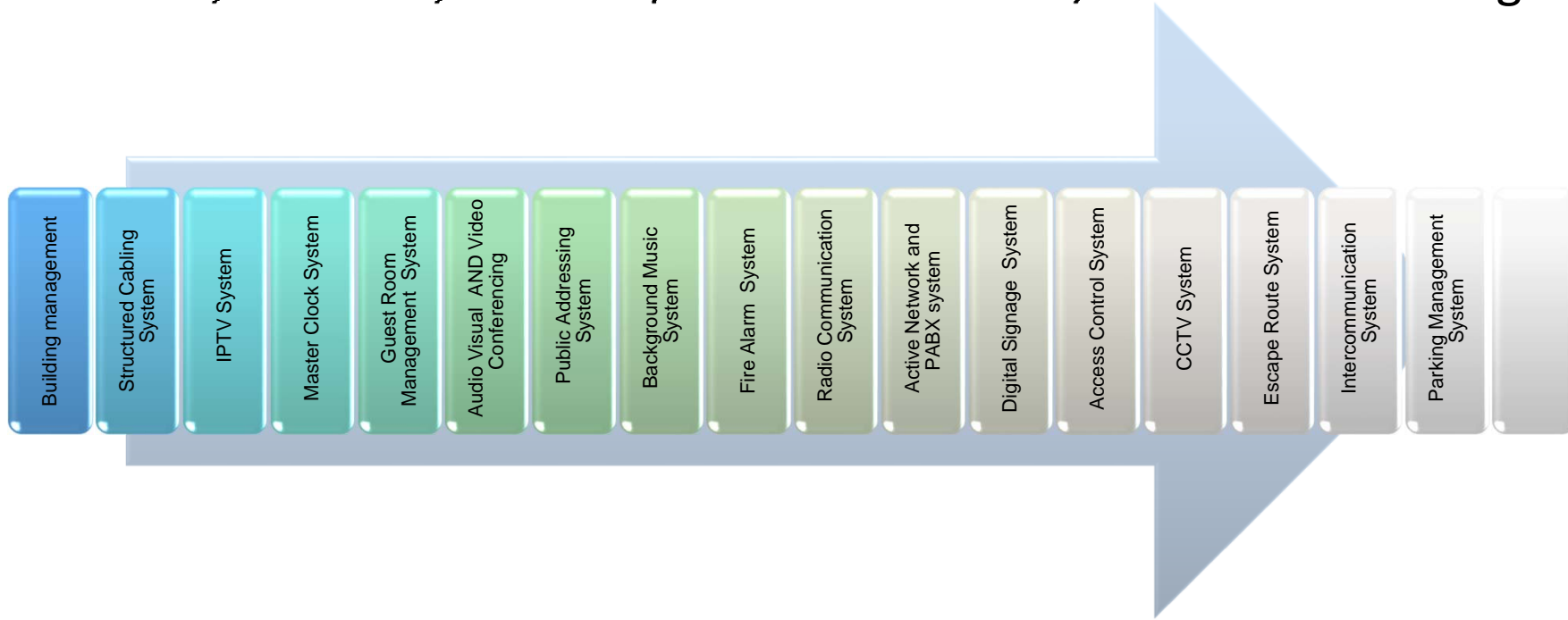

Design Considerations

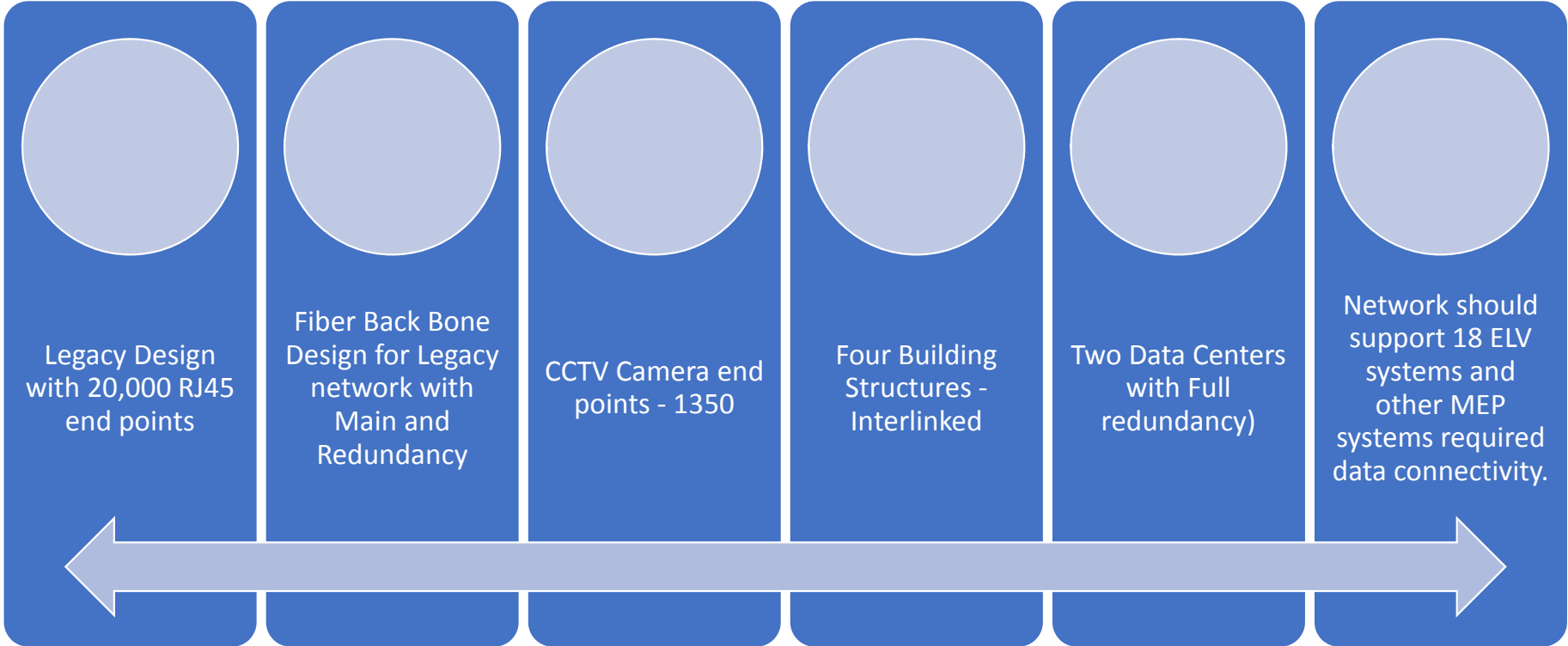

Design Considerations

- Redundant backbone cabling to all intermediate distribution frame (IDF) or telecommunications rooms (TRs) service the access layer of the network.
- 802.1x authentication for all devices to adhere with information security and protection.
- Physical security safeguards and procedures to not only limit access to both physical and virtual data and notification of intrusions
- infrastructure type and level of security should be present during any pre-design requirements phase.



Network Architecture – Main and Redundancy

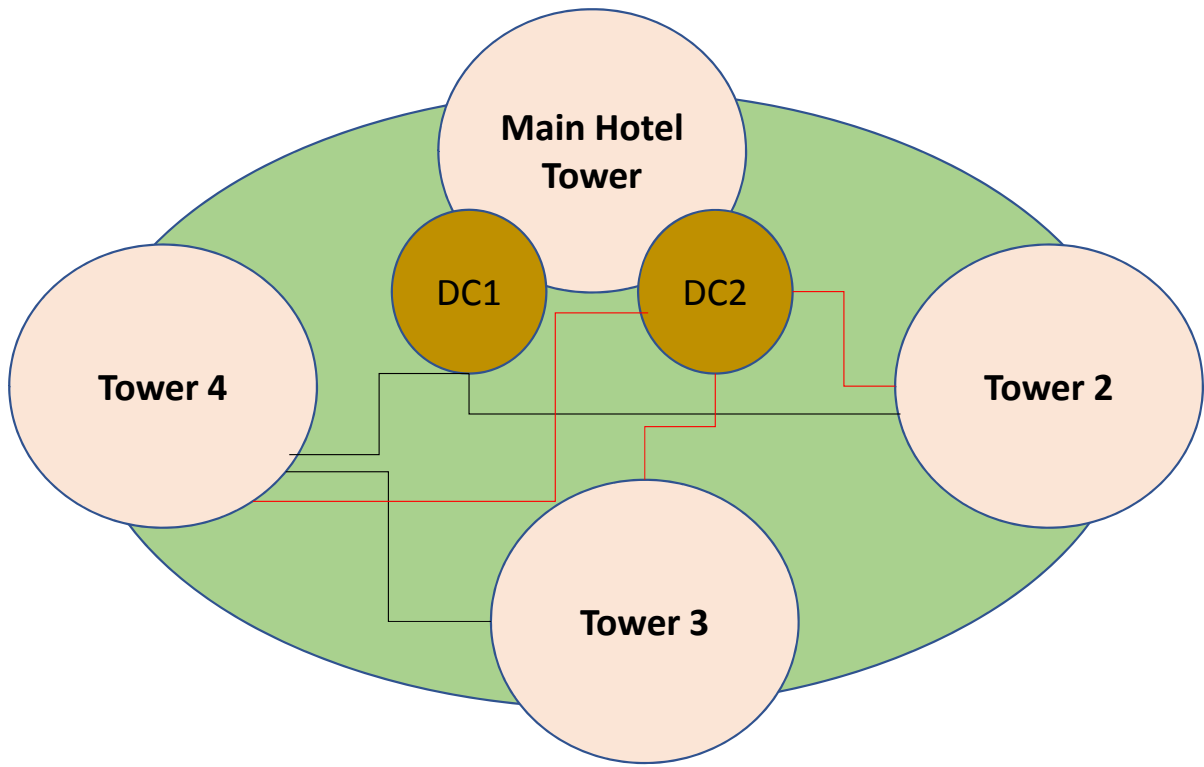

POLAN Architecture

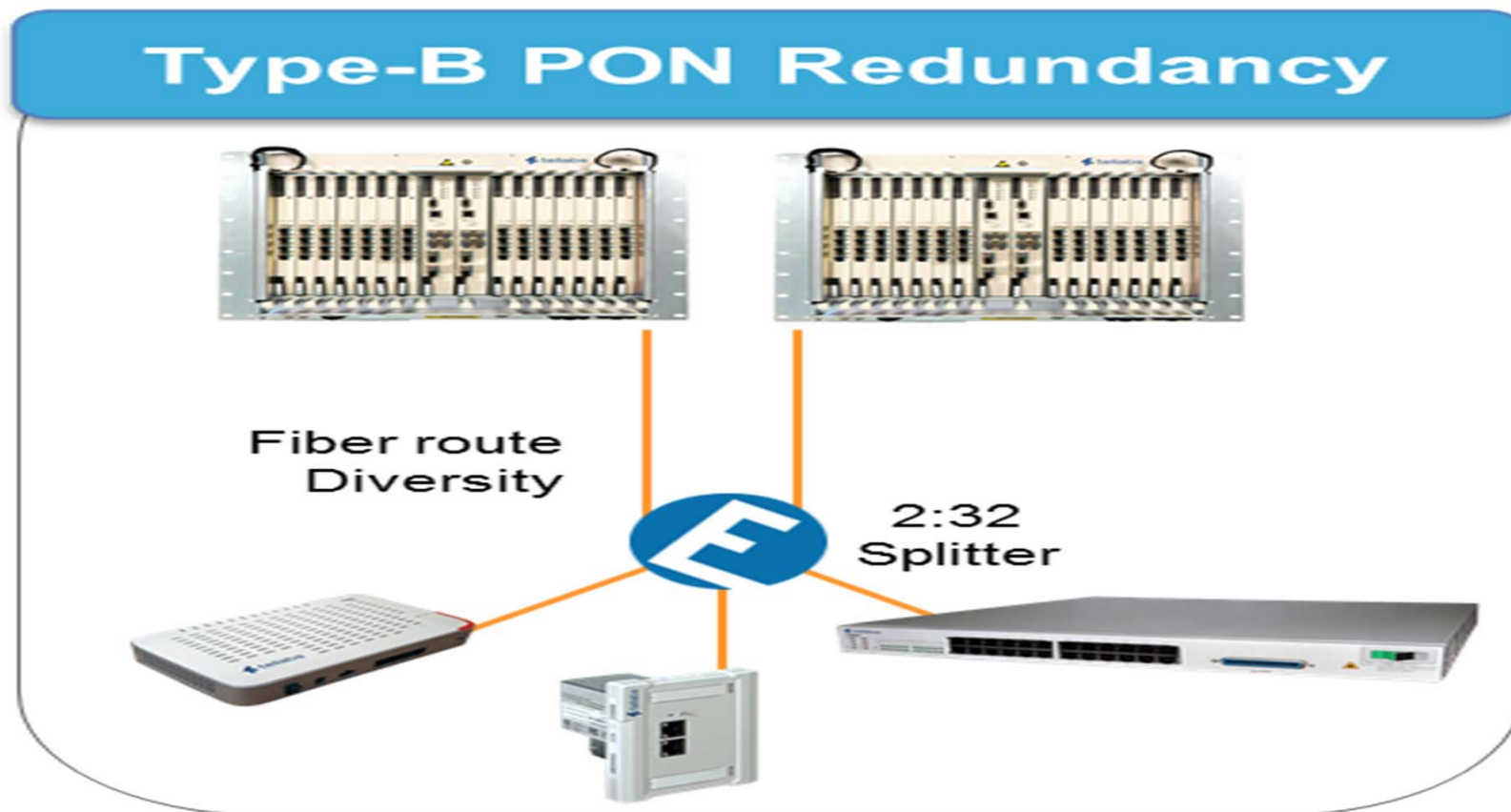

Optical Line Terminal (OLT)

Optical Line Terminal is the main brain

Functionality:

- Switching
- Central aggregation
- Replace multiple L2 switches (Distribution and Access)
- Redundancy



Optical Network Terminal (ONT):

- ONT is a media converter installed in the work area
- ONT encodes and encrypts the signal
- Three wavelengths are used between the ONT and the OLT.
 - 1310 nm voice/data transmit
 - 1490 nm voice/data receive
 - 1550 nm video receive
- ONT provides Data, VOIP, IP Video Services and POTS to the end users.
- ONT supports Power over Ethernet (PoE)

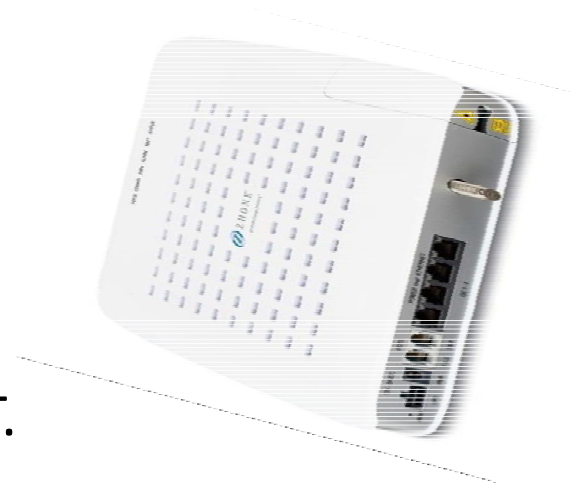

Optical Splitter and Fiber Management

- Splitters and their wall/ rack mounted closures are completely passive components.
- The function of fiber Splitters is to split single fiber into multiple fibers. They are available in “splits” (2 x 2, 2 x 4, 2 x 8, 2 x 16, 2 x 32, and 2 x 64).



3M™ Fan-out Modules

3M™ Splitter Modules



2018 BICSI Fall Conference & Exhibition



Bicsi

Optical Splitter and Fiber Management



1x8 (1-slot)

1x16 (2-slot)

1x32 (3-slot)

3M™ Splitter Modules



3M™ Splitter Panel Mount Modules



3M™ Splitter Rack Mount Shelves



Fiber Management

Cable Diameter Relative Comparison

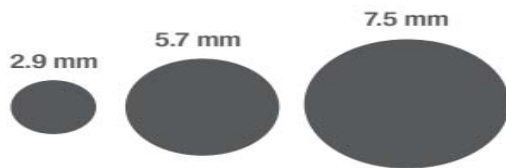

Bend Radius Relative Comparison:

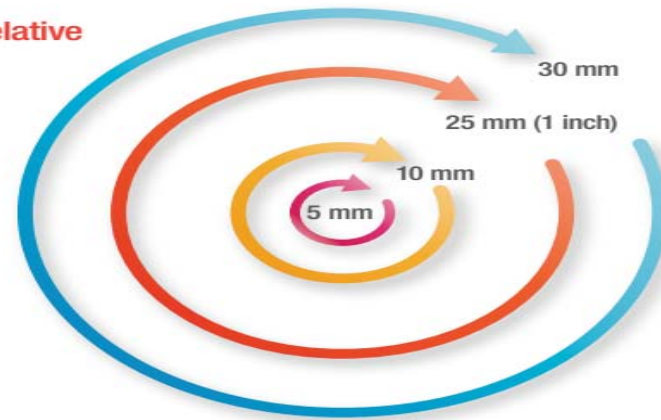

Riser-rated Cables	Bend-insensitive SM Fiber Cable	Category 6 UTP	Category 6A UTP
10G Distance	40,000 m	45 m	100 m
Cable Outer Diameter	2.9 mm	5.7 mm	7.5 mm
Weight	4 lb/1,000 ft	22 lb/1,000 ft	39 lb/1,000 ft
Minimum Bend Radius	10 mm (down to 5 mm)	22.8 mm	30 mm
Tensile Strength (Installation)	At least 50 lbf	25 lbf	25 lbf



Intended Outcomes from POLAN Deployment

- Reduction of IDF rooms from 40 to 10.
- The No. of the Splitters 2:32, 243 (Data Network -195 , CCTV – 52).
- The No. of 4 ports ONT - 6672 (Data Network – 6250, CCTV- 422)
- Reduction of No. of cables from 20,000 to 6672
- 50% Saving on space
- 50% Saving on power and cooling
- Significant direct cost saving



Legacy vs POLAN Cost Comparison

Summary of Cost - GPON Based POLAN System Vs Traditional LAN				
Item No.	Item Description	POLAN	Traditional LAN	% Difference
		Offered Price (USD)	Offered Price (USD)	
1	Supply of Material	2,322,136.70	3,931,159.42	41%
2	Supply of Racks & Accessories	310,759.40	425,724.64	27%
3	Tools, Scaffolding & Consumables	26,110.23	81,521.74	68%
4	Detailed Engineering & Shop Drawings	228,901.08	498,188.41	54%
5	Installation	356,658.70	561,594.20	36%
6	Testing & Commissioning	63,175.60	117,753.62	46%
7	Active Equipment's	5,666,666.67	9,963,768.12	43%
8	Supply and Installation of Containment	815,217.39	2,251,811.59	64%
9	Add for Project Management + Back Office (10% of above Costs)	978,962.58	1,783,152.17	45%
	Total	10,768,588.35	19,614,673.91	45%



Legacy vs POLAN Cost Comparison

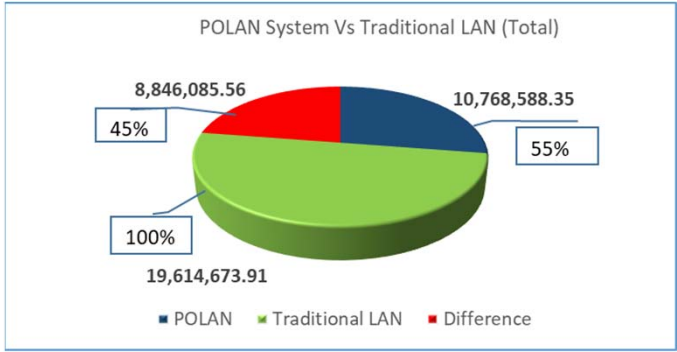
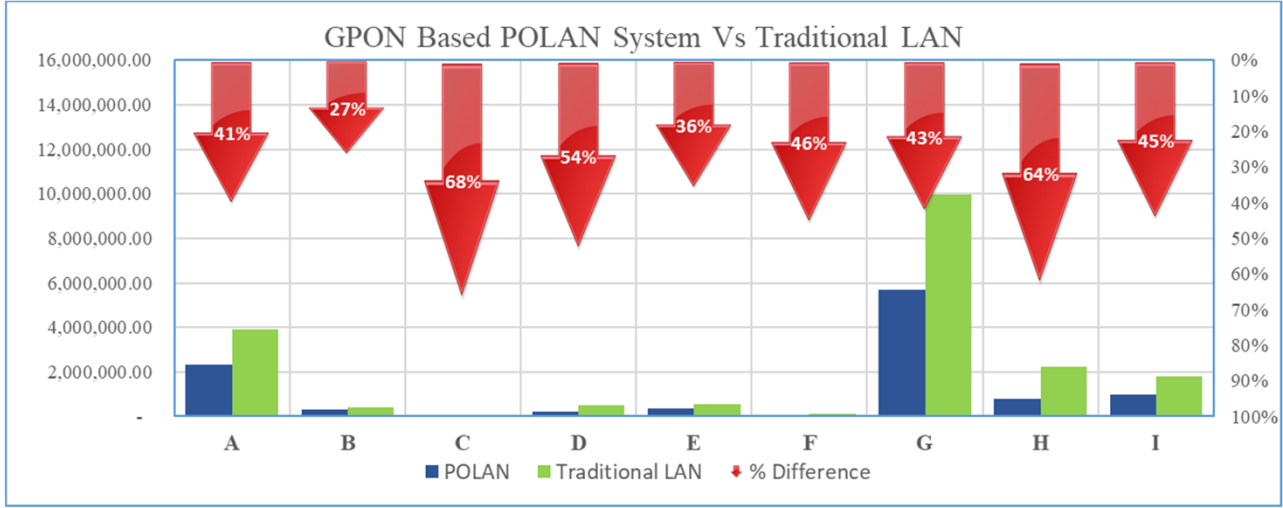

- A Supply of Material
- B Supply of Racks & Accessories
- C Tools, Scaffolding &
- D Detailed Engineering & Shop
- E Installation
- F Testing & Commissioning
- G Active Equipments
- H Supply and Installation of Containment
- I Add for Project Management + Back Office (10% of above Costs)

Outcomes from POLAN Deployment Efforts

- Strong financial justification for change
- Space and Power savings will lead to reduction of carbon foot print
- Proof of Concept to be deployed for acceptance
- Education and awareness among the property developers , end users etc.
- Certifications and opportunity to develop new skill set
- Forums / Seminars / Focus Groups to create awareness
- Institutionalization / Regulatory Frame work

POLAN is the future of in building networks. Telco operators are moving towards GPON based FTTH. Enterprise network will follow the trend soon.



2018 BICSI Fall Conference & Exhibition



Bicsi

Q&A

Thank You!

Para Munaweera
Senior Project Manager
Tamdeed Projects , Etisalat
United Arab Emirates
para@eim.ae
+971 50 5582628



2018 BICSI Fall Conference & Exhibition



Bicsi