

When a Network is No Longer Just a Network

Merging AV and Network Infrastructure

Karl Rosenberg
Extron



2018 BICSI Fall Conference & Exhibition



Bicsi

When a Network is No Longer Just a Network

Merging AV and Network Infrastructure

Karl Rosenberg
Extron



2018 BICSI Fall Conference & Exhibition



Bicsi

Agenda

- Networks
 - Supporting the Enterprise with Network Cable
 - Compression vs Uncompressed
- Video Signals
 - HDMI
 - USB 3.1 Type C
 - EDID
 - HDCP
 - IP Control
- CAT Cable for Video Over Twisted Pair
 - Shielded Cable
- Streaming Video
- Designs



Networks



2018 BICSI Fall Conference & Exhibition



Bicsi

What can you use a network for?

- Audio Signals
- VOIP
- Video
- Data
- Lighting
- VTC
- Control
- Multiple devices on a single network



VoIP

- VOIP – Voice over Internet Protocol is the delivery of voice communications over the Internet
- Public Switched Telephone Network (PSTN) is the worldwide topology that connects all telephones
- PSTN today is 99% digital with the Plain Old Telephone System (POTS) the only analog component remaining



Streaming Video

- Streaming is becoming more and more popular
- Movies, Concerts, Educational Lectures, Video Conferencing, and Events are becoming more common via Streaming Video
- It is easily accessible and a common method for content delivery with a variety of different devices



2018 BICSI Fall Conference & Exhibition



Bicsi

AV over IP

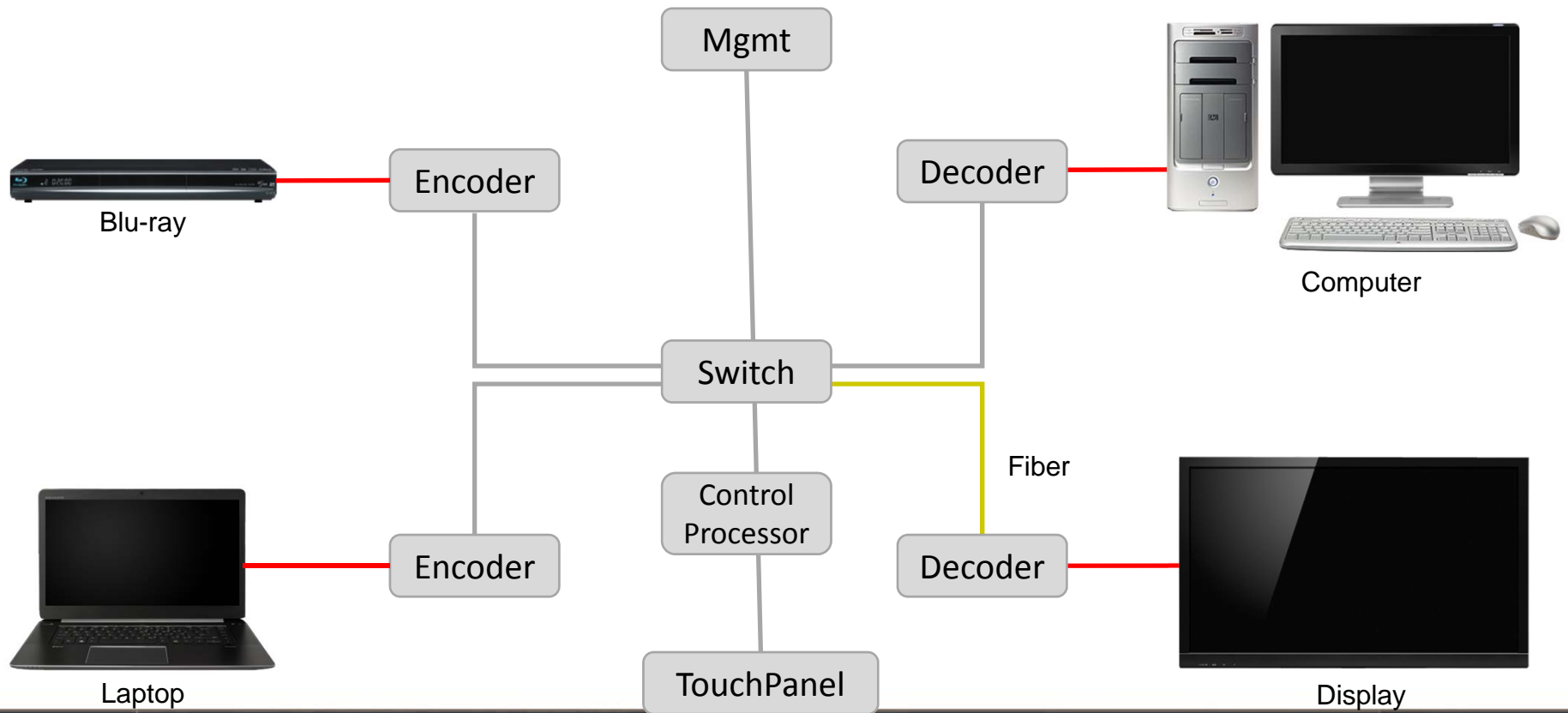

Recording and the “Flip Classroom”

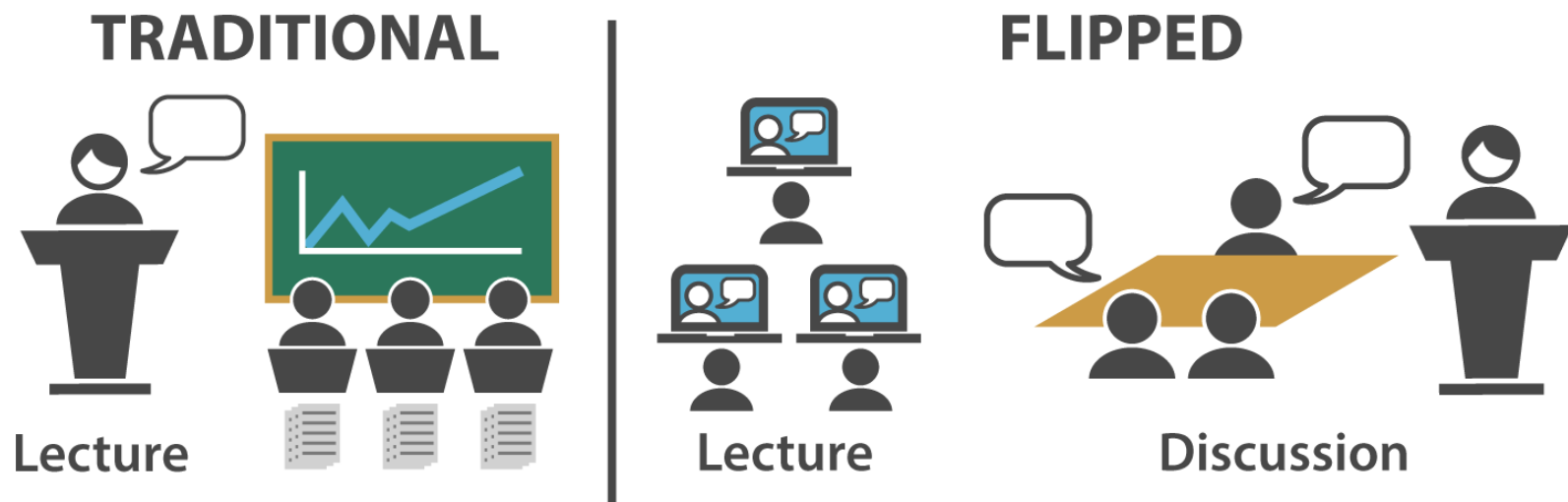

Data

- Access to files, folders, and content allows for greater collaboration and requires a secure network connection
- Live information and mission critical applications demand up to the second statistics and video data



Flight		HONG KONG
QF	085	AUCKLAND
NZ	008	HONG KONG
CX	104	KUALA LUMPUR
MH	148	KUALA LUMPUR
	1121	KUALA LUMPUR



2018 BICSI Fall Conference & Exhibition



Bicsi

Control

- More and more devices are capable of being controlled remotely over network connections
- Computers, Thermostats, Displays, Lights, Room Schedulers, Sound Systems, and Security Systems comprise the most commonly connected network devices and are used in a variety of applications



HDBaseT

- The HDBaseT Alliance, is a consumer electronic (CE) and commercial connectivity standard for transmission of uncompressed high-definition video (HD), audio, power, home networking, Ethernet, USB, and some control signals, over a common Ethernet (Cat5e or above) cable



2018 BICSI Fall Conference & Exhibition



Bicsi

Audio

- Audio expansion now occurs using network cables
- Signals are sent over the network to different devices with almost zero latency
- Dante enabled devices can send audio signals over CAT5e, CAT6, or fiber optic cables



Multiple Types of Devices

- Networks need to be capable of handling multiple types of devices and environments where BYOD is common



LED Lighting

- Control and power lighting fixtures via POE
- Energy efficient LEDs provide cost savings, easy installation, and enhanced flexibility with projects of all sizes

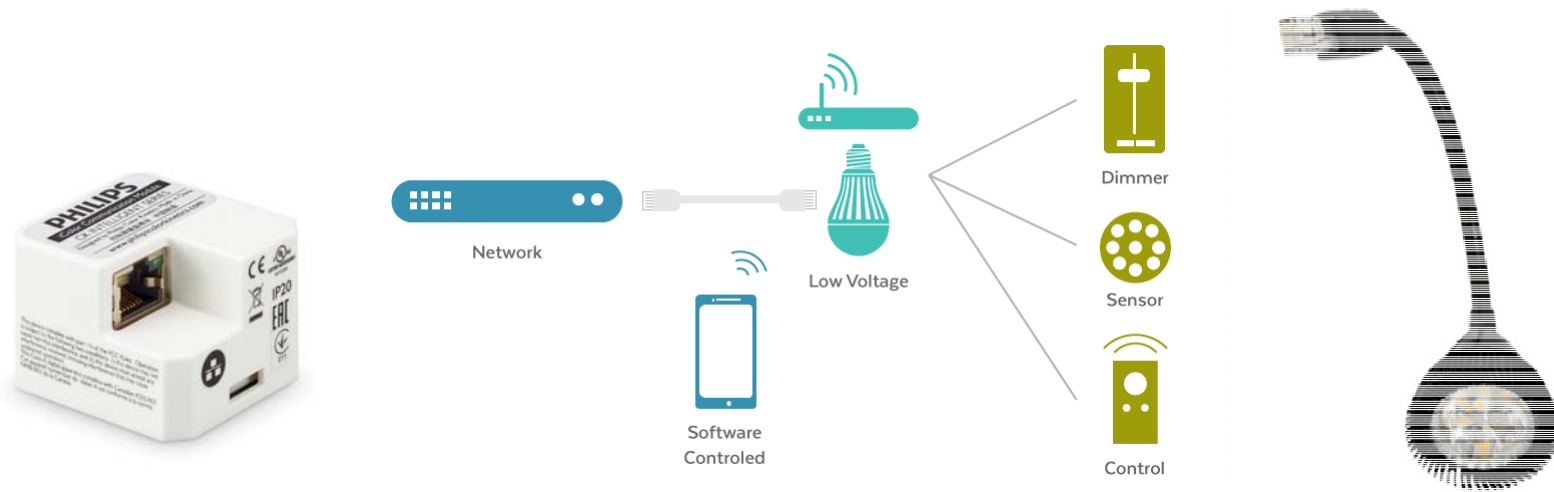

Wireless

- Devices that don't have physical connections rely on wireless connectivity to send and receive Audio Visual data



The Biggest Question

- Bandwidth and Data Rate
- 1Gigabit E
- 10 Gigabit E
- 40 Gigabit E

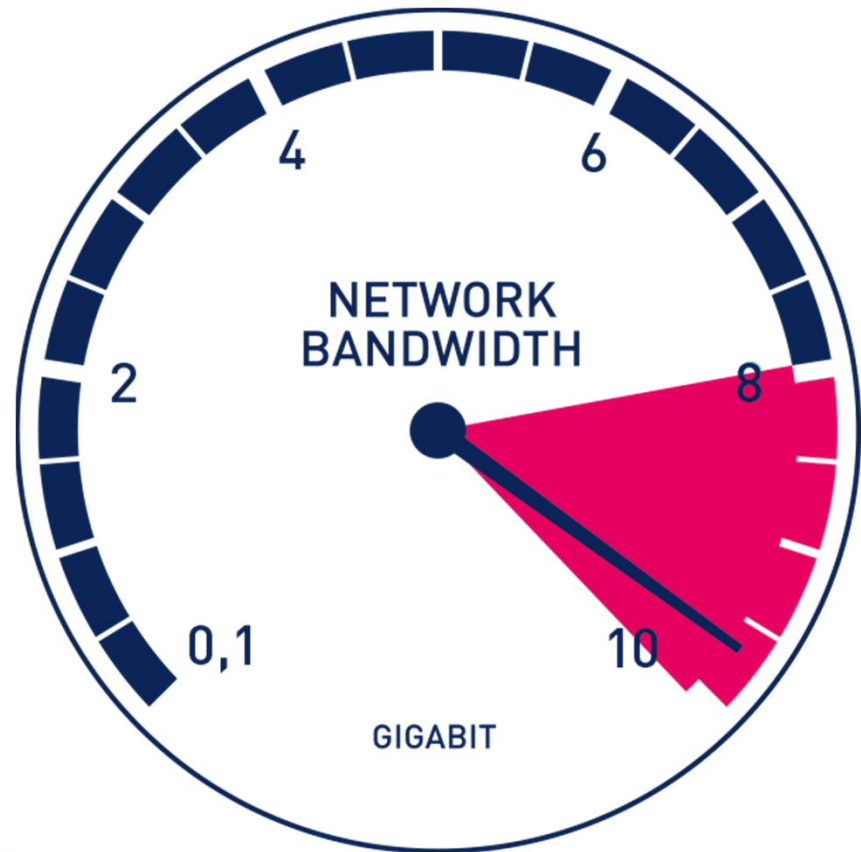

Video Signals



2018 BICSI Fall Conference & Exhibition



Bicsi

Digital Signals – HDMI

- HDMI is an uncompressed digital video signal
 - Designed for the consumer market
- Adds support for:
 - Audio – stereo and surround formats (PCM, Dolby, DTS)
 - YCbCr color space – optional
 - HDCP – optional but recommended
 - CEC – Consumer Electronic Control – optional
 - InfoFrames



HDMI – Connectors, Distance, Communication

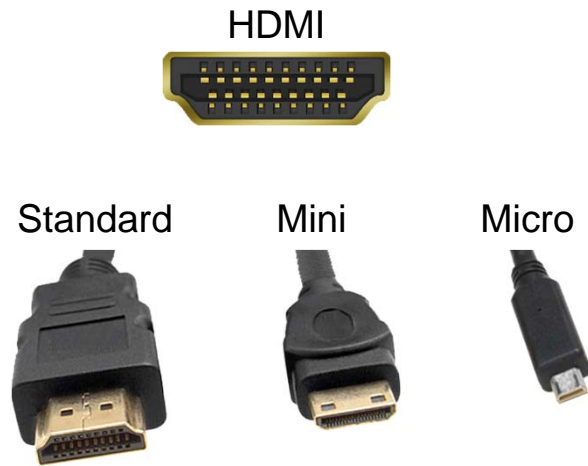

Mini

- Added in HDMI version 1.3

Micro

- Max resolution 1080p

HDMI specification does not define transmission distance

- Cable performance has a direct bearing on distance



EDID information is sent from the display to the source

- Required by HDMI specifications

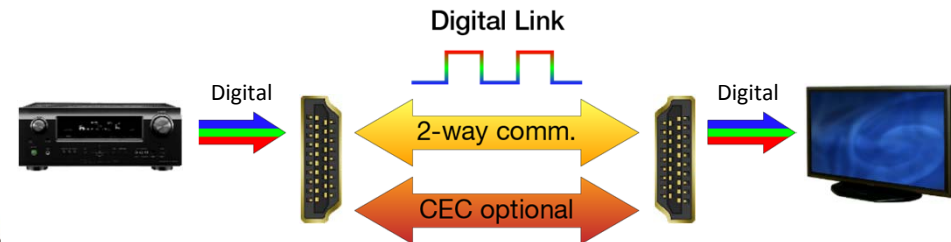

2018 BICSI Fall Conference & Exhibition



Bicsi

Resolutions

- Old Resolutions
- New standard 1080p
- Headed to 4K/UHD and 8K





2018 BICSI Fall Conference & Exhibition



Bicsi

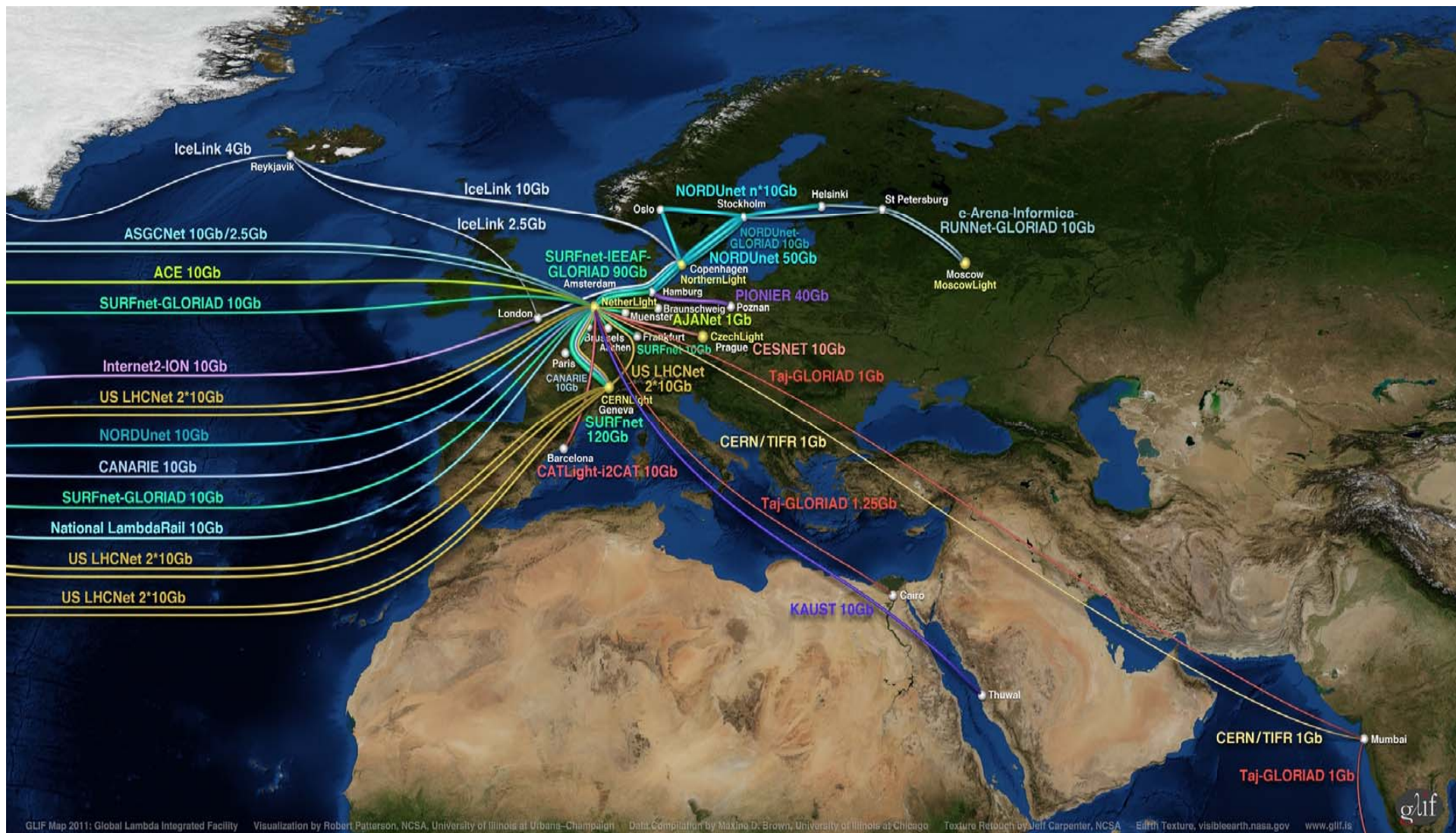

GLIF Map 2011: Global Lambda Integrated Facility Visualization by Robert Patterson, NCSA, University of Illinois at Urbana-Champaign Data Compilation by Maxine D. Brown, University of Illinois at Chicago Texture Retouch by Jeff Carpenter, NCSA Earth Texture, visibleearth.nasa.gov www.glif.is glif

2018 BICSI Fall Conference & Exhibition



2018 BICSI Fall Conference & Exhibition



Bicsi

4K Signal Parameters

- 4K DCI is 4096x2160
 - Four times the resolution of 2K DCI
 - Targeted towards digital cinema
- 4K refresh rates
 - Varies – 24 Hz up to 60 Hz
- Color bit depth
 - 8-Bit, 10-bit, and 12-bit
- Aspect Ratio
 - 17:9 – same as 2K

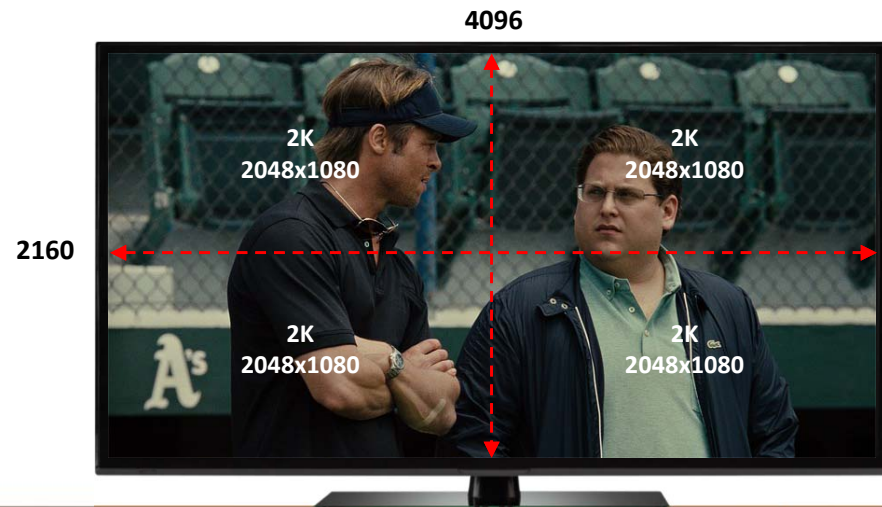
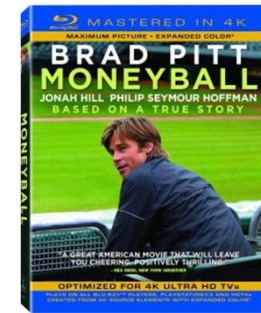

Ultra HD Video Signal Parameters

- Ultra HD is 3840x2160
 - Four times the resolution of 1080p
 - Targeted towards consumer and broadcast markets
- Ultra HD refresh rates
 - Varies – 24 Hz up to 60 Hz
- Color bit depth
 - 8-Bit, 10-bit, and 12-bit
- Aspect Ratio
 - 16:9 – same as 1080p

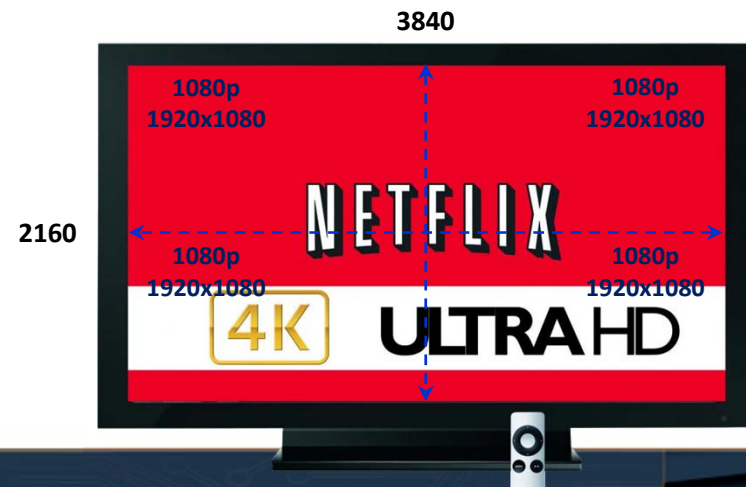

4K and Ultra HD Resolution Comparison

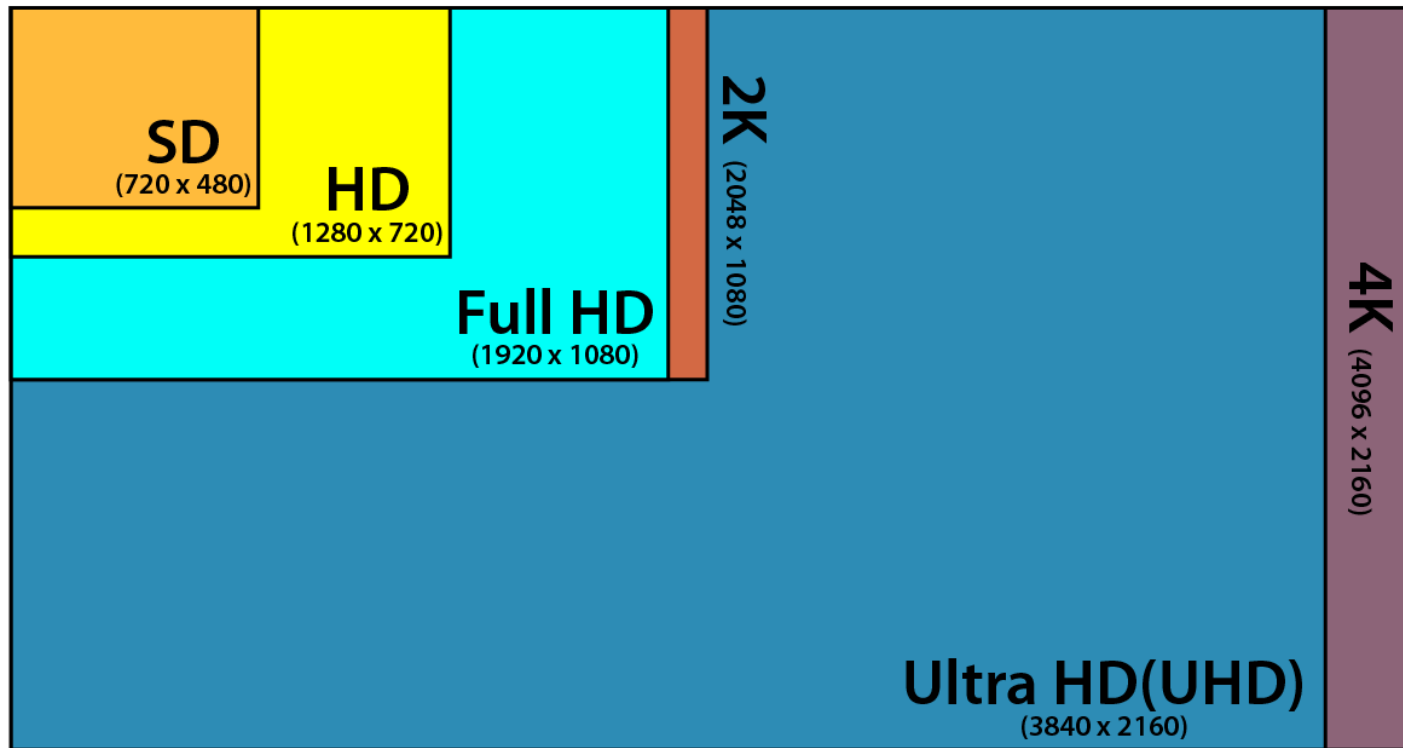

8K Ultra HD Video Signal Parameters

- 8K Ultra HD Super Hi-Vision is 7680x4320
 - 16 times the resolution of 1080p
 - Designed to be superior to the human visual system
 - Shoots at 2x the rate of normal video so movement is smooth and realistic
- Aspect Ratio
 - 16:9
- 8K refresh rates
 - Varies – up to 120 Hz
- Color bit depth
 - 8-bit, 10-bit, and 12-bit
- Chroma sampling
 - 4:4:4, 4:2:2, or 4:2:0



HDMI 2.0 and HDMI 2.1

- New functionality includes
 - Enables transmission of HDR – High Dynamic Range video
 - Signaling speed to 18 Gbps
 - 4K@50Hz/60Hz, (2160p)
 - 4 times the clarity of 1080p/60 video resolution
 - Up to 32 audio channels with up to 1536 kHz audio sample frequency
 - 32 channels @ 48kHz each
 - Dual video streams on same screen, 4 audio streams
 - Support widescreen 21:9 format
 - Dynamic sync of audio/video
 - CEC extensions with expanded control via single point
- Backwards compatible

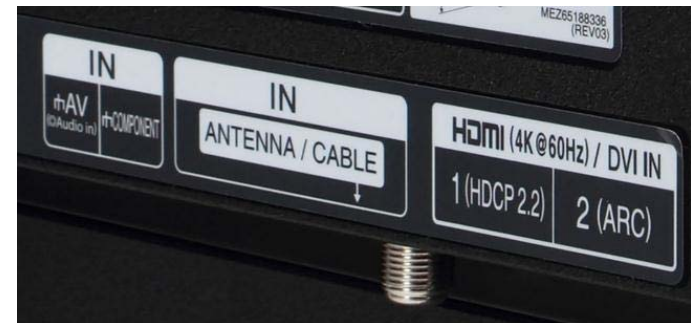

Digital Signals – USB

- Over the years speeds have increased and USB supports video and audio transfer
 - USB 2.0 - 480 Mbps
 - USB 3.0 - 5 Gbps
 - USB 3.1 -10 Gbps
- Providing additional options for transporting video and audio

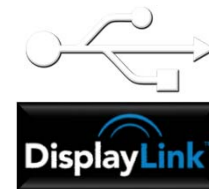

2018 BICSI Fall Conference & Exhibition



Bicsi

USB Type-C

- Send Data, Video, Audio, and Power
- Latest, high speed, reversible USB
- 10Gbps data rate (V3.1), V3.0 = 5Gbps
- Deliver up to 100 watts! Devices negotiate...
- Supports “alternate modes” ... like DisplayPort
- “...beyond 20 Gbps in the future.”
 - Pres. USB-IF



EDID – Extended Display Identification Data

- EDID contains the following information:
 - Sink identity – device type, model number, etc.
 - Sink capability – video/audio
 - Video timing parameters, color space, audio formats, etc.
- EDID also defines the data structure
 - Block 0 – 128 byte of hexadecimal data
 - Block 1 – additional 128 byte of hexadecimal data
 - Block 1 was added in version 1.3

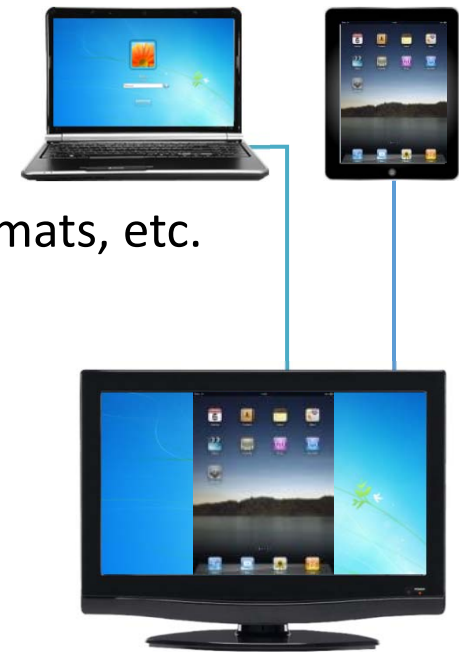

EDID – Sequence

1. Power on PC or activate external graphics card
2. Computer requests EDID data from display
3. Display sends EDID data to computer
4. Computer attempts to match display parameters

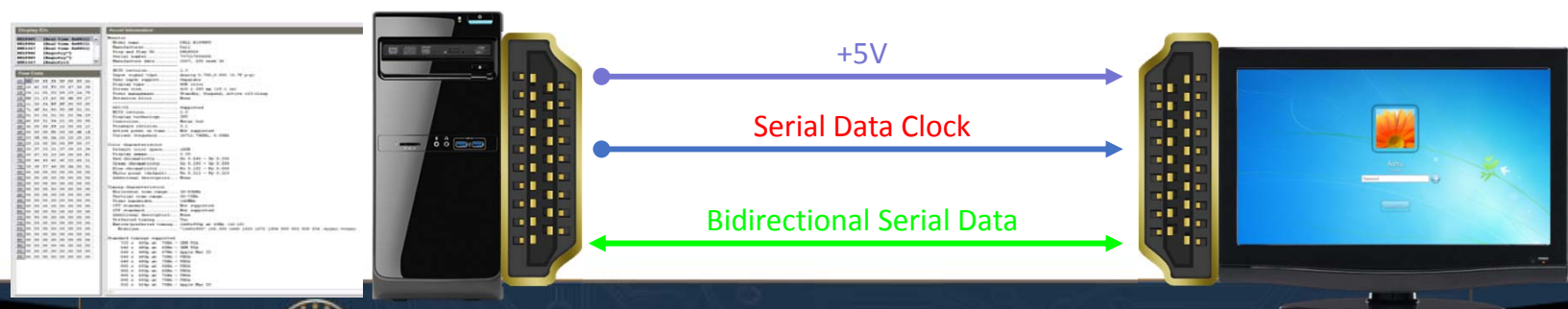

HDCP – High-bandwidth Digital Content Protection

- HDCP protocol is a 3-phase process
 - Authentication
 - Content encryption
 - Renewability
- This can take a few moments depending on the number of downstream devices



DVD Player



Blu-ray with HDMI



2018 BICSI Fall Conference & Exhibition



Bicsi

HDCP Handshakes

- I/O authentication

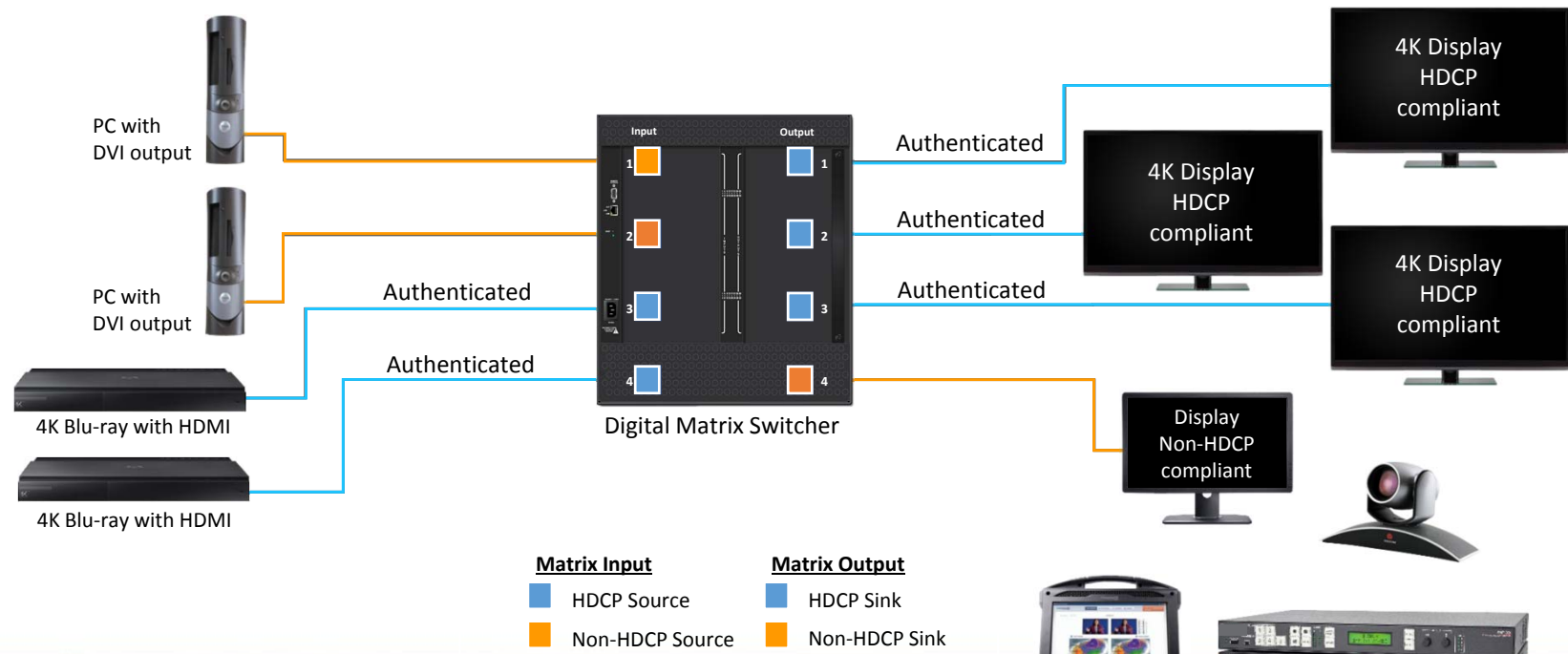

HDCP Handshakes With Products That Are Not HDCP Compliant

- Visual confirmation

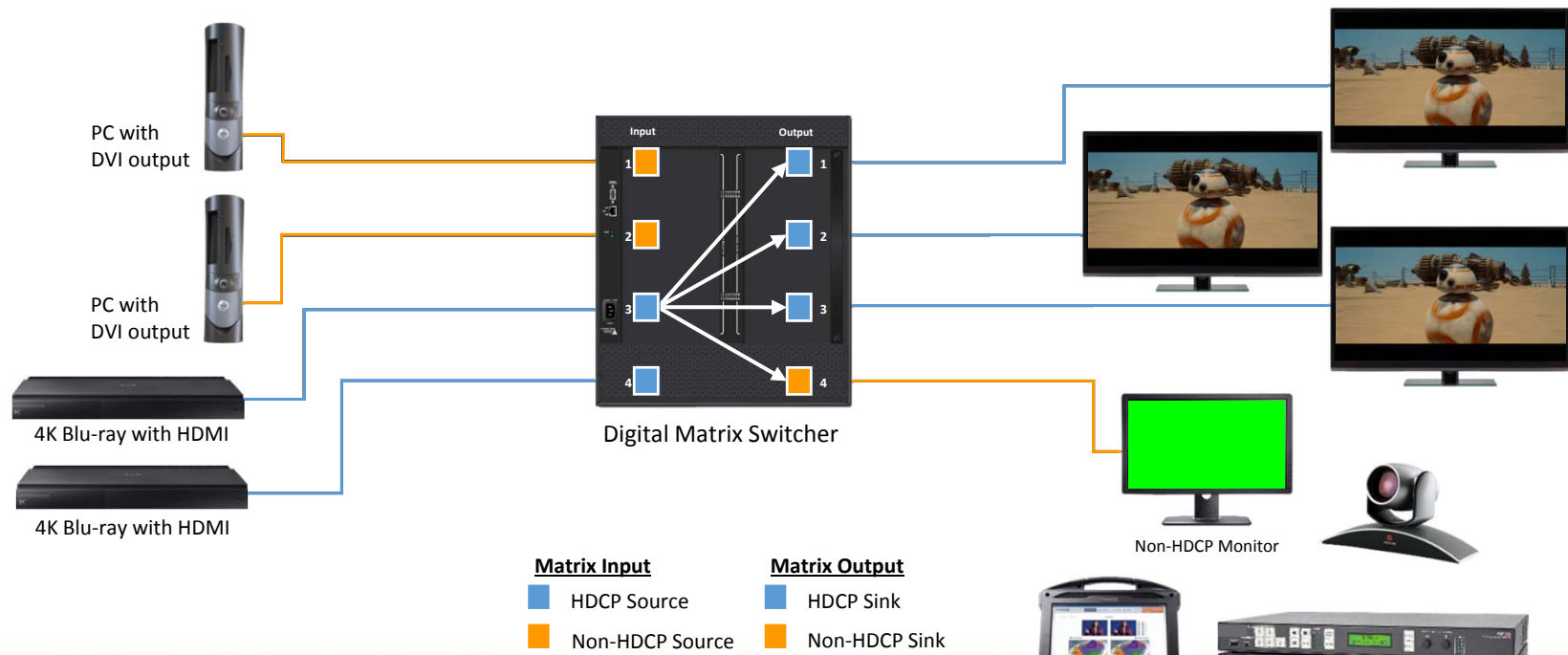

2018 BICSI Fall Conference & Exhibition



Bicsi

Backward Compatibility With HDCP 1.x

- HDCP 1.x source to HDCP 2.2 displays
 - Most HDCP 2.2 displays accept HDCP 1.x encrypted content

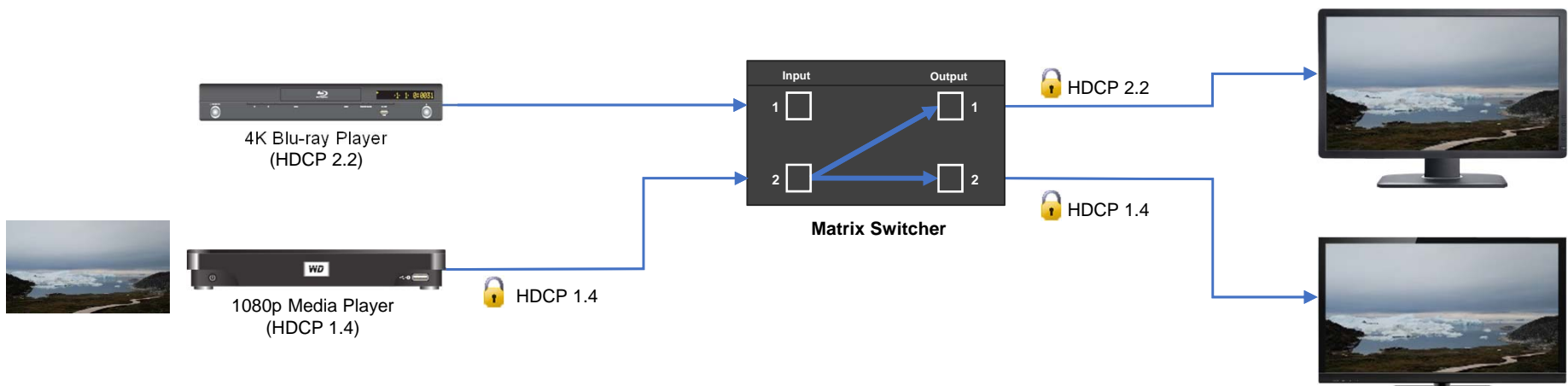

Backward Compatibility With HDCP 1.x

- HDCP 2.2 source to HDCP 1.x displays – content marked “High Value”
 - An HDCP 2.2 compliant source will not transmit high value protected content to HDCP 1.x displays

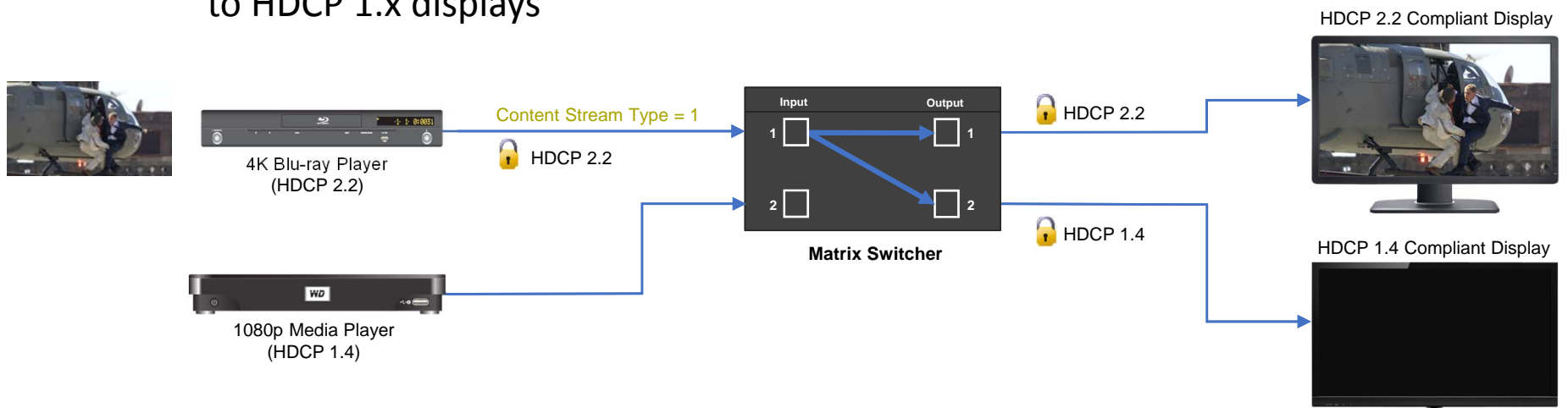

Backward Compatibility With HDCP 1.x

- HDCP 2.2 source to HDCP 1.x displays – content **not** marked “High Value”

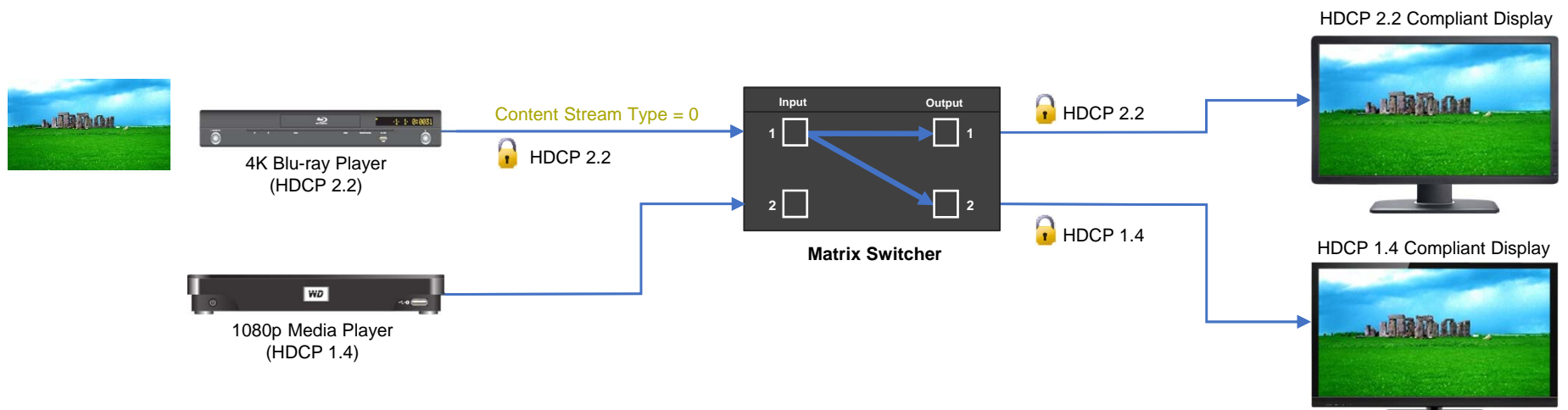

Uncompressed Video Over Twisted Pair



2018 BICSI Fall Conference & Exhibition



Bicsi

Twisted Pair Transmission

- Distance
 - 328 feet (100 meters) between endpoints

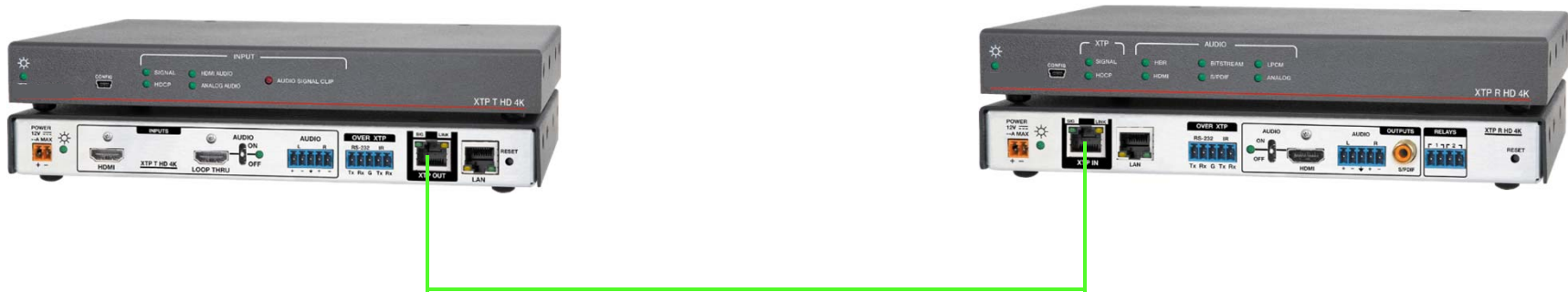

Why Use Twisted Pair?

- One twisted pair cable can carry multiple signals
 - Video
 - Audio
 - Bidirectional RS-232 control and IR
 - Ethernet
 - Remote Power



CAT Cable

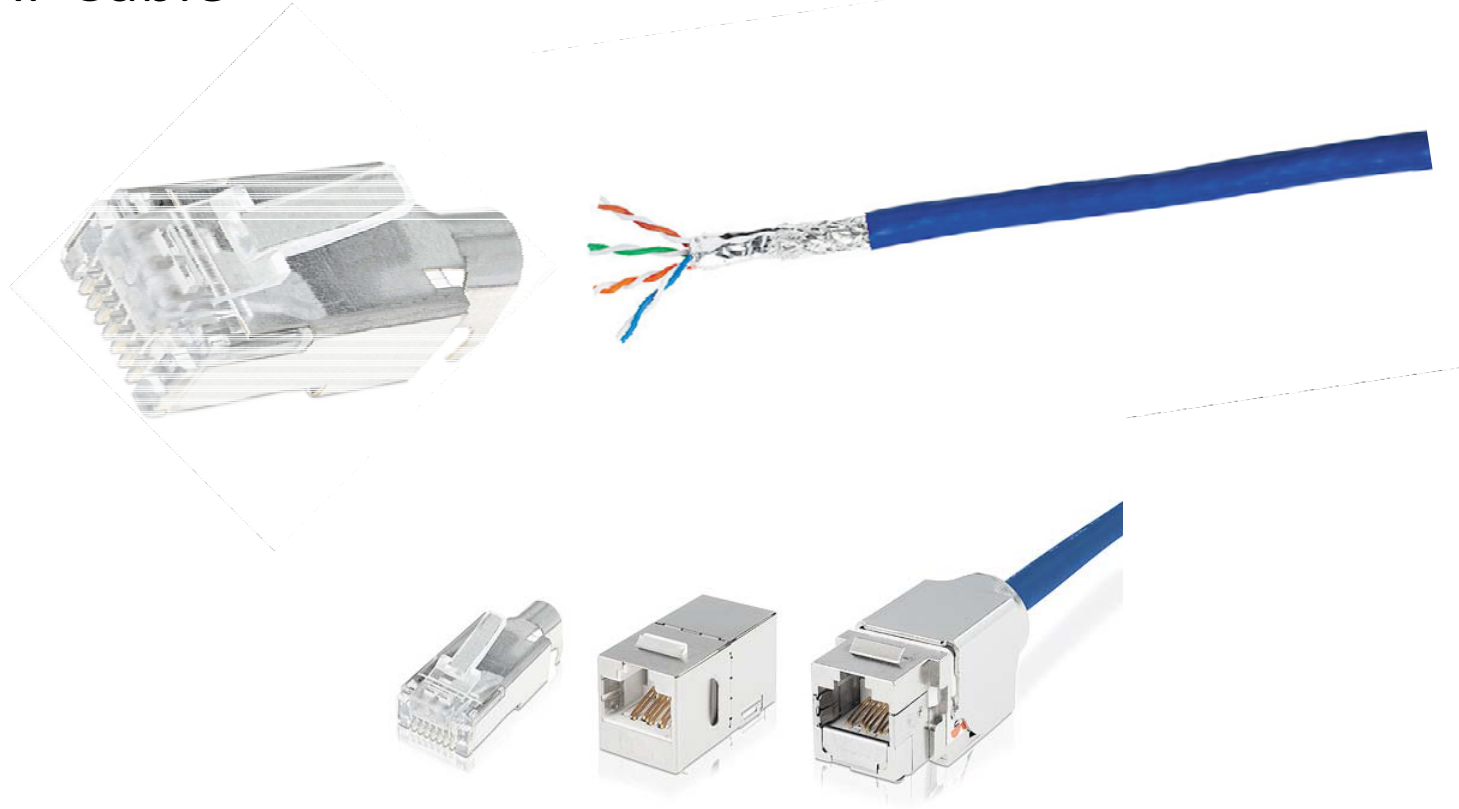

2018 BICSI Fall Conference & Exhibition



Bicsi

Twisted Pair Transmission

- Cable
 - Supports CATx cable
 - Solid conductor, shielded twisted pair cable with shielded connectors should always be used
 - Skew-free cable **should not** be used with XTP Systems



Twisted Pair Signal Transmission

- Shielded cable protects against outside interference from:
 - Air conditioning units
 - Power from adjacent cabling
 - Crosstalk from other cables or within the same cable
 - Radio interference from walkie-talkies
- Symptoms of noisy environments
 - Image drop-out or flashing
 - No image at all

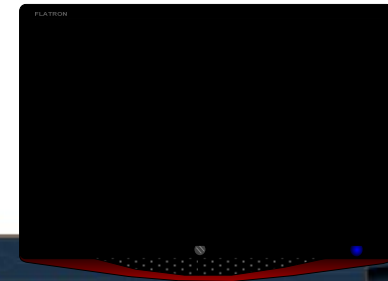
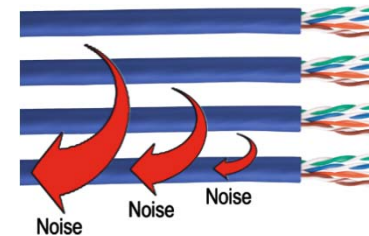

Twisted Pair Shielding

- Different types of twisted pair shielding

Cable Name	Outer Shielding	Individual Pair Shielding
U/UTP	None	None
F/UTP	Foil	None
U/FTP	None	Foil
S/FTP	Braided	Foil
SF/UTP	Braided & Foil	None

U/UTP

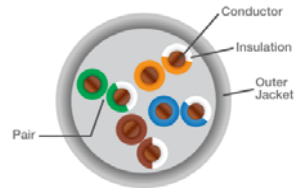

F/UTP

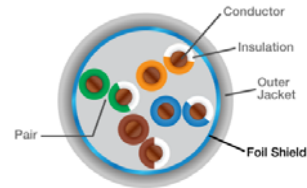

U/FTP

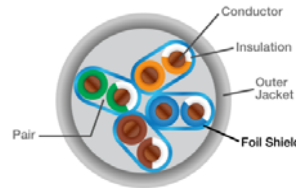

S/FTP

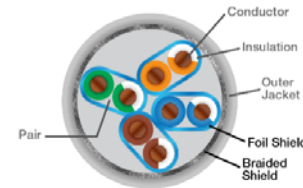

SF/UTP

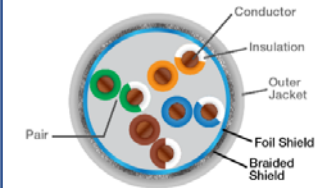

Twisted Pair Signal Transmission

- Types of Category cable

Cable	Gauge	Conductor	Outer Shield	Pair Shielding	Required Bandwidth	Crosstalk Loss
CAT 5e (U/UTP)	24	Solid	None	None	100 MHz	~27dB
CAT 5e (F/UTP)	24	Solid	Foil	None	100 MHz	~27dB
CAT 6 (U/UTP)	24-23	Solid	None	None	250 MHz	~37dB
CAT 6 (STP)	24-23	Solid	Foil	None	250 MHz	~37dB
CAT 6a (U/UTP)	24-23	Solid	None	None	500 MHz	~37dB
CAT 6a (F/UTP)	24-23	Solid	Foil	None	500 MHz	~37dB
CAT 6a (U/FTP)	24-23	Solid	None	Foil	500 MHz	~37dB
CAT 6a (SF/UTP)	24	Solid	Braid and Foil	None	500 MHz	~37dB
CAT 7 (S/FTP)	24	Solid	Braid and Foil	Foil	600 MHz	~60dB
CAT 7a (S/FTP)	24	Solid	Braid and Foil	Foil	1 GHz	~60dB



Twisted Pair Installation

- Cable infrastructure and patch points
 - Up to 2 patch points recommended

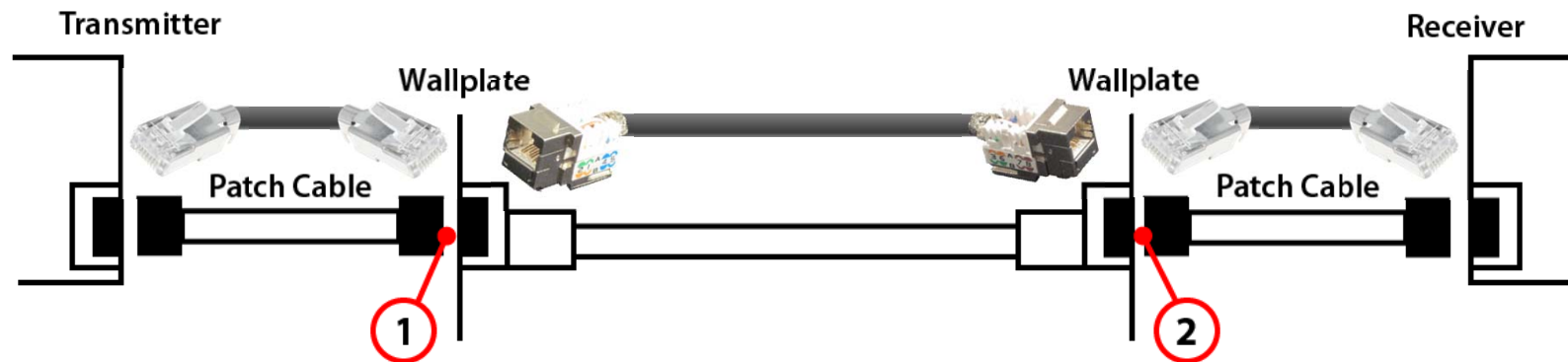

Typical scenario for AV connectivity



2018 BICSI Fall Conference & Exhibition

Bicsi

IP Control

- Devices on the Network are capable of communication, configuration, and control
- Devices will often have internal webpages for configuration

Touchpanel for control
IP Address 192.168.254.200



Digital Matrix Processor w/ VoIP
IP Address 192.168.254.100



2018 BICSI Fall Conference & Exhibition



Bicsi

Room Scheduling

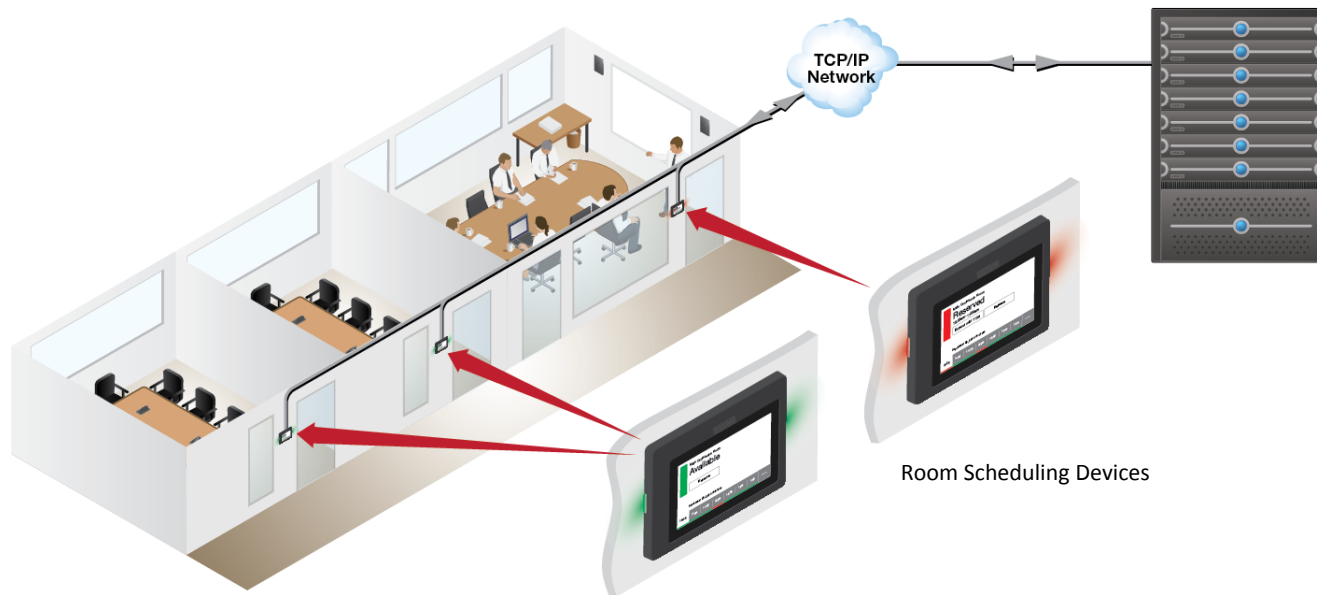

Room Management

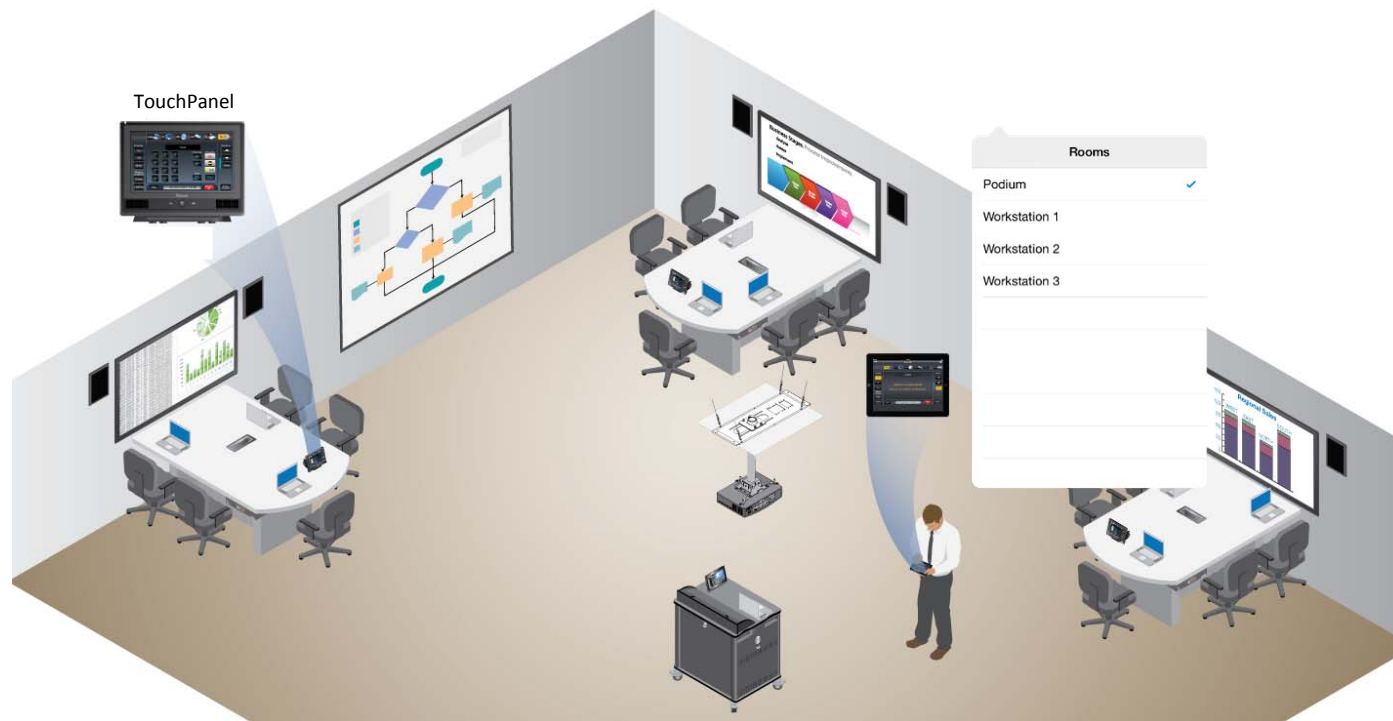

Wireless Video Applications

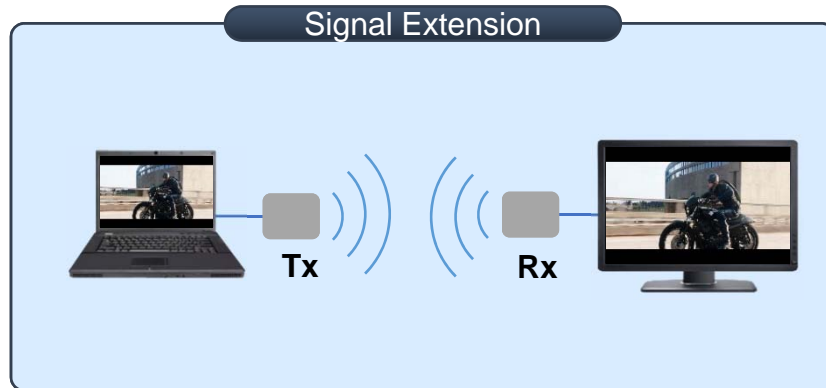

- Point-to-point applications where source video signal is converted to a modulated RF signal for wireless transmission to a receiver connected to a display

- BYOD applications where computing device encodes and transmits video content over a Wi-Fi network to a receiver connected to a display



Radio Frequency Spectrum

- 500MHz to 5GHz balances capacity and range
- Transmits through common obstacles, such as walls, with low to moderate loss

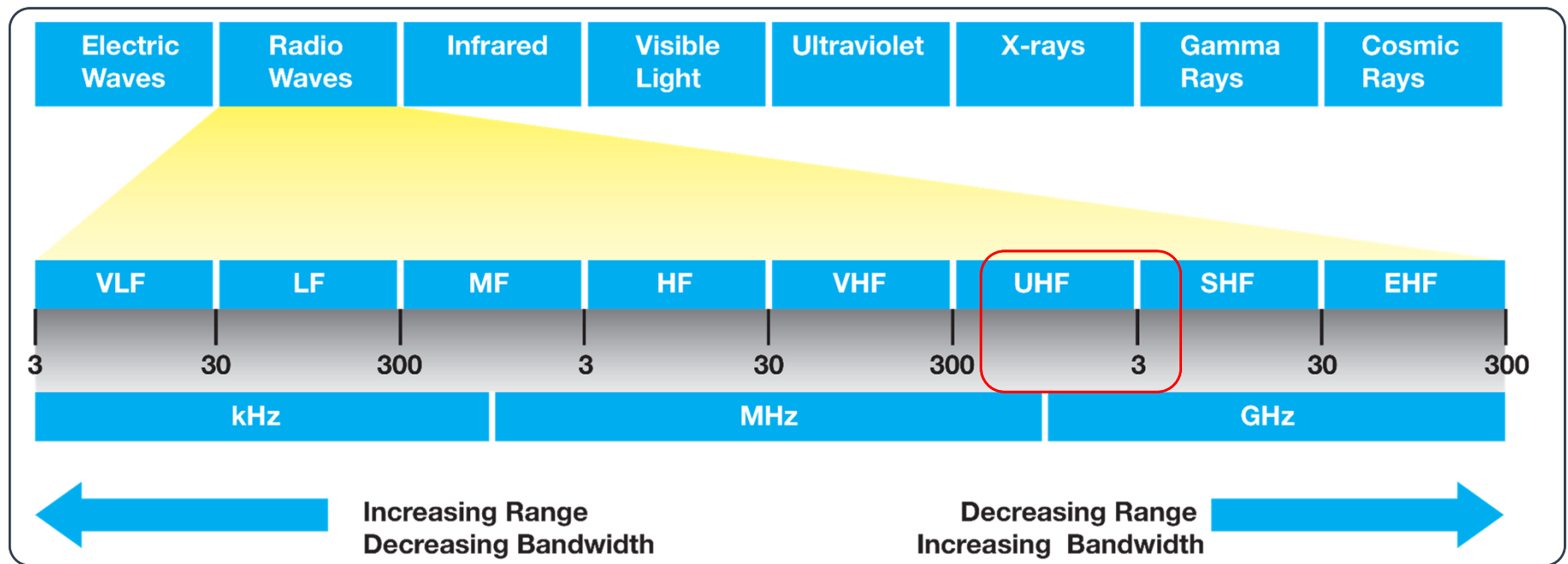

Radio Frequency Spectrum

- 60 GHz used for higher data carrying capacity
 - Cannot penetrate solid objects
 - Short range

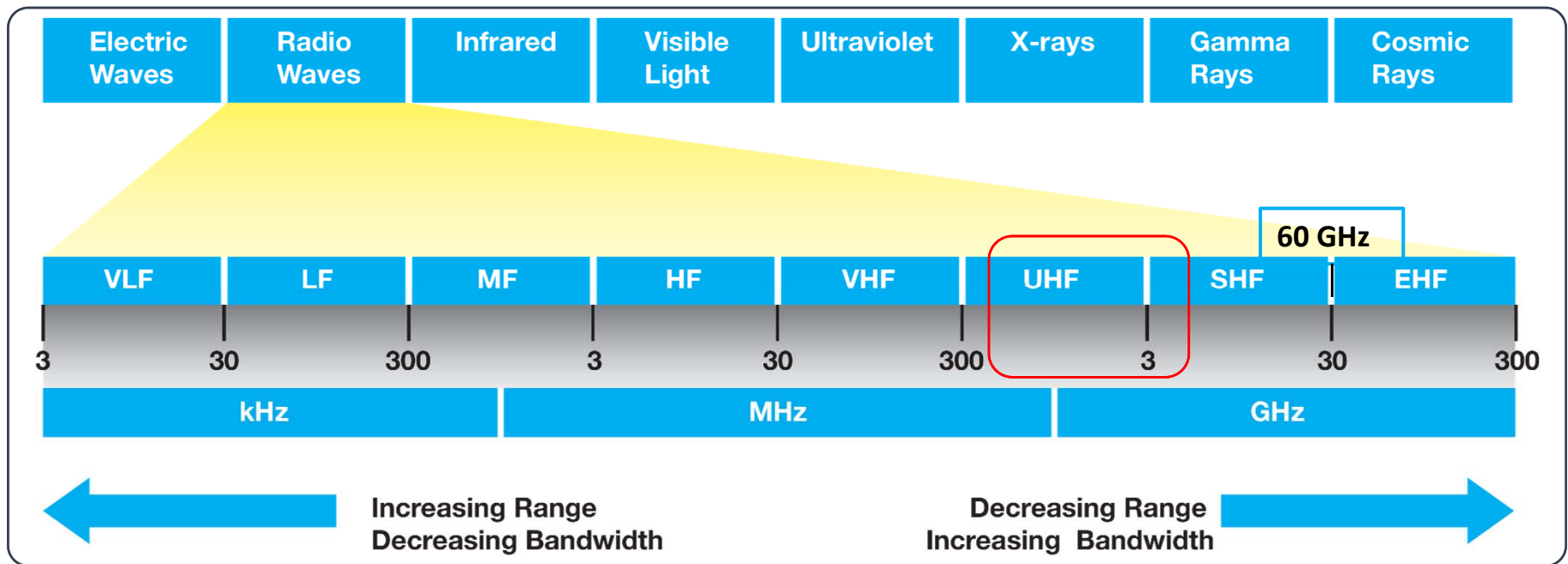

2018 BICSI Fall Conference & Exhibition



Bicsi

Wireless Technologies

Compressed and Uncompressed



2018 BICSI Fall Conference & Exhibition



Bicsi

MIMO – Multiple-input, Multiple-output

- Smart antenna technology using multiple antennas on both transmitter and receiver to improve performance
 - Spatial multiplexing
 - Same frequency, different information on each antenna
 - Each signal travels multiple paths from Tx to Rx
 - DSP – Digital Signal Processor in receiver separates the signals into parallel paths and restores the original signal



Proprietary Wireless Protocols

Wireless Interface	Frequency Band	Computing Hardware Required	Uncompressed Video
AirPlay	Wi-Fi	Apple Products	No
Chromecast	Wi-Fi	PC, tablet, smartphone	No
Miracast	Wi-Fi	PC, tablet, smartphone	No
WiDi	Wi-Fi	Intel Products	Yes
WiGig	Wi-Fi, 60 GHz	PC, tablet, smartphone	Yes
UWB	3.1 – 10.6 GHz	None	Yes
WHDI	5 GHz	None	Yes
WirelessHD	60 GHz	None	Yes



1 to 1 Link

- Supports robust wireless extension up to 100 feet (30m)
- Includes normally anticipated obstructions – walls, furniture

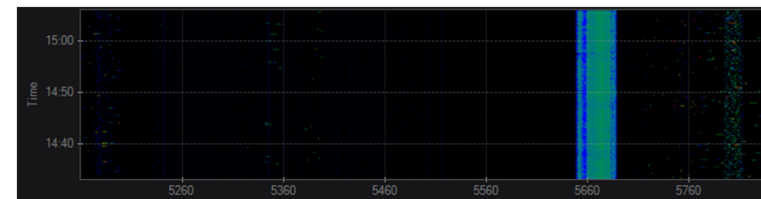
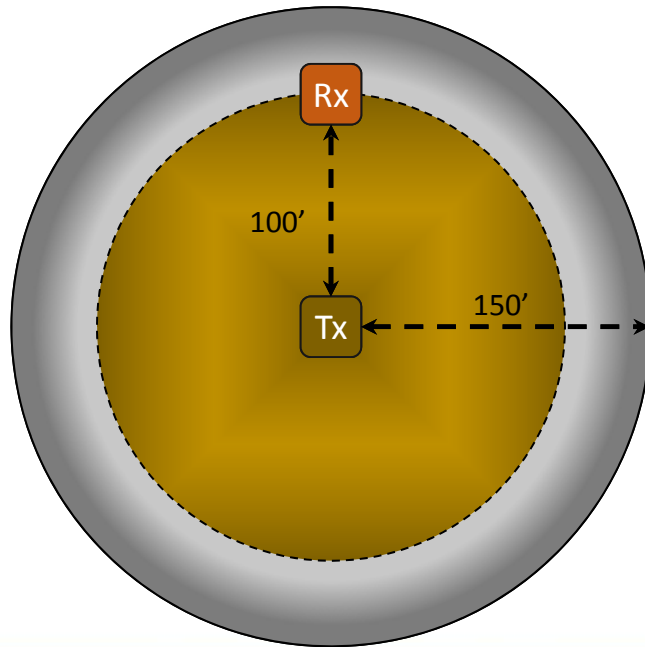

Channel Use

- Multiple systems can operate within same 150 foot (45m) radius
 - Recommend no more than 4 systems overlap

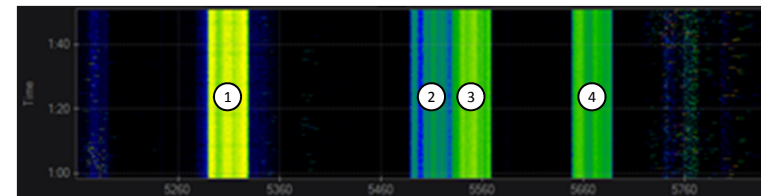
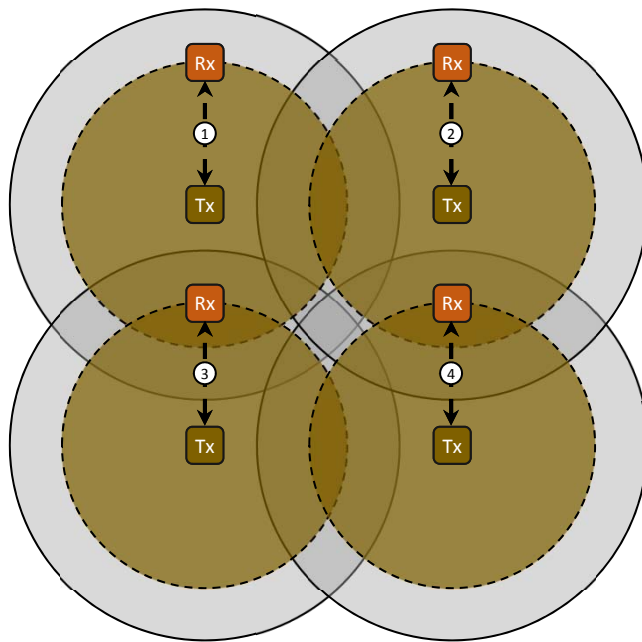

Streaming Video



2018 BICSI Fall Conference & Exhibition



Bicsi

Why Streaming?

- Uncompressed content is too large to send over a network

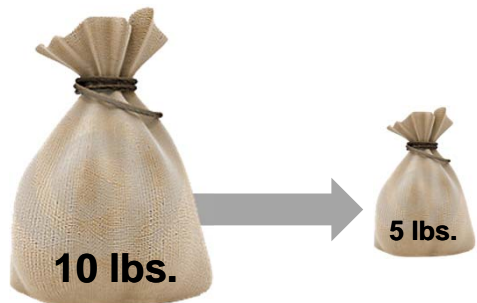

Signal	Sampling	Bits per Color	Horizontal Pixels	Vertical Lines	Frames per Second	Approx. Data Rate
NTSC	(4:2:2)	8	720	486	30	126 Mbps
ATSC 720p	(4:2:2)	10	1280	720	60	1.5 Gbps
ATSC 1080p	(4:2:2)	10	1920	1080	60	2.97 Gbps
XGA	(4:4:4)	8	1024	768	60	1.1 Gbps
SXGA+	(4:4:4)	8	1400	1050	60	2.1 Gbps
WUXGA	(4:4:4)	8	1920	1200	60	3.3 Gbps



126 Mbps



100 BaseT Ethernet

100 BaseT Networks do not support streaming uncompressed NTSC video



3.3 Gbps



Gigabit Ethernet

Gigabit Networks do not support streaming uncompressed computer graphics



2018 BICSI Fall Conference & Exhibition



Application Focus – Compression

- Design focus on core application requirements
 - Viewing expectations
 - Connection bandwidth
 - Interaction or workflow
- Select components
- Focus on one or two performance areas

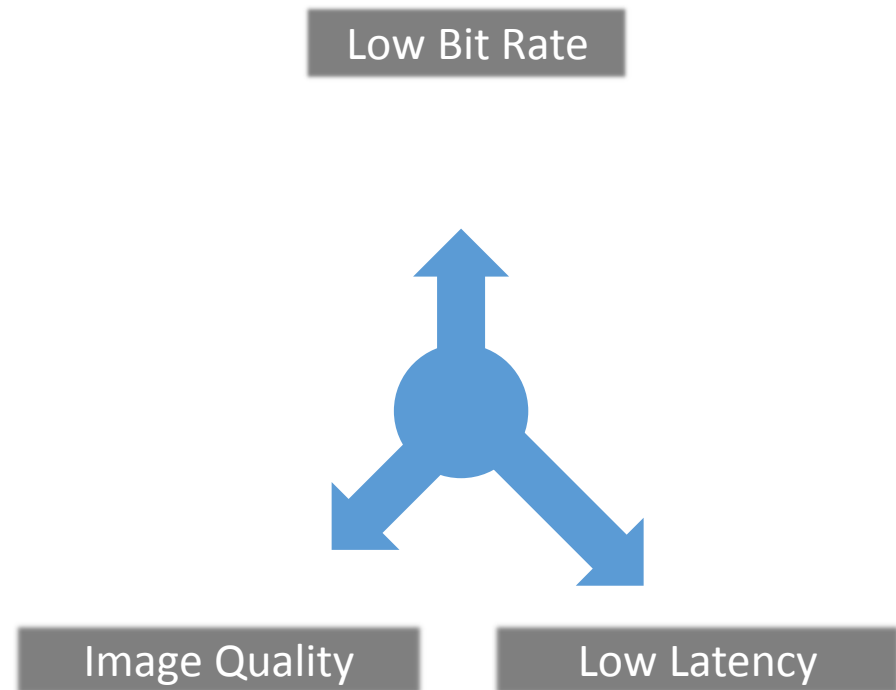

Streaming Video

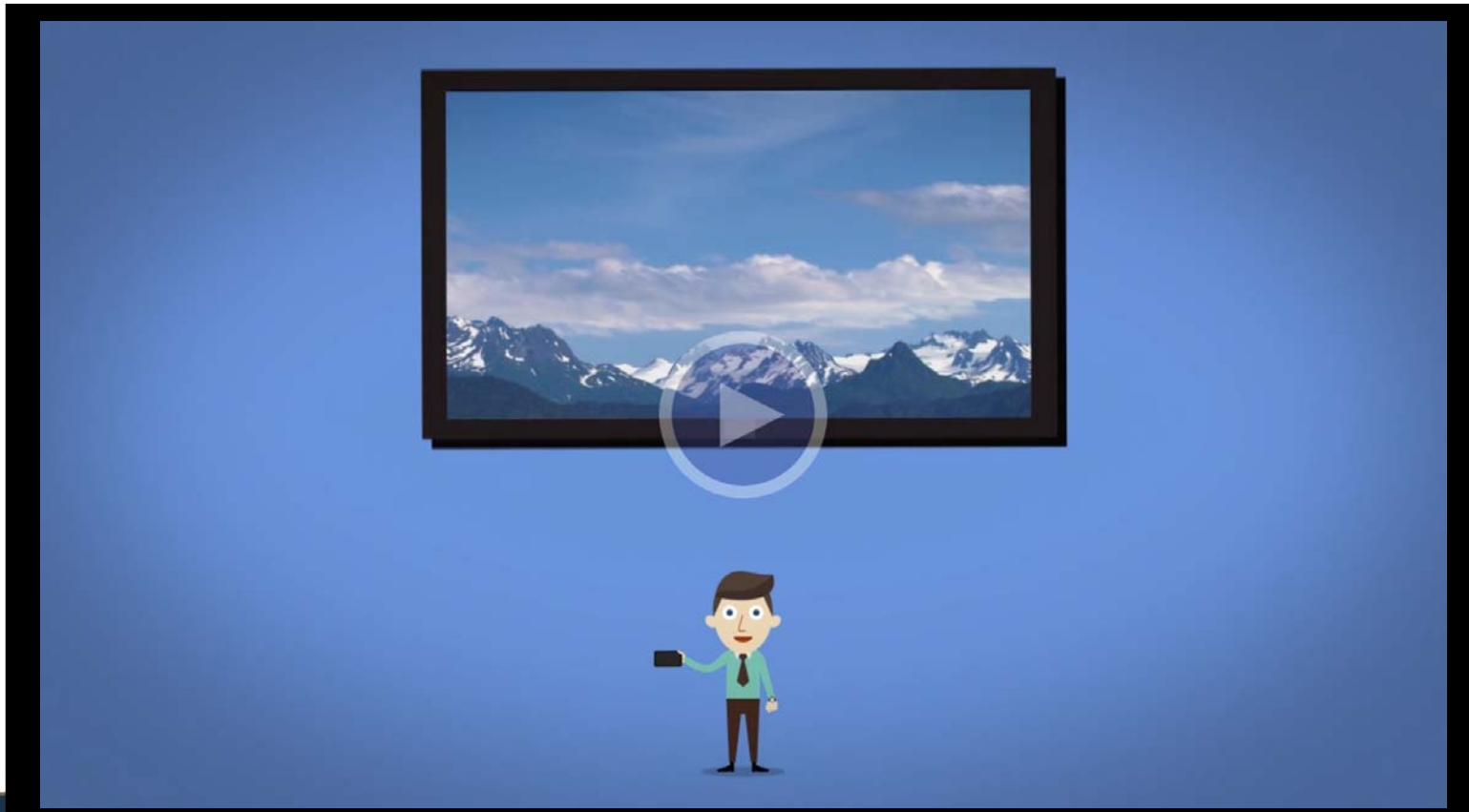

2018 BICSI Fall Conference & Exhibition



Bicsi

Steps in Streaming Media

- Encode
- Transport
- Decode

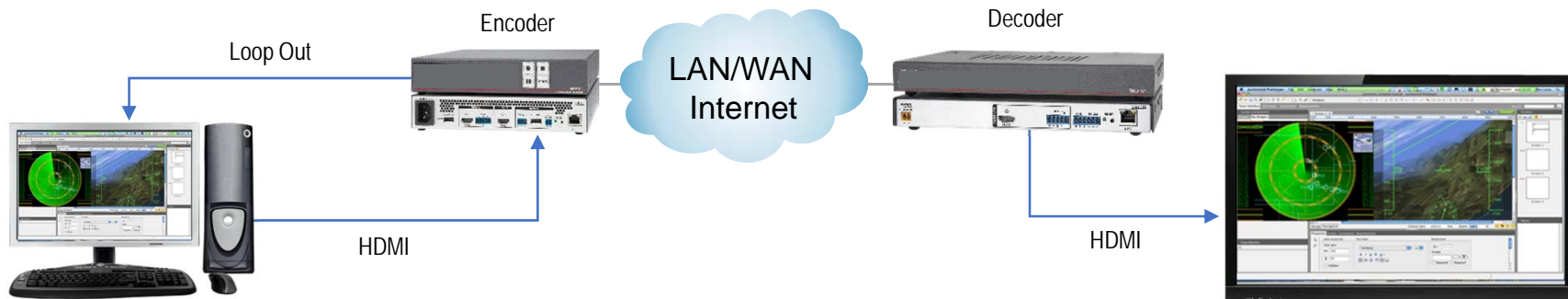

Encoding Process

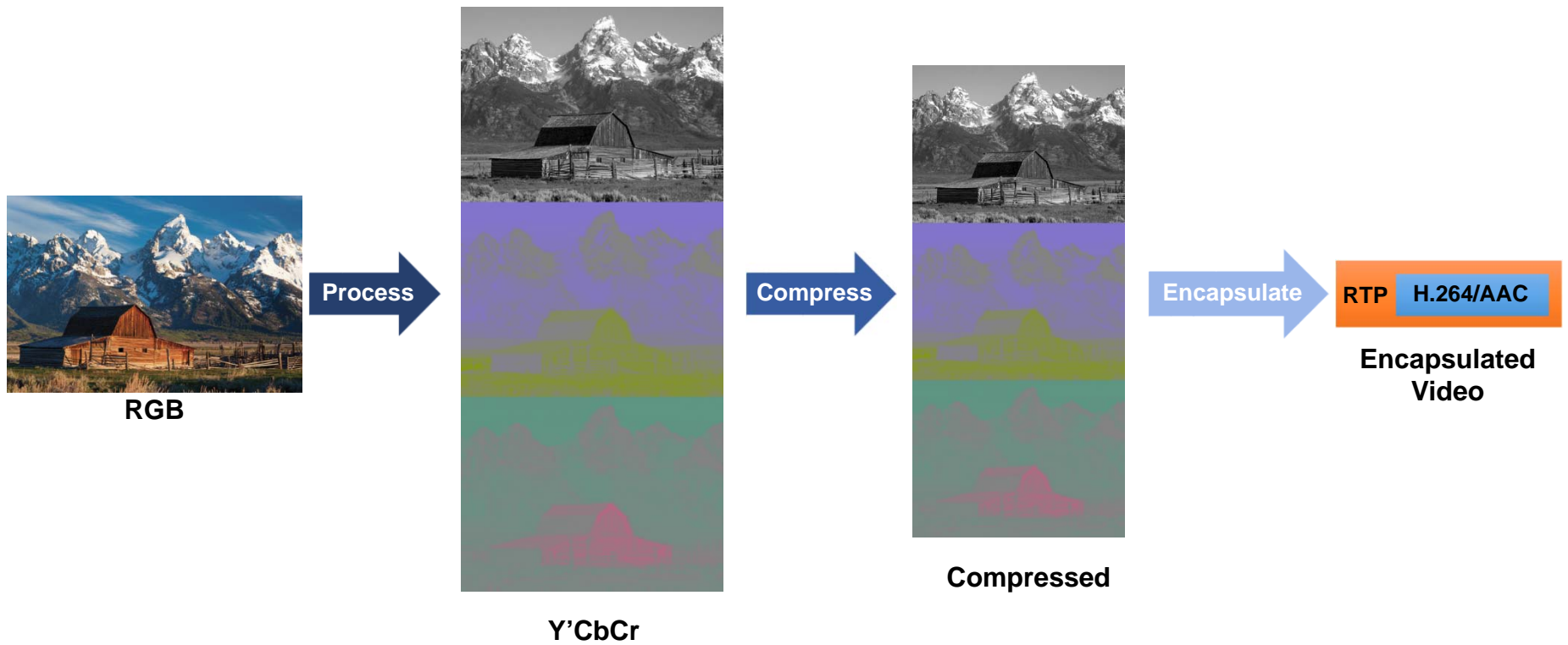

Decoding Process

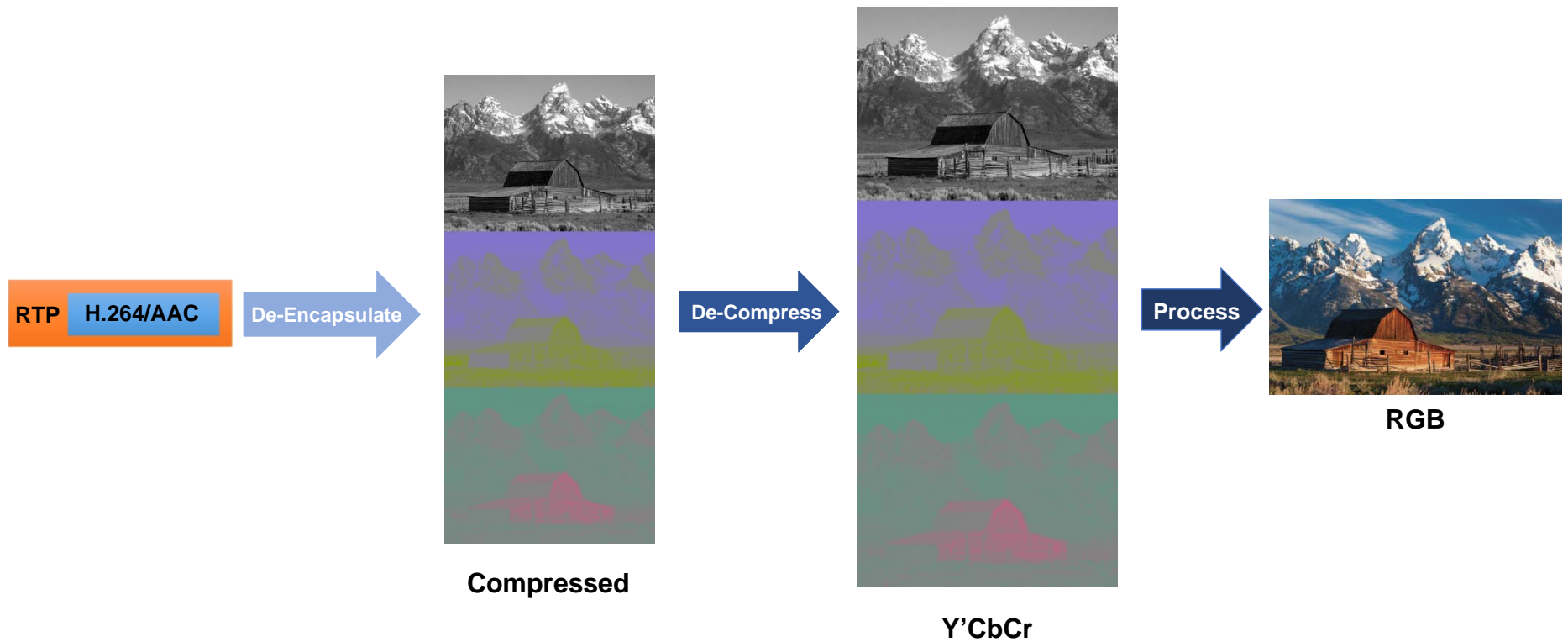

Encoding Considerations

- Sampling
- Color space conversion RGB to Y'CbCr
- Chrominance subsampling
- Bit depth

Encoding processes affect quality



2018 BICSI Fall Conference & Exhibition



Bicsi

Color Bit Depth

- 24-bit color allocates 8 bits per channel for both RGB and Y'CbCr color space
 - $8 \times 3 = 24$ -bit color

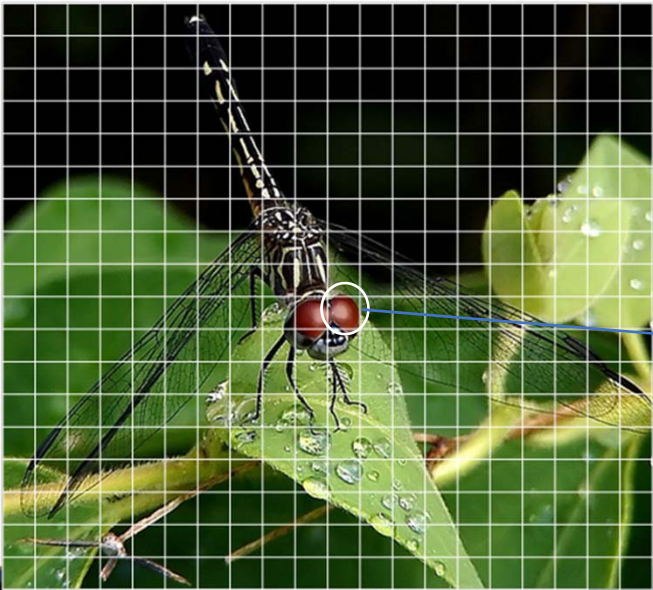

Range for each color = 0-255 or 256

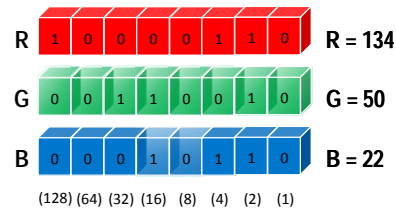

Counting in Binary

- Each pixel is represented by 3 groups of 8 bits, for a total of 24 bits
- Each group can represent up to 256 colors
- The sum of all 3 groups (colors) are able to represent 256^3 or 16,777,216 colors



Example Chrominance Subsampling

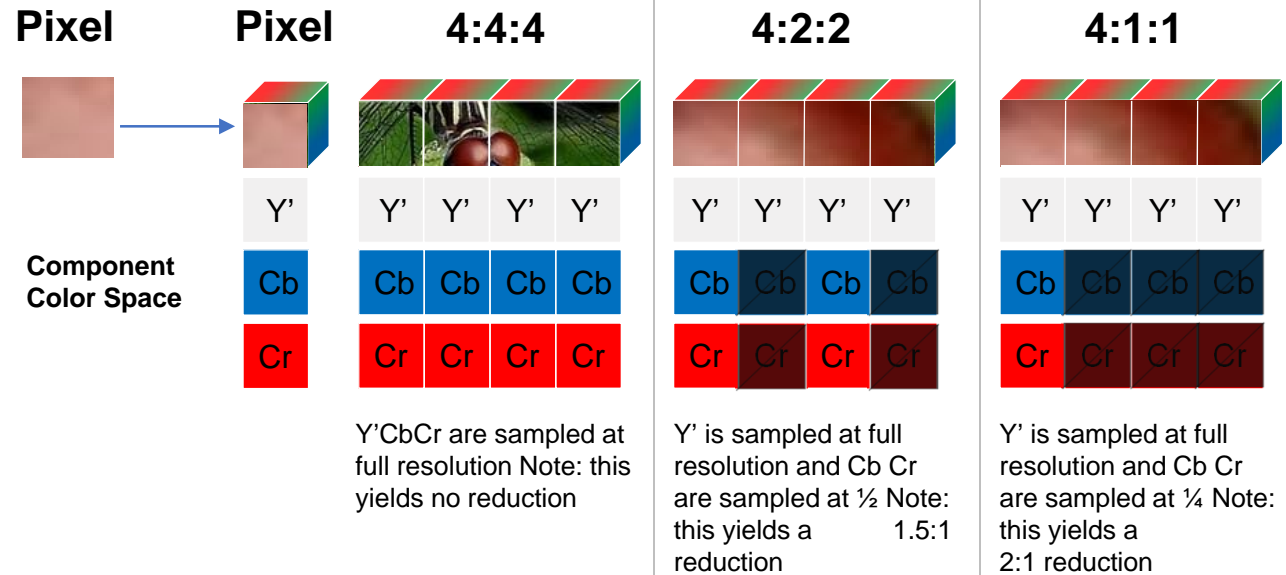

Compression Artifacts

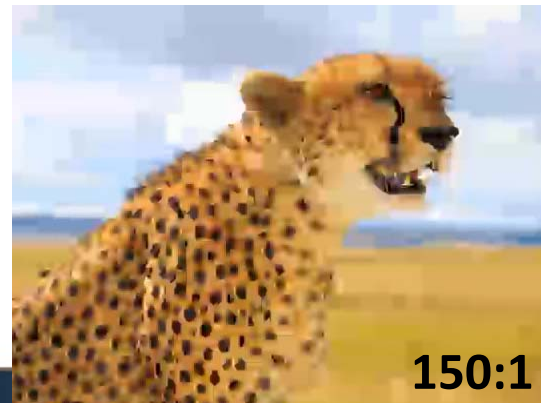
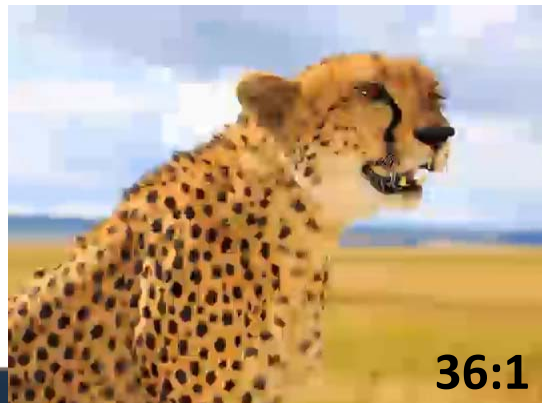

2018 BICSI Fall Conference & Exhibition



Bicsi

Compression Codecs

- Why are there so many different compression codecs?
 - They are developed for a variety of reasons
 - Commercial
 - Technical
 - Political



2018 BICSI Fall Conference & Exhibition



Bicsi

Many Considerations for Codec Selection

- Image Quality
- Streaming Latency
- Scalability Requirements – number of endpoints
- Network
 - Bandwidth Availability
 - Network QoS
- Compatibility
- Which requirements are more important?
- What is good enough?



2018 BICSI Fall Conference & Exhibition



Bicsi

Browser: Chrome | URL: https://www.youtube.com/watch?v=L3V7LKYPIUQ | Tab: Hawaii in 4K - Inspirational ...

YouTube Header: Search, Sign in

Video ID / CPN: L3V7LKYPIUQ / Hz0WwKc0MwB9W6
 Viewport: 640x360@1.0299999713897705
 Current / Optimal Res: 654x480@24 / 640x360@24
 Volume / Normalized: 100% / 66% (content loudness 3.7dB)
 Codec: evc1.4.401e (135) / mp4a.40.2 (140)
 Host: r6-sr-p5qlanz6

Connection Speed	62717 Kbps
Network Activity	0 KB
Buffer Health	89.67 s
Dropped Frames	0/28

Get Grammarly Free

Get Grammarly
Ad grammarly.com

Up next Autopla

- Bora Bora F Polynesia ir
JJ Adventures
1,240,974 view
6:21
- 10 Best Pla in Hawaii
World Top 10
30,387 views
10:48
- Honolulu, H Travel Guid- See Attracti
BookingHunter
891,035 views
4:07
- 4K Italy by Dro
Michael Levens
226,726 views
6:01
- 4k Hawaii D Footage
sawyerhartmar
5,392,292 view
11:11
- How I Met h
Out Less St

Hawaii in 4K - Inspirational Speech - Make Your Life Extraordinary!

devinsupertramp

3,876,796 views

+ Add to Share ... More

Published on Jan 24, 2017
 This speech will change your life! Hawaii captured like never before, in glorious 4K :)
 Watch our latest: <https://www.youtube.com/playlist?list...>
 Music & Speech by Fearless Motivation

SHOW MORE

COMMENTS • 2,600

Add a public comment...

Browser: Chrome | URL: https://www.youtube.com/watch?v=L3V7LKYPIUQ | Tab: Hawaii in 4K - Inspiration ...

YouTube Header: Search, SIGN IN

Video ID / CPN: L3V7LKYPIUQ / dHhJ4hn2femSke5X
 Viewport: 640x360@1.25
 Current / Optimal Res: 3840x2160@24 / 3840x2160@24
 Volume / Normalized: 7% / 5% (content loudness 3.7dB)
 Codec: vp9 (313) / opus (251)
 Host: r6-sr-p5qs7nek

Connection Speed	58973 Kbps
Network Activity	0 KB
Buffer Health	14.47 s
Dropped Frames	0/153

Hawaii in 4K - Inspirational Speech - Make Your Life Extraordinary!

3,876,796 views

devinsupertramp

Published on Jan 24, 2017

This speech will change your life! Hawaii captured like never before, in glorious 4K :)
 Watch our latest: <https://www.youtube.com/playlist?list...>
 Music & Speech by Fearless Motivation

SHOW MORE

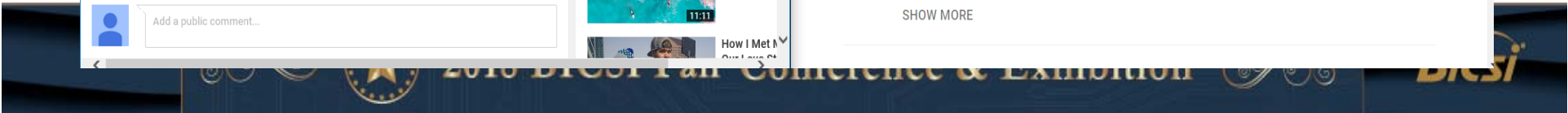

H. 264 vs H.265

- is a block-oriented motion-compensation-based video compression standard.

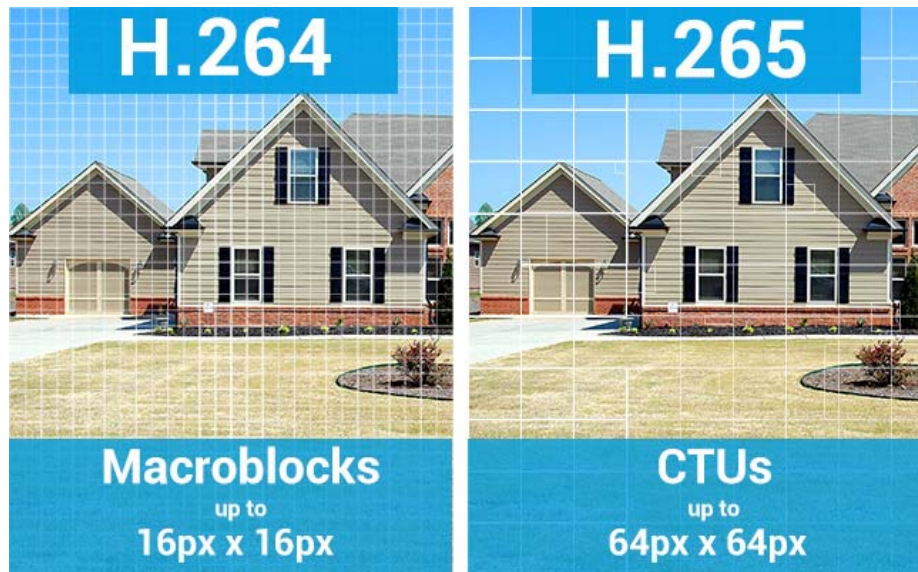

H. 264 vs H.265

- the intent of the H.264/AVC project was to create a standard capable of providing good video quality at substantially lower bit rates than previous standards

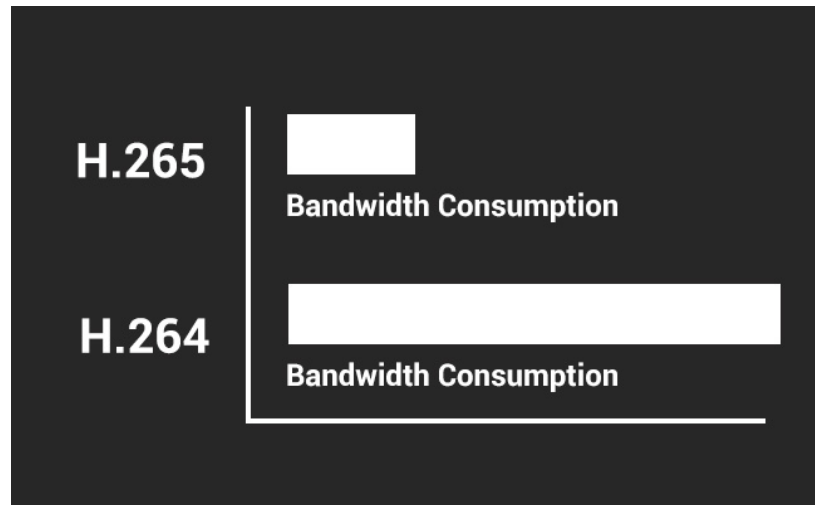

Image Quality – Considerations

- Viewing device – screen size
- Uninterrupted quality – error concealment
- Resolution – maintain native or reduced
- Production environment – editing, broadcast, studio



Non-critical



Critical

Latency



2018 BICSI Fall Conference & Exhibition



Bicsi

Latency – Considerations

- The amount of delay can vary based on:
 - Compression and encoding method
 - Network environment: Private, Public
- Delay can be important or unimportant to the application

Low Latency “Interaction”	High Latency “Accessibility, One-way”
<ul style="list-style-type: none">• Interactive:<ul style="list-style-type: none">• Real-time communication• Collaboration• Control equipment remotely• Mission critical and Life safety	<ul style="list-style-type: none">• Availability:<ul style="list-style-type: none">• Broad range of users• Across the Internet• Variety of endpoints – PCs, Mobile devices• Immediacy or “on demand”



Network Paths

Identifying the Operating Boundries



2018 BICSI Fall Conference & Exhibition



Bicsi

What Kind of Network Will I Be Streaming On?

Enterprise Streaming

- Streaming is co-mingled with data and voice traffic
- Building or campus LAN
- Streaming occurs inside the Enterprise



Public Networks

- Streaming is delivered outside the firewall
- Internet or public network provider is used
- VPN – Virtual Private Network may be used

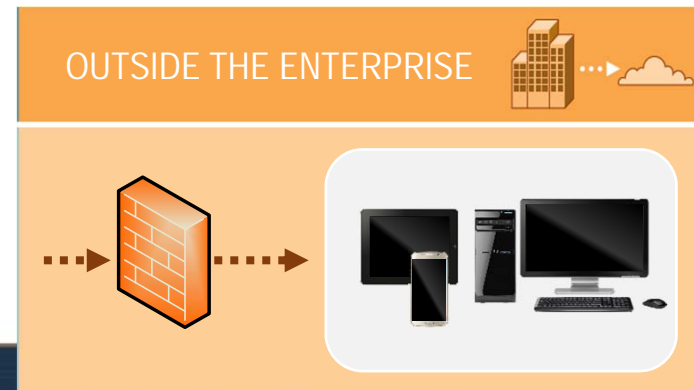

CDN Providers

Amazon barges into the content delivery network business

September 18, 2008 | Dean Takahashi

[Add a Comment](#)



When you've got computing infrastructure like Amazon does, it's a competitive weapon. Amazon is proving that today by using its infrastructure to launch a new business in content delivery. In doing so, it is aiming squarely at rivals such as Akamai Technologies and Limelight Networks.

Content delivery networks set up servers across geographies that can deliver network-clogging data such as videos. They prevent Internet traffic jams by positioning the video servers closer to consumers who are doing the downloading.



Previously, Seattle-based Amazon showed how it could use its data centers — built to serve the mainstay Amazon.com e-commerce business — to launch Amazon Web Services, which hosts sites for other companies. Its S3 storage service and EC2 on-demand computing services can help start-ups get off the ground by outsourcing the web hosting and storage chores that small businesses don't want to deal with.

Amazon said the service will be available later this year in North America, Europe and Asia. Smaller web sites that use lots of voice, video or graphics could tap Amazon to ensure that they can deliver high-quality



2018 BICSI Fall Conference & Exhibition



Common Transport Protocols



2018 BICSI Fall Conference & Exhibition



Bicsi

What is HTTP Tunneling Streaming?

- HTTP tunneling is the process in which communications are encapsulated by using HTTP protocol
- An HTTP tunnel is often used for network locations which have restricted connectivity or are behind firewalls or proxy servers

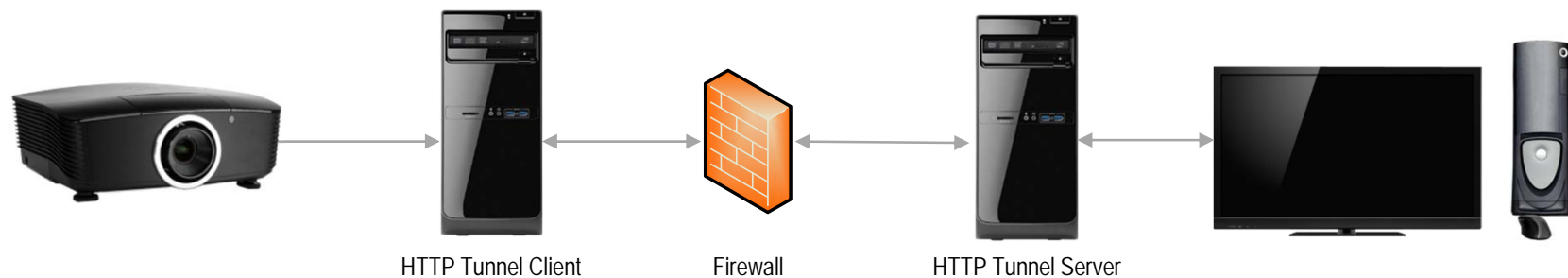

What is RTSP Streaming

- Real Time Streaming Protocol (RTSP) is a network control protocol designed for use in entertainment and communications systems to control streaming media servers
- It works like a remote control for media streaming



Data Rate?

Resolution?

Audio?



2018 BICSI Fall Conference & Exhibition



Bicsi

RTMP Push Streaming and its benefits

- RTMP Push Streaming allows content to be pushed to a CDN (Content Delivery Network) to wait for a client to request it
- This uses 0 bandwidth until it is requested
- This allows content to pass through the local firewall and remain available until it is requested



2018 BICSI Fall Conference & Exhibition



Bicsi

Streaming to YouTube Live

1. Go to www.youtube.com and log in to your account.
2. Click on the  **Upload** button on the top right corner
3. Click on the **Get started** button of Live Streaming

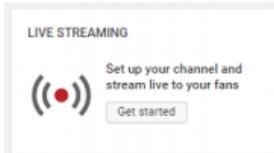

4. There are two options for live streaming:

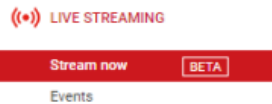

- A. **Stream now** - for instant live streaming – see step 5
- B. **Events** - to scheduled live events – see step 12

- A. For **Stream Now** page, enter basic information about the live stream, and scroll down to the Encoder Setup:

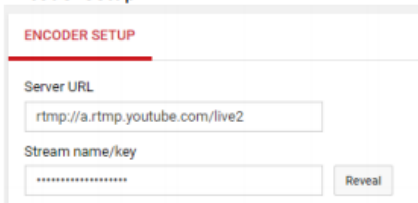
A screenshot of the YouTube Encoder Setup form. It has a title "ENCODER SETUP" and two input fields: "Server URL" with the value "rtmp://a.rtmp.youtube.com/live2" and "Stream name/key" with a masked value "*****". There is a "Reveal" button next to the Stream name/key field.

1. Copy and paste the **Server URL** and **Stream Name/key** to the SMP Streaming data fields, then **Click Apply**.
2. On the SMP Streaming, click "Start RTMP stream" button to activate the stream.
3. After a few seconds, the button will change to red and indicate the RTMP stream is now live.



4. Back on the YouTube live dashboard page, you should now see the display of the SMP streaming content and the content is live.

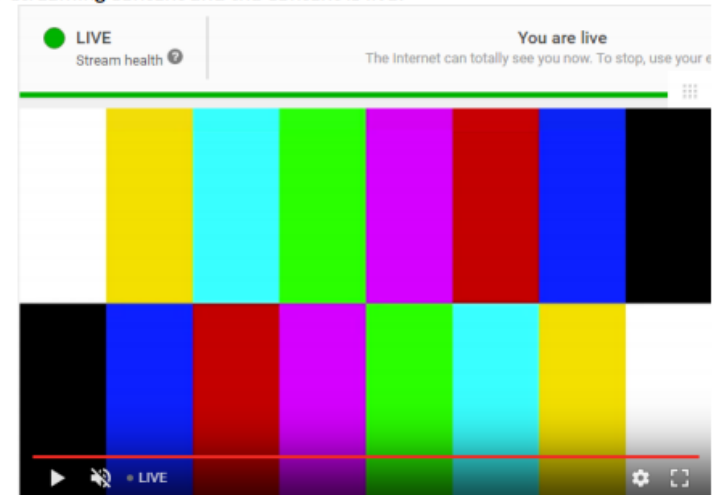

5. The live stream will be available on YouTube until it is stopped from the SMP streaming page or SIS command.



Note: YouTube does not require Username and Password for Live Stream. YouTube uses port 1935 for streaming. This port must be open for network access.

- B. For **Events** workflow on the Youtube page:

1. Click **New live event** to start a new event

A screenshot of the YouTube Events workflow. It shows an "Events" section with a "New live event" button highlighted in red. There are also "Actions" and "View" dropdown menus.

2. Enter the event **Title**, **Start Date/Time**, and a **Description**.
3. Click **Create Event**

Designs



2018 BICSI Fall Conference & Exhibition



Bicsi

Small Meeting Room



AV Requirements

- AV Sources
- Multiple Laptops
- Output Devices
- 4K Display

Technical Requirements

- Users will have ability to connect to system with laptops using HDMI, DisplayPort, or VGA
- Auto-switching between inputs
- System will use internal speakers of display for Audio support



Small Meeting Room

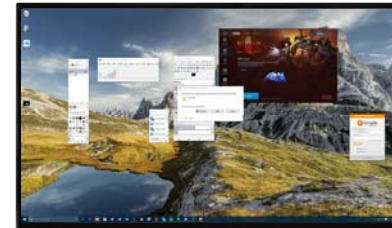

2018 BICSI Fall Conference & Exhibition



Bicsi

Small Meeting Room

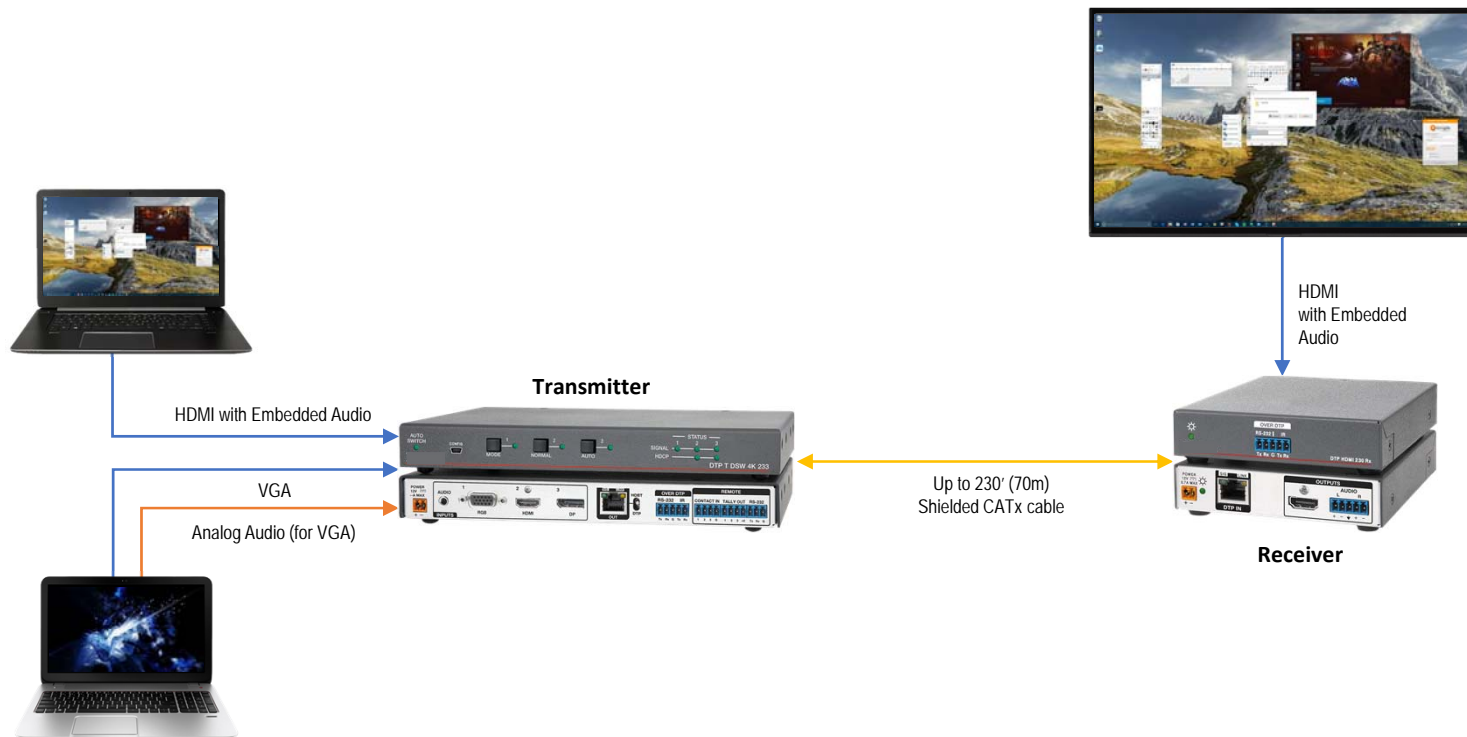

Small Meeting Room



Executive Meeting Room

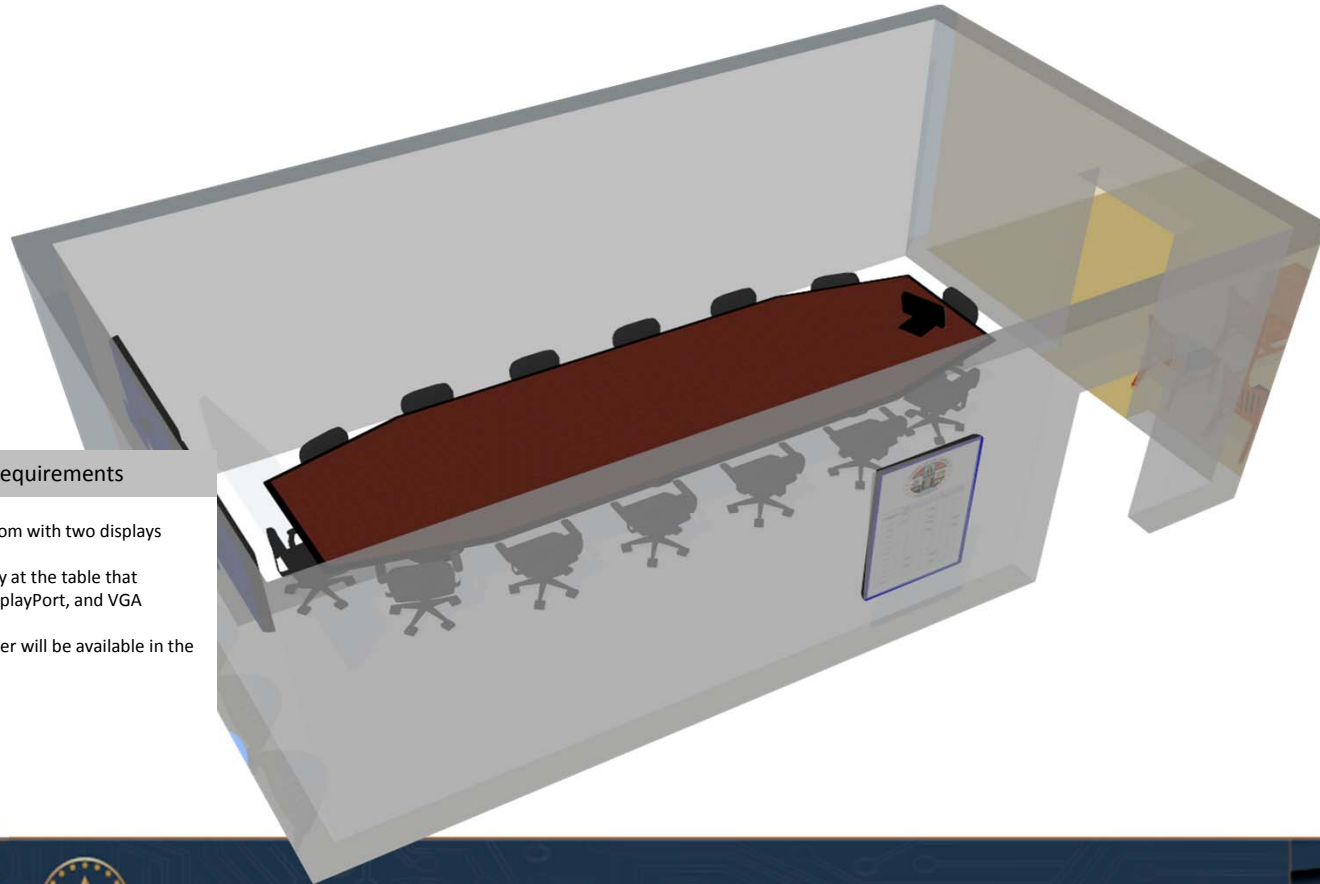

Technical Requirements

- Elegant meeting room with two displays
- Diverse connectivity at the table that supports HDMI, DisplayPort, and VGA
- PC and Blu-ray player will be available in the room



2018 BICSI Fall Conference & Exhibition



Bicsi

Executive Meeting Room

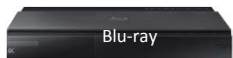

2018 BICSI Fall Conference & Exhibition



Bicsi

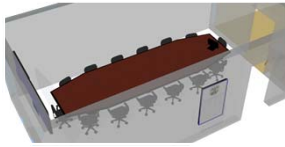

Control

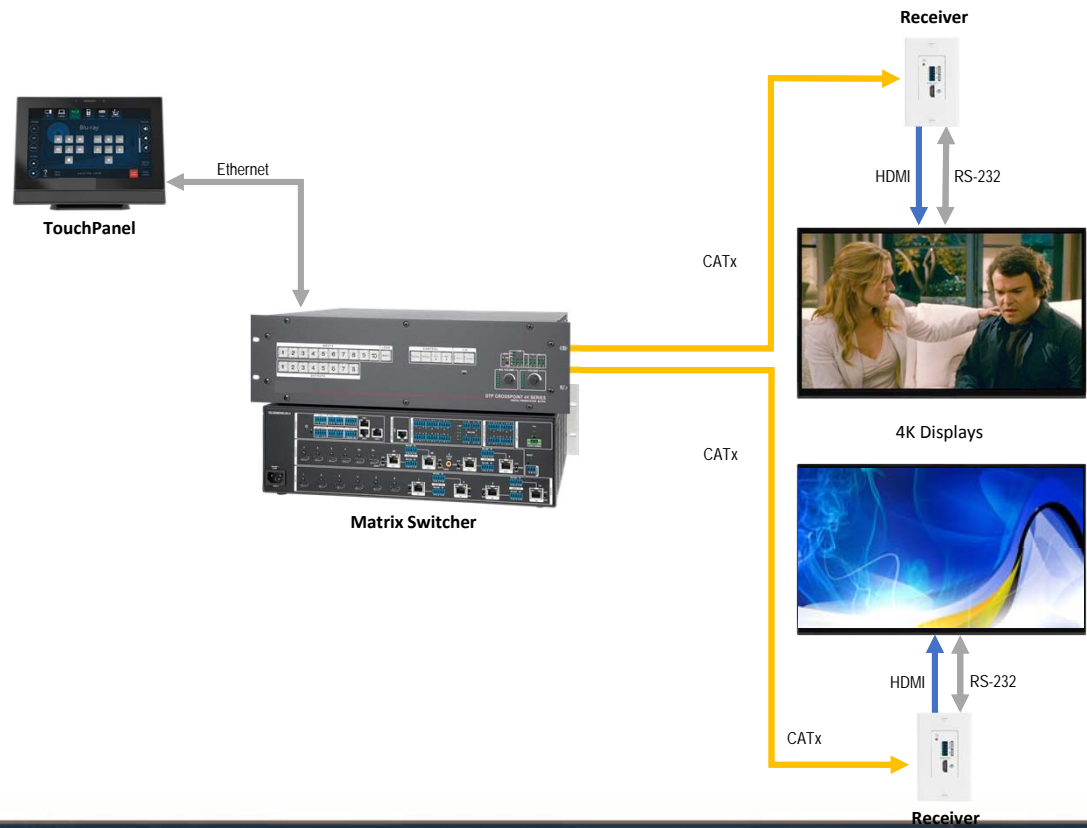

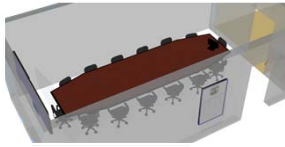

Transport

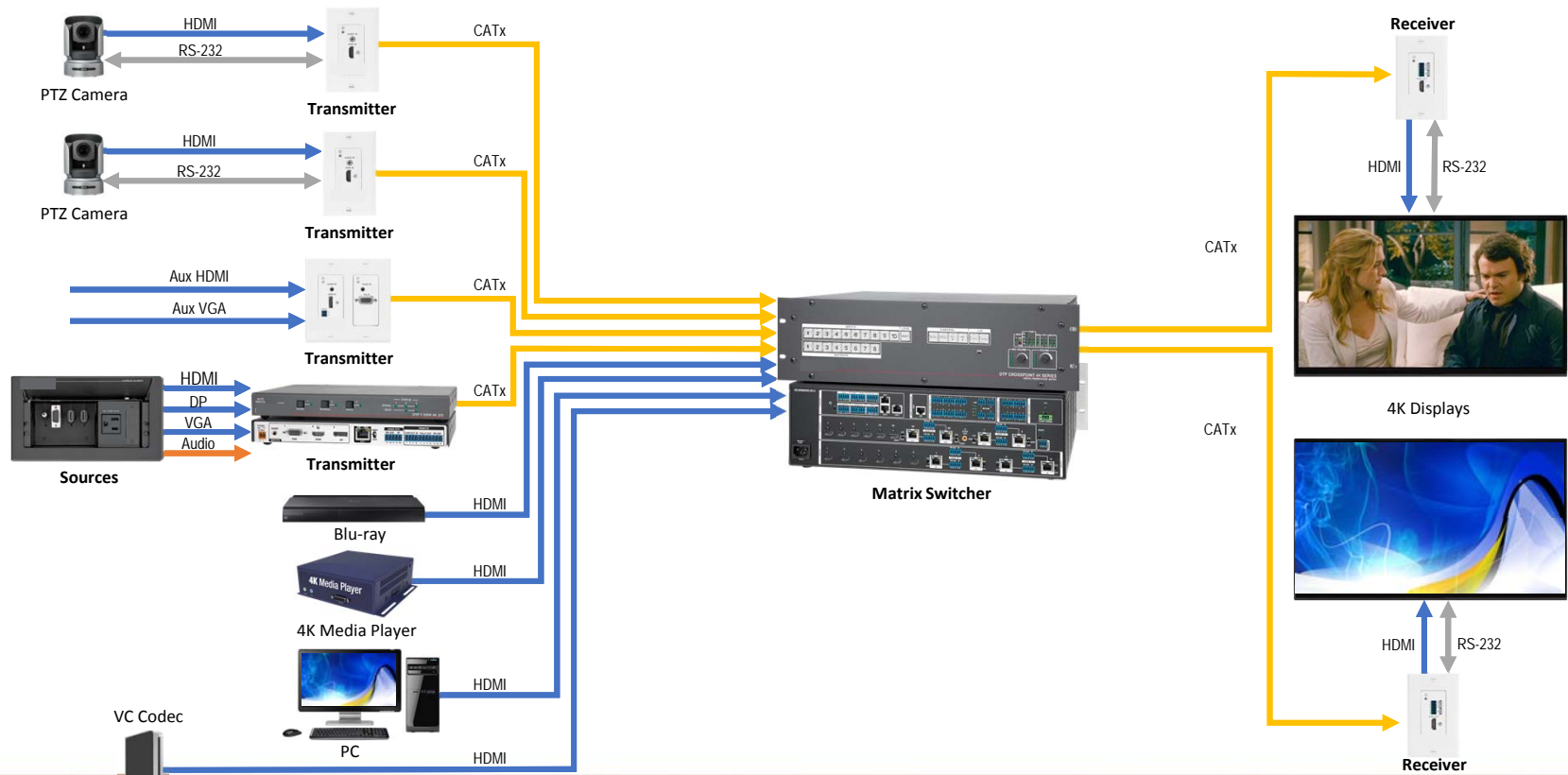

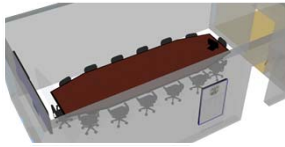

All aspects

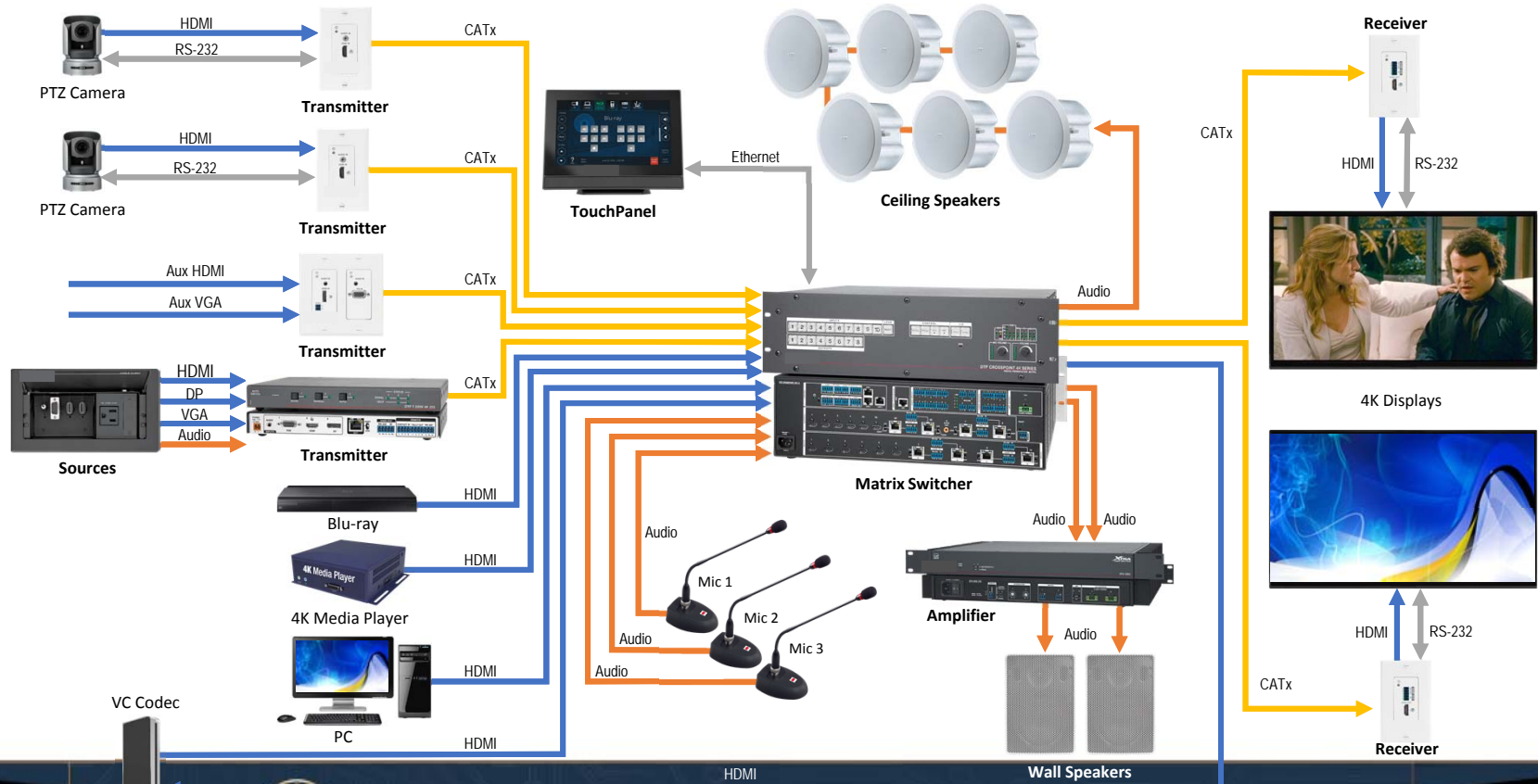

Lecture Hall

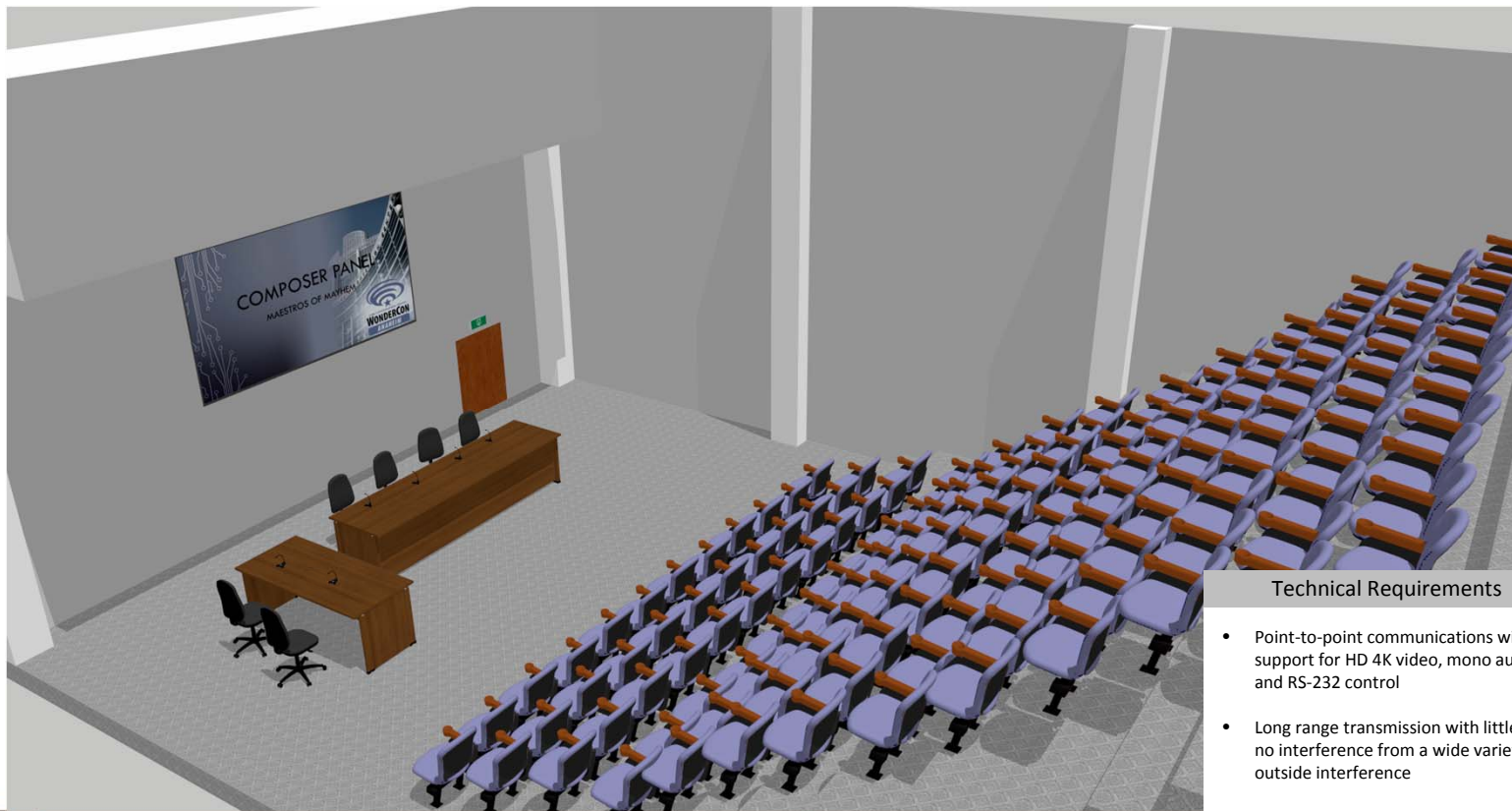

Technical Requirements

- Point-to-point communications with support for HD 4K video, mono audio, and RS-232 control
- Long range transmission with little or no interference from a wide variety outside interference



Lecture Hall

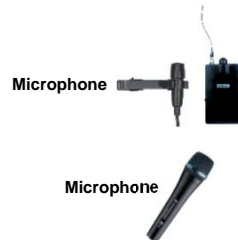

Projector - 1920x1200



Motorized Screen



Display - 1080p

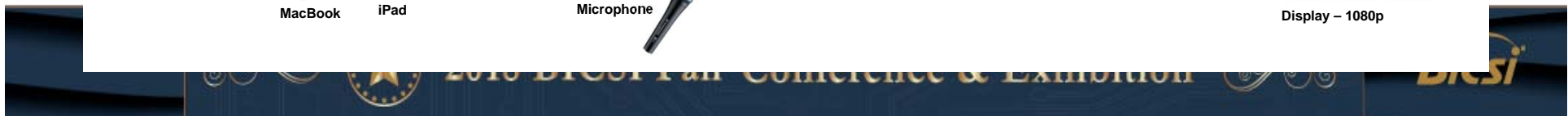

Lecture Hall

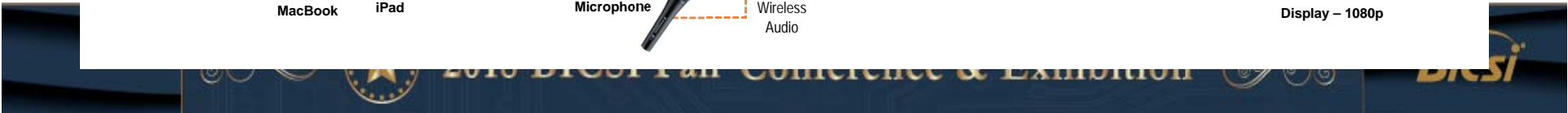
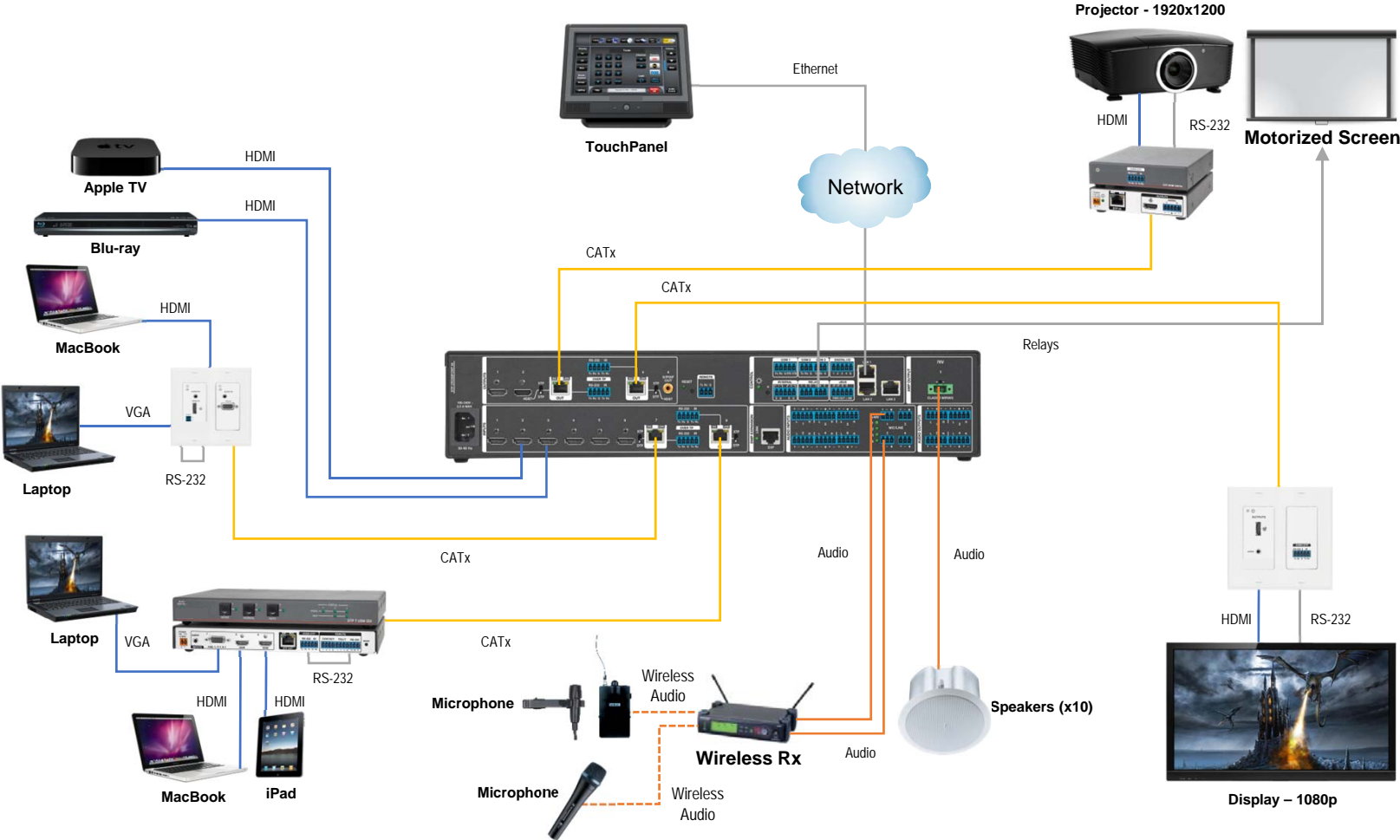

Church Streaming



Technical Requirements

- Audio and Video recording with displays used for presentation, information, and digital signage
- Streaming capabilities with live content sent to a lobby display, internal and external streaming servers



2018 BICSI Fall Conference & Exhibition



Bicsi

Church Streaming

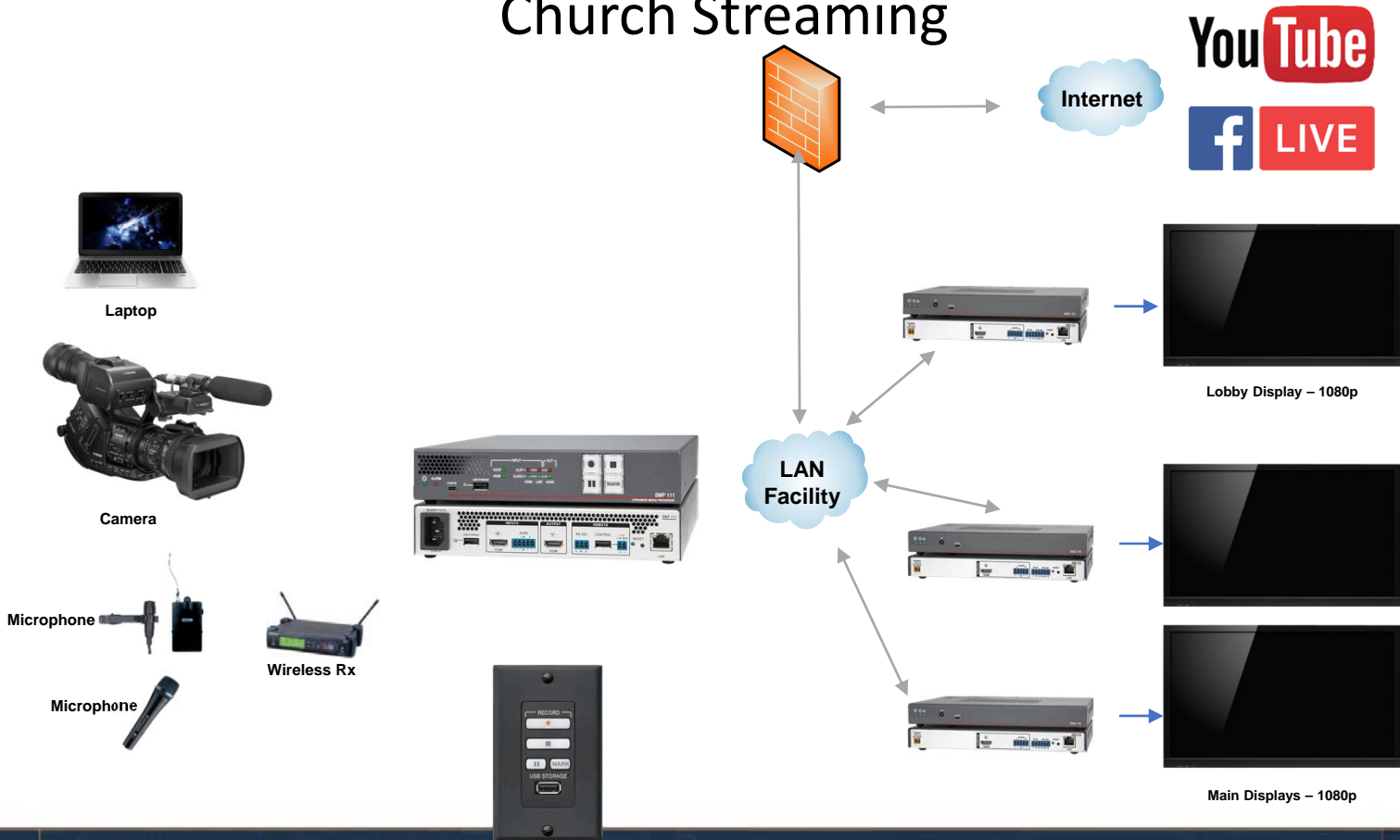

Lecture Application

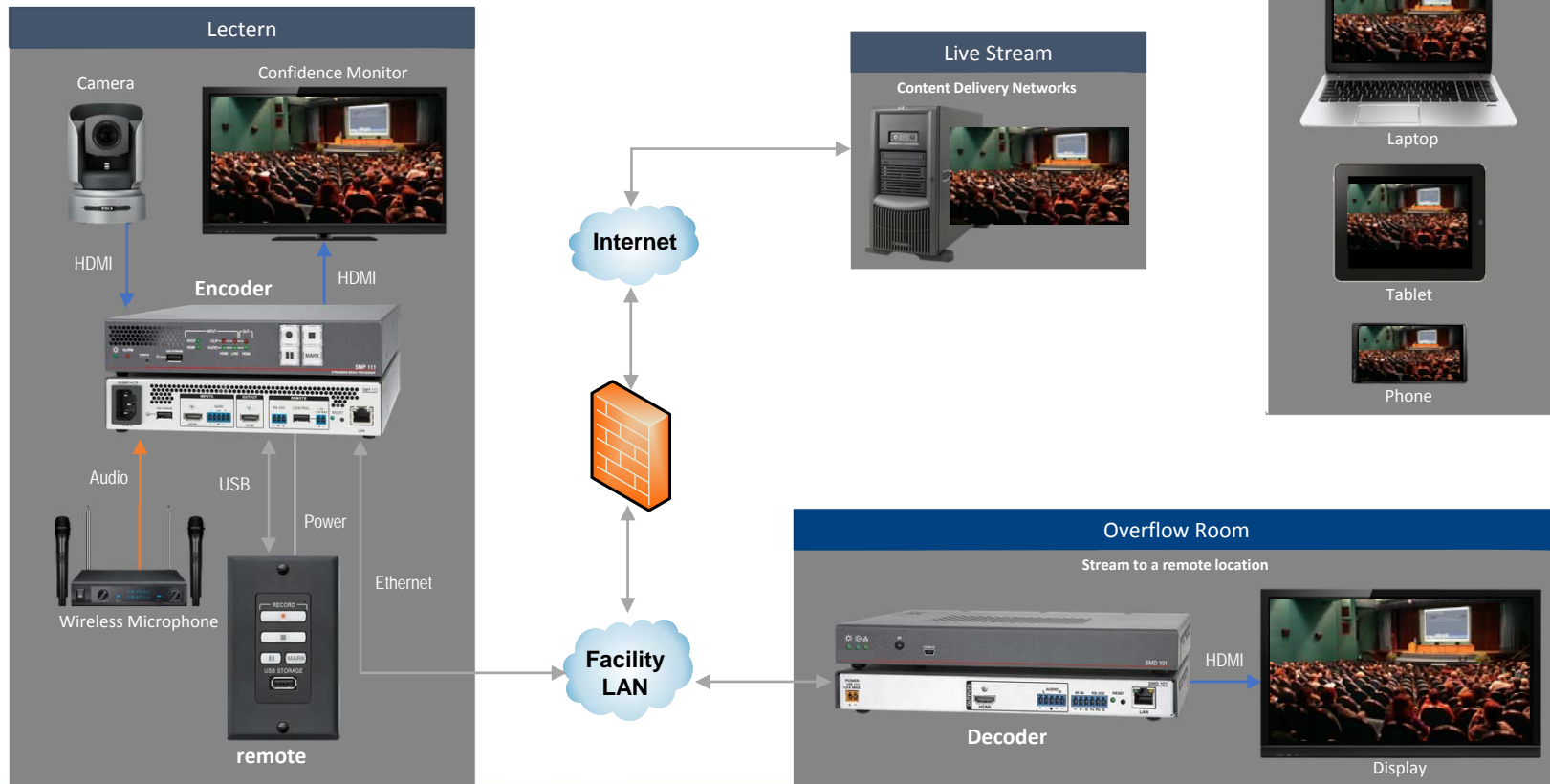

Keys to Video on a Network “infrastructure”

- Uncompressed using CAT6 or Fiber
- Wireless Gateway understanding latency and compression
- AV over IP
- Streaming and Understanding Codec Use
 - Image Quality
 - Latency
 - Data Rate



2018 BICSI Fall Conference & Exhibition



Bicsi

When a Network is No Longer Just a Network

Thank You



2018 BICSI Fall Conference & Exhibition



Bicsi